

# Table of Contents

<b>Introduction .....</b>	<b>9</b>
Product Description .....	9
Overview .....	10
<b>Important Safety Instructions .....</b>	<b>11</b>
<b>Foreign Language Warnings - German .....</b>	<b>14</b>
<b>Foreign Language Warnings - French .....</b>	<b>17</b>
<b>Declaration of Conformity .....</b>	<b>20</b>
<b>Setup .....</b>	<b>21</b>
Unpacking .....	21
Connection Instructions .....	22
Basic Setup .....	22
Studio Setup .....	23
Power Up! .....	24
Instant Gratification.....	25
Playing Demo Sequences .....	25
Auditioning Presets .....	25
Selecting and Quick Editing Presets .....	26
Playing BEATS .....	28
Exploring the Master Arpeggiator .....	30
Multi-Channel Arpeggiator .....	31
<b>Basic Operations .....</b>	<b>33</b>
Front Panel.....	33
Volume Control .....	33
Master Button .....	33
Edit Button .....	33
Control Button .....	33
Audition Button .....	34
Left/Right Cursor Buttons .....	34
Save/Copy Button .....	34
Home/Enter Button .....	34
Data Entry Control .....	35

## Table of Contents

Front Panel Controller Modes .....	35
Real-time Control .....	35
Quick Edit .....	36
Deep Edit Mode .....	36
Main Screen.....	38
MIDI Channel Selection .....	38
Preset Selection .....	38
Channel Volume .....	39
Channel Pan .....	40
Channel Arpeggiator .....	40
Sound Navigator.....	41
Preset Category .....	41
Instrument Category .....	41
Multitimbral Operation .....	42
<b>Arpeggiator/Beats Menu .....</b>	<b>43</b>
Base Tempo .....	44
SuperBEATS .....	44
BEATS Mode .....	46
BEATS Controllers .....	48
Beats Trigger Layout .....	50
Beats Trigger Offset .....	51
Beats Part Velocity .....	51
Beats Part Transpose .....	52
Beats Part Group .....	53
Master Riff .....	53
Riff Tempo .....	54
Riff Controllers .....	54
MIDI Song Start .....	55
Arp/Riff MIDI Out .....	55
Arpeggiators .....	56
Arp Controllers .....	57
Master Arpeggiator Parameters .....	57
Status .....	58
Mode .....	58
Note Value .....	59
Arpeggiator Pattern Speed .....	59
Pattern .....	59
Velocity .....	60
Gate Time .....	60
Extension Count .....	61
Extension Interval .....	61
Sync .....	62
Pre-Delay .....	62
Duration .....	63
Post-Delay .....	63

Recycle .....	64
Keyboard Thru .....	64
Latch .....	64
Key Range .....	65
Send MIDI System Exclusive Data .....	65
Editing a User Arpeggiator Pattern .....	66
Pattern Step Number .....	66
Key .....	66
Velocity .....	68
Duration .....	68
Repeat .....	68
User Pattern Name .....	69
Multi-Channel Arpeggiating .....	70
Using a MIDI Interface to Channelize Data .....	71
<b>Master Menu .....</b>	<b>73</b>
Defining Master Parameters .....	74
Transpose/Tune .....	74
Bend Range .....	74
Velocity Curve .....	75
Mix Output .....	75
Master Effects .....	77
Effects Mode .....	77
Effects Multi Mode Control .....	77
Master FXA Algorithm .....	78
FXA Parameters: Decay/HF Damping FxB -> FxA .....	79
FXA Send Amounts .....	79
Master FXB Algorithm .....	79
FXB Parameters: Feedback/LFO Rate Delay Time .....	80
FXB Send Amounts .....	80
MIDI Parameters .....	81
MIDI Mode .....	81
MIDI SysEx ID .....	81
MIDI Enable .....	82
MIDI Program Change -> Preset .....	82
Receive Program Change .....	83
Real-time Controller Assignment .....	83
MIDI Footswitch Assign .....	84
Tempo Controller .....	85
Knob Preset Quick-Edit .....	85
Knobs Deep Edit .....	86
Knobs/Riff MIDI Out .....	86
Preset Edit All Layers Enable .....	86
Front Panel Knob Calibration .....	87
MIDI SysEx Packet Delay .....	88
Send MIDI System Exclusive Data .....	88
User Key Tuning .....	90

## Table of Contents

Screen Viewing Angle .....	90
<b>Programming Basics .....</b>	<b>91</b>
Modulation.....	92
Modulation Sources .....	93
Random Sources	94
Modulation PatchCords .....	94
Envelope Generators.....	95
Low Frequency Oscillators (LFOs).....	97
Clock Modulation .....	98
Modulation Destinations.....	100
Modulation Processors.....	101
Preset Modulation Processors.....	103
Using the Modulation Processors .....	105
More Examples .....	107
Dynamic Filters .....	109
What is a Filter? .....	110
Parametric Filters .....	113
The Z-Plane Filter .....	114
Signal Flow .....	115
MIDI Channels & Real-time Controls.....	116
Bank Select Commands .....	118
Stereo Mix Outputs .....	119
<b>Edit Menu .....</b>	<b>121</b>
Preset Name .....	122
Four Layer Architecture .....	123
Selecting Layers .....	123
Defining Layer Parameters .....	124
Selecting an Instrument .....	124
Defining Key Range .....	125
Defining the Velocity Crossfade Range .....	128
Defining the Real-time Crossfade Range .....	130
Transposing the Instrument .....	133
Tuning .....	134
Amplifier .....	134
Volume Envelope .....	135
Chorusing the Layer .....	137
Sound Start Offset and Delay .....	137
Non-Transpose Mode .....	138
Solo Mode .....	138

Assign Group.....	139
Glide .....	140
Z-Plane Filters .....	140
Xtreme Lead Filter Types .....	141
Filter Envelope .....	143
Auxiliary Envelope .....	145
Low Frequency Oscillators (LFOs) .....	145
PatchCords .....	150
Pitch Bend Range .....	153
Mix Output .....	153
<b>Common Preset Parameters .....</b>	<b>154</b>
Preset Effects .....	154
FXA Algorithm .....	156
FXA Parameters .....	157
FXA Send Amounts .....	157
FXB Algorithm .....	157
FXB Parameters .....	158
FXB Send Amounts .....	158
Preset Patchcords .....	159
Initial Controller Amount .....	160
Keyboard Tuning .....	161
Preset Links .....	163
Preset Tempo Offset .....	164
Audition Riff Selection .....	164
Play Solo Layers .....	164
<b>Programming Tutorial .....</b>	<b>165</b>
Editing Presets.....	165
Changing the Instrument .....	165
Changing the Tuning of an Instrument .....	166
Chorus .....	167
Volume Envelope .....	167
Working with Filters .....	169
Practice Modulating .....	173
Troubleshooting .....	174
Linking Presets .....	175
<b>Effects .....</b>	<b>177</b>
Effects Overview.....	177
The Effects Sends .....	177
Effect Types.....	179
Effect Parameters .....	179
Effects Programmed in the Preset.....	181
Master Effects.....	182
Effects Mode .....	184

## Table of Contents

Flexible Effects Control .....	184
Effect B Into Effect A .....	186
<b>General Effect Descriptions .....</b>	<b>188</b>
Reverb .....	188
Chorus .....	189
Doubling .....	189
Slapback .....	189
Stereo Flanger .....	189
Delay .....	190
Stereo Delay .....	190
Panning Delay .....	190
Dual Tap .....	190
Vibrato .....	190
Distortion .....	190
<b>Save/Copy Menu .....</b>	<b>191</b>
Saving a Preset.....	191
Copying Information.....	192
Copy Preset .....	192
Copy Layer .....	192
Copy PatchCords .....	193
Copy Preset PatchCords .....	194
Copy Arpeggiator Settings .....	194
Copy Arpeggiator Pattern .....	195
Copy Preset Bank .....	195
Multisetups.....	196
Restoring Multisetups .....	196
Multisetup Name .....	197
Saving Multisetups .....	197
Create Random Preset .....	198
Copy User Bank to Flash .....	199
Rename Flash SIMM .....	200
Duplicate Flash .....	201
<b>Appendix .....</b>	<b>203</b>
Front Panel Knob Functions .....	203
Presets .....	204
XL-1 Preset Categories .....	204
Preset Listing.....	205
Riff Listing.....	209
Instrument Listing.....	211
Trigger Layouts .....	221
Trigger Layout 1 .....	221

Trigger Layout 2 .....	222
Trigger Layout 3 .....	222
Trigger Layout 4 .....	223
Velocity Curves.....	224
PatchCord Amount Chart.....	226
MIDI .....	227
Received Channel Commands .....	229
SysEx Specification .....	229
Technical Specifications.....	230
Warranty .....	231
Warranty .....	231
Warranty Restrictions .....	231
How To Obtain Warranty Service .....	231
<b>Index .....</b>	<b>233</b>

## Table of Contents





# Introduction

## Product Description

Congratulations on your purchase of the Xtreme Lead-1 (*or XL-1 for short*). XL-1 is a new synthesizer/sound module with an array of new dynamic and rhythmic features not found in any other instrument. Xtreme Lead was designed for live *performance*, so make sure to try out all the controller knobs on each preset. And as you'll soon discover, Xtreme Lead is a total kick to play.

Xtreme Lead's sound set consists primarily of analog, noise and modern synthesizer waveforms. These sounds are rich in harmonic texture and are perfectly matched to the *XTREME* filters.

Xtreme Lead contains two user-upgradable sound SIMM sockets, allowing you to mix and match sound sets according to your needs. New sounds can be added as easily as plugging in a new 16MB or 32MB SIMM module. Each E-MU sound set has been meticulously crafted to be the finest of its kind. Samples are matched across the keyboard, perfectly looped, and rich in harmonic texture.

XL-1 contains 512 user presets and can hold literally thousands of factory presets. (*ROM presets are automatically added when sound SIMMs are installed. As an example, a 32 MB SIMM may contain up to 1024 ROM presets.*) Xtreme Lead's Sound Navigator makes it easy to find the exact sound you want. It's powerful, yet simple to use.

XL-1 introduces E-MU's SuperBEATS Mode, which is a whole new way to create dynamic, original music. With SuperBEATS, you trigger, latch and unlatch synced loops and grooves from your keyboard. Select a BEAT, select a preset and go. Then use XL-1's performance controls to alter and mutate the rhythm or the sound itself.

Then there's XL-1's revolutionary Rhythmic Pattern Generator/Arpeggiator which can play up to 16 synchronized arpeggiator patterns at once using a different sound for each! Patterns can be edited using pattern flow commands such as: delay for 2 bars, play for 4 bars, hold for 2 beats and repeat. You can program or download 100 user patterns in addition to the 200 factory patterns.

The extremely flexible yet easy to use 4-layer synthesizer voices make it easy to build sounds of any kind. Layers can be switched or crossfaded using key position, velocity, real-time controllers or any modulation source. Xtreme Lead also contains 50 different 12th order resonant & modeling filters which are used to shape and modify over 1200 waveforms contained in 32 megabytes (MB) of ROM.

64 modulation sources include three multistage envelopes and two LFOs per layer, as well as full MIDI control over virtually every parameter. The digital patch bay, with 24 cords per layer, (and 12 more cords per preset) lets you connect modulation sources to 64 destinations in any imaginable way. The patch bay contains a set of arithmetic modifiers, letting you create complex synthesis models. Synth parameters as well as arpeggiator and BEAT tempos can be controlled from XL-1's internal clock (or an external MIDI clock). Up to 8 LFOs and 12 envelopes can be perfectly synchronized at different rates. This is an extremely powerful synthesizer!

Four front panel real-time controllers give you control over 12 user-selectable parameters. The real-time knobs can adjust multiple parameters at once, allowing complex levels of control. For example, one knob can simultaneously turn up filter cutoff, while detuning one sample, and adjusting the release time of the volume envelope. Virtually every synth parameter in the XL-1 is controllable using the real-time knobs or by any internal or external control source.



*The optional **Turbo** upgrade adds the following features to your XL-1:*

- 128 voice polyphony
- 4 submix analog outputs
- 32 MIDI channel operation
- 2 additional sound ROM slots
- S/PDIF stereo digital output

Once you have created your preset, you can add richness to your sound using XL-1's 24-bit stereo effects. You can choose a different effects setup for each preset from over 60 algorithms. XL-1's effects section is actually two separate effects processors with control over each wet/dry mix level on four effects sends. Effects Processor "A" contains primarily ambiance algorithms like reverb and delays, while effects processor "B" contains primarily spectral algorithms such as chorus, flange, phase, distortion, and delay. Effects can be linked to each preset or used globally to further enhance your sound.

Other features include multiple solo, voice assignment and performance modes for expressive control, 12 user-definable alternate tunings, and, of course, an extensive MIDI implementation.

## Overview

This is the Getting Started Manual for setting up and playing Xtreme Lead. The first part of the manual describes how to unpack and setup the hardware. The next chapters provide step-by-step instructions for the most common and widely used features of Xtreme Lead. This section also defines each of the parameters and provides information on how to use them.

The complete operation manual is provided to you in pdf format on CD-ROM. The CD-ROM contains pdf files for both Mac and PC as well as the complete MIDI SysEx specification and a software downloading tool which allows you to retrieve the latest software and new features from the world wide web.

# *Important Safety Instructions*

## **Grounding Instructions**

Use in countries other than the U.S.A. may require the use of a different line cord or attachment plug, or both. To reduce the risk of fire or electric shock, refer all servicing to qualified service personnel. Do not expose this product to rain or moisture. There are no user serviceable parts or adjustments inside the unit.

This product must be grounded. If it should malfunction or break down, grounding provides a path of least resistance for electric current, reducing the risk of electric shock. This product is equipped with a cord having an equipment-grounding conductor and a grounding plug. The plug must be plugged into an appropriate outlet properly installed and grounded in accordance with all local codes and ordinances.

## **Danger!**

Improper connection of the equipment's grounding conductor can result in the risk of electric shock. Check with a qualified electrician or service personnel if you are in doubt as to whether the product is properly grounded. Do not modify the plug provided with this product. If it will not fit the outlet, have a proper outlet installed by a qualified technician.

## **Caution!**

If your Xtreme Lead (Model Number 9110) is rack mounted, you must use a standard 19 inch open frame rack. Screw-on rack mount ears are provided for this purpose.

## User Maintenance Instructions



*This symbol is intended to alert you to the presence of important operating and maintenance (servicing) instructions in the literature accompanying the unit.*

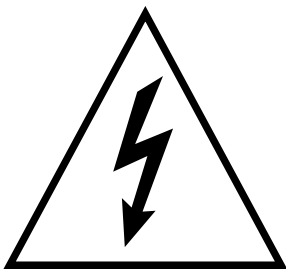

*This symbol is intended to alert you to the presence of uninsulated dangerous voltage within the product's enclosure that may be of sufficient magnitude to constitute a risk of electric shock to persons.*

1. The Xtreme Lead should be kept clean and dust free. Periodically wipe the unit with a clean, lint free cloth. Do not use solvents or cleaners.
2. There are no user lubrication or adjustment requirements.

**Caution** -. *These servicing instructions are for use by qualified personnel only. To reduce the risk of electric shock, do not perform any servicing other than that contained in these operating instructions unless you are qualified to do so. Refer all servicing to qualified service personnel.*

### INSTRUCTIONS PERTAINING TO A RISK OF FIRE, ELECTRIC SHOCK, OR INJURY TO PERSONS.

**READ THESE INSTRUCTIONS:** When using electric products, basic precautions should always be adhered to, including the following:

1. Read all instructions before using Xtreme Lead.
2. To reduce the risk of injury, close supervision is necessary when using Xtreme Lead near children.
3. Do not use Xtreme Lead near water — for example near a bathtub, washbowl, kitchen sink, in a wet basement, on a wet bar, or near or in a swimming pool. Do not expose the unit to drips or splashes.
4. The Xtreme Lead should be situated so that its location or position does not interfere with its proper ventilation.
5. The Xtreme Lead should be located away from heat sources such as radiators, heat registers, fireplaces, stoves, or ovens.
6. The Xtreme Lead should be connected only to a power supply of the type described in the operating instructions and marked on the product.
7. Care should be taken so that objects do not fall and liquids are not spilled into the enclosure of Xtreme Lead through openings.
8. This Xtreme Lead may be equipped with a polarized line plug (one blade wider than the other). This is a safety feature. If you are unable to insert this plug into the outlet, do not defeat the safety purpose of the plug. Contact an electrician to replace your obsolete outlet.
9. Protect the power cord from being walked on or pinched, particularly at plugs, convenience receptacles, and the point where they exit from the unit.
10. Unplug the Xtreme Lead from the power outlet during lightning storms or when left unused for a long period of time.
11. This product, in combination with an amplifier and headphones and speakers, may be capable of producing sound levels that could cause permanent hearing loss. Do not operate for a long period of time at a high volume level or at a level that is uncomfortable. If you experience any hearing loss or ringing in the ears, consult an audiologist.
12. Only use attachments and accessories specified by E-mu Systems.

13. The Xtreme Lead should be serviced by qualified service personnel when:
  - A. The power supply cord has been damaged; or
  - B. Objects have fallen, or liquid has been spilled into the unit; or
  - C. The unit has been exposed to rain; or
  - D. The unit has been dropped or the enclosure damaged; or
  - E. The Xtreme Lead does not operate normally or exhibits a marked change in performance.
14. All servicing should be referred to qualified service personnel.

## Save These Instructions.

## Radio and Television Interference

The equipment described in this manual generates and uses radio-frequency energy. If it is not installed and used properly—that is, in strict accordance with our instructions—it may cause interference with radio and television reception.

This equipment has been tested and complies with the limits for a Class B computing device in accordance with the specifications in Subpart J of Part 15 of the FCC rules. These rules are designed to provide reasonable protection against such interference in a residential installation. However, there is no guarantee that the interference will not occur in a particular installation, especially if a “rabbit ear” TV antenna is used.

If Xtreme Lead does cause interference to radio or television reception, you can try to correct the interference by using one or more of the following measures:

- Turn the television or radio antenna until the interference stops.
- Move Xtreme Lead to one side or the other of the television or radio.
- Move Xtreme Lead farther away from the television or radio.
- Plug Xtreme Lead into an outlet on a different circuit than the television or radio.
- Consider installing a rooftop antenna with a coaxial lead-in between the antenna and television set.

## ***Foreign Language Warnings*** **- German**

### **Wichtige Sicherheits- vorschriften**

In Ländern ausserhalb den U.S.A. können andere Kabel oder Stecker notwendig werden. Zur Verminderung des Risikos von Feuer oder eines elektrischen Schlages übergebe man den Service an qualifizierte Fachleute. Das Gerät niemals Regen oder Nässe aussetzen.

### **Erdungs- struktionen**

Das Gerät muss geerdet sein. Bei einem Defekt oder Ausfall bietet Erdung dem elektrischen Strom den Weg des geringsten Widerstandes und reduziert das Risiko eines Schlages. Dieses Gerät ist mit einem geerdeten Kabel und Stecker ausgerüstet. Der Stecker muss in eine passende, einwandfrei montierte und geerdete Steckdose in Übereinstimmung mit den örtlichen Vorschriften eingeführt werden.

### **Gefahr**

Unvorschriftsgemässer Anschluss des Gerätes kann zum Risiko eines elektrischen Schlages führen. Im Zweifelsfalle über die ordnungsgemässe Erdung soll ein qualifizierter Elektriker oder eine Serviceestelle beigezogen werden. Ändern Sie den mitgelieferten Stecker nicht. Sollte er nicht in die Steckdose passen, soll die einwandfreie Installation durch einen qualifizierten Techniker erfolgen.

### **Vorsicht**

Wird der Xtreme Lead (Modell Nummer 9110) in einem Rackgestell montiert, muss ein offener 19-Zollrahmen verwendet werden.

## Unterhaltsinstruktionen für anwender

### Vorsicht



Dieses Symbol weist den Anwender auf wichtige Gebrauchs- und Service-Vorschriften in den beiliegenden Drucksachen.

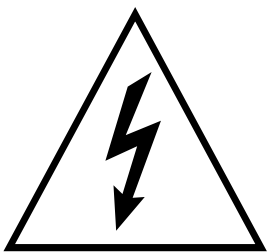

Dieses Symbol verweist auf nicht-isolierte Stromspannungen im Geräte-Innern, welche zu einem elektrischen Schlag führen könnten.

1. Xtreme Lead soll sauber und staubfrei gehalten werden. Das Gerät mit einem sauberen und säurefreien Tuch periodisch abreiben. Keine Lösungs- oder Reinigungsmittel anwenden.
2. Schmierer und Justieren sind nicht notwendig.
3. Bei weiteren Servicefragen wende man sich an eine qualifizierte Service-stelle.

Diese Gebrauchsanweisungen sind nur für qualifizierte Techniker beabsichtigt. Um die Gefahr eines elektrischen Schlages zu vermeiden, sollen Sie keine Arbeit unternehmen, die nicht in diesen Instruktionen vorgeschrieben ist. Wenden Sie Sich bei weiteren Servicefragen an eine qualifizierte Servicestelle.

### **INSTRUKTIONEN BETR. FEUERRISIKO, ELEKTROSCHOCK ODER VERLETZUNG VON PERSONEN**

**WARNUNG; Beim Einsatz elektrischer Geräte sollten folgende Vorsichtsmassregeln stets beachtet werden:**

1. Lesen Sie vor dem Einschalten des Xtreme Lead alle Instruktionen.
2. Zur Vermeidung von Verletzungsrisiken müssen Kinder bei eingeschaltetem Xtreme Lead sorgfältig überwacht werden.
3. Xtreme Lead nicht in der Nähe von Wasser in Betrieb nehmen -- z.B. in der Nähe von Badewannen, Waschschüsseln, auf nassen Gestellen oder am Swimmingpool.
4. Xtreme Lead stets so aufstellen, dass seine Belüftung nicht beeinträchtigt wird.
5. Xtreme Lead nicht in der Nähe von Hitze aufstellen, wie Heizkörper, offenem Feuer, Öfen oder von Backöfen.
6. Xtreme Lead ausschliesslich mit einem Netzgerät gemäss Bedienungsanleitung und Gerätemarkierung verwenden.
7. Dieses Gerät kann bei Verwendung von Kopfhörern und Verstärkern hohe Lautpegel erzeugen, welche zu bleibenden Gehörschäden führen. Arbeiten Sie nicht während längerer Zeit mit voller Lautstärke oder hohem Lautpegel. Stellen Sie Hörverlust oder Ohrenläuten fest, wenden Sie sich an einen Ohrenarzt.
8. Xtreme Lead kann mit einem polarisierten Kabelstecker (mit ungleichen Stiften) ausgerüstet sein. Das geschieht für Ihre Sicherheit. Können Sie den Stecker nicht in die Steckdose einführen, ändern Sie nicht den Stecker ab, sondern wenden Sie sich an einen Elektriker.
9. Das Netzkabel des Xtreme Lead bei längerem Nichtgebrauch aus der Steckdose ziehen.

10. Vermeiden Sie sorgfältig das Eindringen von Gegenständen oder Flüssigkeiten durch die Gehäuseöffnungen.
11. Das Gerät soll durch qualifizierte Serviceleute gewartet werden, falls:
  - A. das Netzkabel beschädigt wurde, oder
  - B. Gegenstände oder Flüssigkeit in das Gerät gelangten,
  - C. das Gerät Regen ausgesetzt war, oder
  - D. das Gerät nicht normal oder einwandfrei arbeitet, oder
  - E. das Gerät stürzte oder sein Gehäuse beschädigt wurde.
12. Servicearbeiten sollten nur qualifizierten Fachleuten anvertraut werden.

**DIESE INSTRUKTIONEN AUFBEWAHREN**



## ***Foreign Language Warnings*** **- French**

### **Instructions de Sécurité Importantes**

Une utilisation dans des pays autres que les U.S.A. peut nécessiter l'usage d'un cordon d'alimentation différent. Afin de réduire les risques d'incendie ou d'électrocution, référez-vous à un personnel de service qualifié, et n'exposez pas cet appareil à la pluie ou à l'humidité.

### **Instructions de Mise à la Terre**

Cet appareil doit être relié à la terre. Dans le cas d'une malfonction éventuelle, la terre fournit un passage de moindre résistance pour le courant électrique, réduisant ainsi les risques d'électrocution. Le Xtreme Lead est équipé d'un cordon muni d'un conducteur et d'une fiche devant être branchée dans une prise appropriée et reliée à la terre en conformité avec les normes locales.

### **Danger**

Une connexion incorrecte peut résulter en des risques d'électrocution. Vérifiez avec un technicien qualifié si vous avez des doutes quant à la connexion. Ne modifiez pas vous-même le cordon d'alimentation livré avec cet appareil; s'il ne rentre pas dans la prise, faites-en installer un autre par un technicien qualifié.

### **Attention**

Si le Xtreme Lead (Model 9110) est installé dans un rack, utilisez un rack standard ouvert de 48.25cm.

### **Instructions de Maintenance**

1. le Xtreme Lead doit être maintenu propre et sans poussière. Nettoyez-le périodiquement à l'aide d'un chiffon propre et non-pelucheux. N'utilisez pas de solvants, ou d'autres produits de nettoyage.
2. Aucune lubrification et aucun réglage ne sont nécessaires de votre part.
3. Pour tout autre service, référez-vous à un personnel qualifié.

## Instructions Concernant les Risques d'Incendie, d'Électrocution, ou de Blessures Corporelles.

**ATTENTION:** Lorsque vous utilisez des appareils électriques, certaines précautions élémentaires doivent toujours être prises, incluant les suivantes:

Ces instructions de dépannage sont destinées uniquement aux personnes qualifiées. Afin d'éviter les risques d'électrocution, n'effectuez que les opérations décrites dans ce manuel, à moins que vous ne soyez qualifié pour cela. Faites effectuer toute réparation par une personne qualifiée.



Ce symbole vous alerte de la présence d'instructions importantes d'opération et de maintenance dans la notice accompagnant l'appareil.

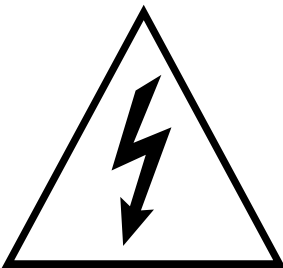

Ce symbole vous alerte de la présence d'un voltage non-isolé dangereux à l'intérieur de l'appareil, pouvant être d'une magnitude suffisante pour constituer un risque d'électrocution.

1. Lisez bien toutes les instructions avant d'utiliser le Xtreme Lead.
2. Afin de réduire les risques de blessures, une attention particulière est nécessaire en la présence d'enfants en bas âge.
3. N'utilisez pas le Xtreme Lead dans ou près d'endroits humides - par exemple près d'une baignoire, d'un lavabo, dans les toilettes, dans une cave humide, sur un bar fréquenté, en présence d'un bull-dog en rut, ou dans une piscine pleine. Protégez cet appareil de tout liquide, éclaboussure ou fuite.
4. Le Xtreme Lead doit être placé de façon à ce que sa position n'interfère pas avec sa propre ventilation.
5. Le Xtreme Lead doit être placé loin de sources de chaleur telles que des radiateurs, cheminées, fours, ou groupies en chaleur.
6. Le Xtreme Lead doit uniquement être connecté à une alimentation du type décrit dans les instructions d'opération et tel qu'indiqué sur l'appareil.
7. Une attention particulière doit être observée quant aux objets pouvant tomber et aux liquides pouvant être versés sur et à l'intérieur de le Xtreme Lead.
8. Le Xtreme Lead peut être équipé d'une fiche secteur polarisée (avec une broche plus large que l'autre). C'est une mesure de sécurité. Si vous ne pouvez pas brancher cette fiche dans une prise, ne neutralisez pas cette sécurité. Contactez plutôt un électricien pour remplacer la prise obsolète.
9. Evitez de marcher sur le cordon d'alimentation ou de le coincer, particulièrement près des prises de courant, des boîtiers électriques et du point de sortie de l'appareil.
10. Le cordon d'alimentation de le Xtreme Lead doit être débranché lorsque ce dernier n'est pas utilisé pendant une longue période.
11. Cet appareil, combiné avec un amplificateur, des haut-parleurs, et/ou un casque, est capable de générer des niveaux sonores pouvant occasionner une perte de l'ouïe permanente. Ne travaillez pas trop longtemps à un volume trop élevé ou même inconfortable. Si vous observez une perte de l'audition ou un bourdonnement dans les oreilles, consultez un O.R.L.
12. N'utilisez que les accessoires spécifiés par E-mu Systems.

## Interférences Radio et Télévision

13. Cet appareil doit être examiné par un personnel qualifié lorsque:
  - A. Le cordon d'alimentation a été endommagé, ou
  - B. Des objets sont tombés, ou du liquide a été versé sur/à l'intérieur de l'appareil, ou
  - C. Le Xtreme Lead a été exposé à la pluie, ou
  - D. Le Xtreme Lead est tombé, ou
  - E. Le Xtreme Lead ne fonctionne pas normalement, ou affiche un changement radical de performance.
14. Tout service doit être effectué par un personnel qualifié.

### **SAUVEGARDEZ CES INSTRUCTIONS**

L'appareil décrit dans cette notice génère et utilise une énergie de fréquence-radio. S'il n'est pas installé et utilisé correctement - c'est à dire en suivant strictement nos instructions - il peut occasionner des interférences avec la réception d'une radio ou d'une télévision.

Cet appareil a été testé et est conforme aux normes de Classe A en accord avec les spécifications du paragraphe J de la section 15 des lois FCC. Ces lois sont désignées pour fournir une protection raisonnable contre de telles interférences dans une installation résidentielle. Toutefois, il n'est pas garanti qu'aucune interférence n'apparaisse dans des installations particulières, et plus spécialement lorsqu'une antenne de télévision en «oreilles de lapin» est utilisée.

Si le Xtreme Lead occasionne des interférences, vous pouvez essayer de les corriger en utilisant une ou plusieurs des mesures suivantes:

- Tournez l'antenne de la télé ou de la radio jusqu'à ce que les interférences disparaissent.
- Déplacez le Xtreme Lead d'un côté ou de l'autre de la télé ou de la radio.
- Eloignez le Xtreme Lead de la télé ou de la radio.
- Branchez le Xtreme Lead sur une prise différente que la télé ou la radio.
- Installez une antenne sur le toit munie d'une connexion coaxiale entre elle et le poste de télévision.

# Declaration of Conformity



**Manufacturer:**

E-MU/Ensoniq  
1600 Green Hills Road  
Scotts Valley, CA 95067-0015 USA

*We hereby declare that the equipment listed herein conforms to the harmonized standards of the following European Commission Directives: 89/336/EEC and 72/23/EEC.*

**Trade Name:** Audio Sampler/Emulator System

**Model Number:** Proteus 1000 CR

***Under 89/336/EEC as amended by 92/31/EEC, and 72/23/EEC***

In accordance with EN 55103-1:1996, Emission Environments E1, E2, E3

In accordance with EN 55103-2:1996, Immunity Environments E1, E2, E3

Test information is contained in a report by Atlas Compliance and Engineering dated November 15, 1999.

Report No.: 9949EMU2KCR103

***Under 73/23/EEC as amended by 93/68/EEC***

In accordance with EN 60950 with amendments A1, A2, A3, A4, A11

***This Declaration is made November 15, 1999***

# *Setup*

## **Unpacking**

This section thoroughly describes how to set up your new Xtreme Lead-1 for use. Setup includes unpacking instructions and how to connect the cables.

Carefully remove Xtreme Lead-1 from the packaging material. Take care to save the packing materials in case you need to transport the unit. Check to make sure all components are included and in good condition. If there are missing or damaged components, contact E-MU Systems immediately for replacement or repair.

The Xtreme Lead box should include the following components:

- Xtreme Lead-1 rack unit
- Power cable
- Rack mounting ears
- This operation manual

# Connection Instructions

## Basic Setup

 If Xtreme Lead does not seem to be responding correctly, make sure that both Xtreme Lead and your MIDI controller are set to the same MIDI channel.

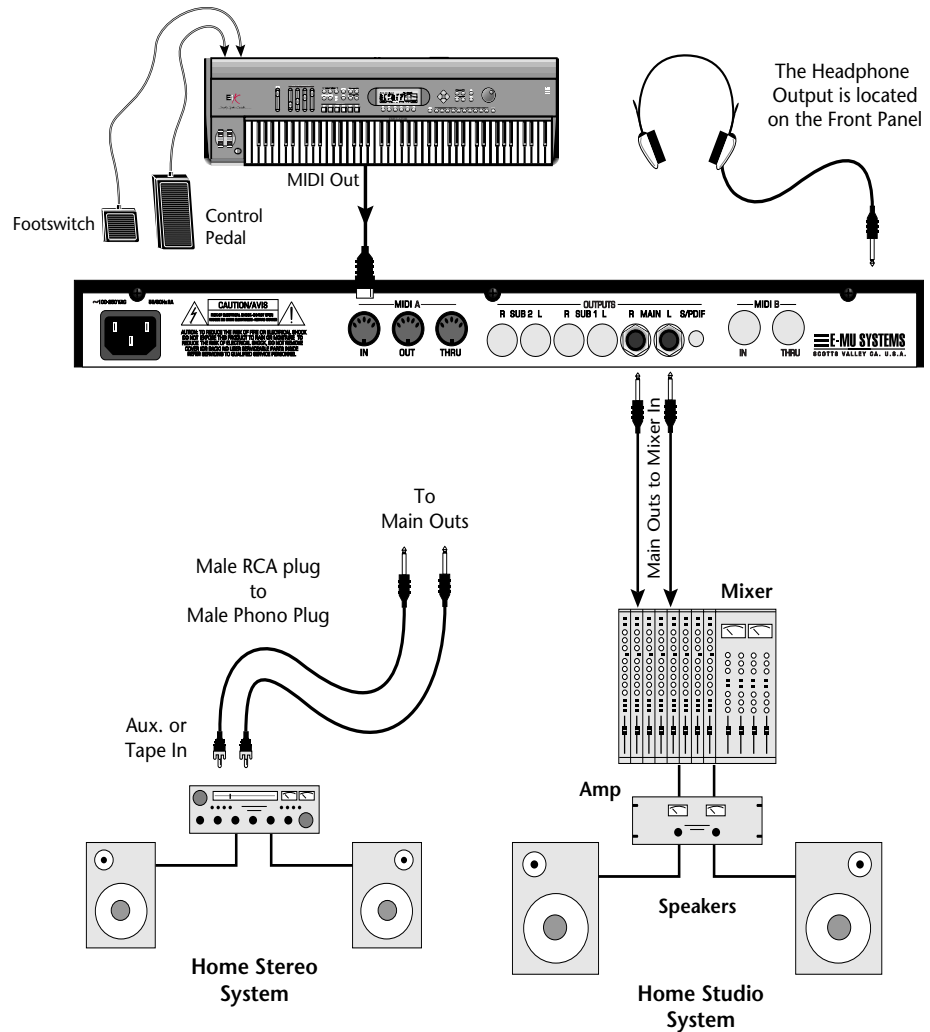

 The Right Main output jack serves as a mono output when the Left Main plug is not plugged in.

The Left Main output jack is a stereo jack carrying both channels when the right output jack is empty.

### MIDI In

XL-1 is controlled by MIDI messages received at the MIDI In jack. Normally you will connect MIDI Out of a controller such as a MIDI keyboard to the MIDI In jack of X-1. Be sure to connect a Footswitch and/or Control Pedal to your MIDI keyboard. Many of the factory presets use MIDI controllers.

### Outputs

In order to reproduce XL-1's wide dynamic range and frequency response, use a high quality amplification and speaker system such as a keyboard amplifier or home stereo system. A stereo setup is highly desirable because of the added realism of stereophonic sound. Headphones can be used if an amplifier and speaker system is not available. Plug stereo headphones into the headphone jack located on the left side of the front panel.

Studio Setup

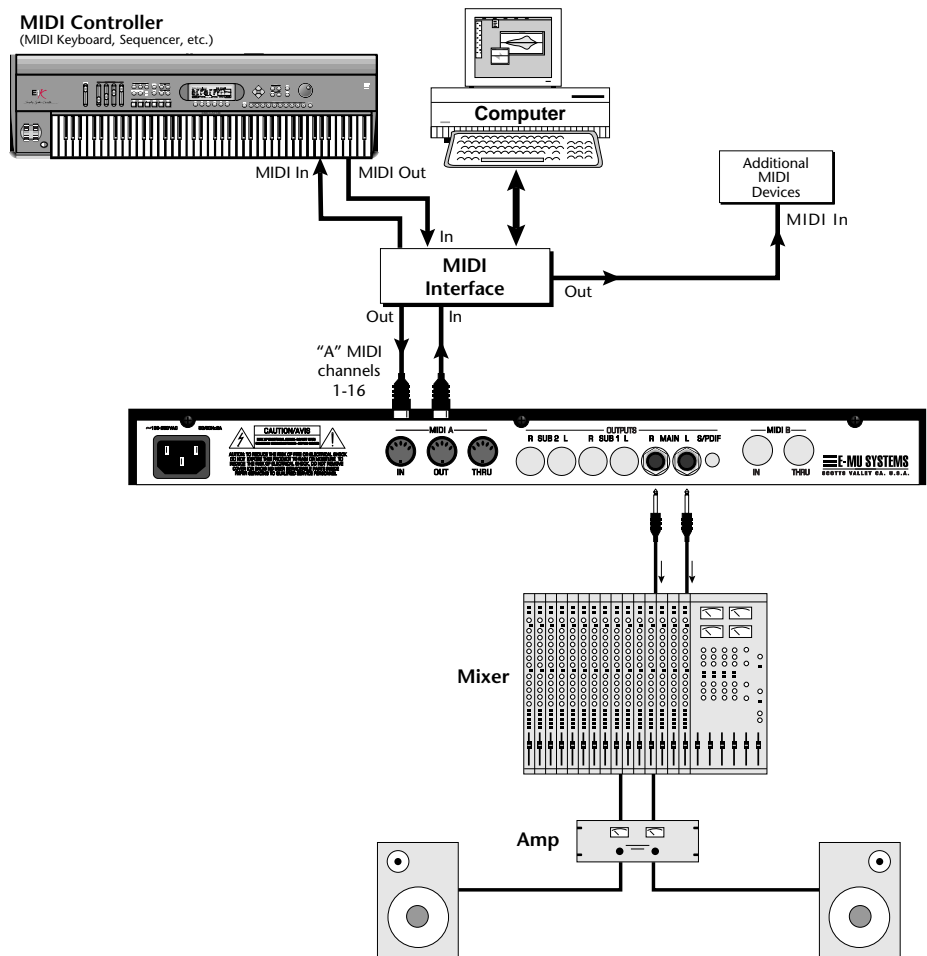

**MIDI In**

In this setup, Xtreme Lead is controlled by MIDI messages, received at the MIDI input, which are routed by the MIDI interface. The MIDI interface allows any MIDI controller, such as a MIDI keyboard or a computer, to control the module.

**MIDI Out**

The MIDI Out jack transmits program data to a computer or other device.

**Outputs**

A stereo connection is highly desirable because of the added realism of stereophonic sound. Plug stereo headphones into the headphone jack located on the left side of the front panel. The Right Main output jack serves as a mono output when the Left Main plug is not plugged in. The Left Main output jack is a stereo jack carrying both channels when the Right output jack is empty.

## *Power Up!*

The power switch is located on the right side of the front panel. You can turn on the XL-1 and its MIDI controller in any order. When power is applied the liquid crystal display will light, indicating that Xtreme Lead is operating. You may have noticed that there is no 110/220 Volt power selector switch on XL-1.

**Xtreme Lead automatically switches itself to the proper line voltage.**



## Instant Gratification

### *Playing Demo Sequences*

This section presents step-by-step instructions for the most fundamental operations to get you up and making sounds quickly.

Xtreme Lead has several factory demonstration sequences that let you hear what this incredible machine can do. The actual number of demo sequences depends on which ROM sounds sets are installed. You can play these demo sequences by accessing the Demo Sequence page.

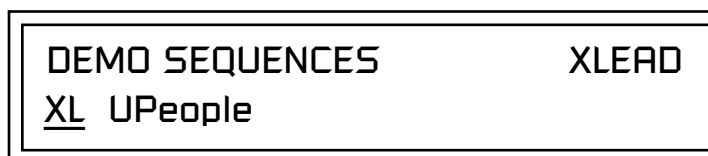

#### ► To Play a Demo Sequence

1. Press and hold the **Master** and **Edit** buttons at the same time to enter the Demo Sequence page. The screen shown above appears.
2. Select a sequence using the data entry control. The Enter LED will be flashing.
3. Press the Enter button to begin playing the selected sequence. The screen shown below appears.



4. Press the Enter button again to stop playing the sequence.
5. When a demo sequence plays to the end, the next demo will automatically begin playing. The screen will display the new demo name.
6. With the sequence stopped, press either the Master, Edit or Multi button to Exit the demo sequence mode.

### *Auditioning Presets*

The front panel audition button allows you to hear any preset in Xtreme Lead without even hooking up a MIDI keyboard! When the Audition button is pressed, the LED next to the button will illuminate and a short “Riff” (programmed as part of the preset) will play. The Riff is latched on and plays continuously until the button is pressed again. Presets can be changed while Audition is latched on.

The top line of the display changes to show the MIDI Bank Select controller values needed to select the preset being auditioned. This is an extremely handy feature when sequencing.

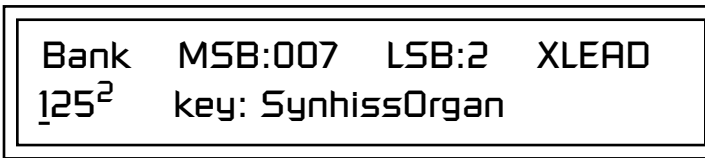

► **To Audition a Preset**

1. Select a preset by turning the data entry control while the cursor is anywhere on the lower line. The preset number field (shown above) is the normal position of the cursor and pressing the Enter button will return the cursor to this position.
2. Press the Audition button on the front panel. The Audition LED will illuminate and a short riff will play the selected preset.
3. Continue to select and audition presets.
4. Press the Audition button again to turn Audition mode off. The LED will extinguish.

*Selecting and Quick Editing Presets*

The first thing you'll do with the Xtreme Lead is select and play the factory provided presets. Xtreme Lead comes standard with 8 banks containing 128 presets each.

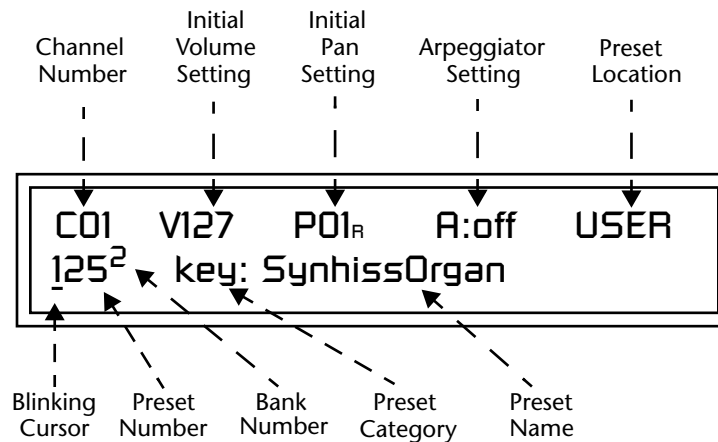

The first four banks are USER locations that can be overwritten and used to store your own presets. The presets that come stored in the USER presets are duplicated in banks 0-3 of the "Xtreme Lead" ROM bank, so feel free to overwrite them with your own presets. You won't be losing anything.

The *ROM Card* identifier is shown in the top right of the display. The preset is identified in the bottom line of the main screen (the screen that appears when you first power up the unit).

Each bank of 128 presets is identified by a superscripted *Bank Number* to the right of the preset number. The bank numbers reset to 0 at the start of each ROM card you have installed. So with the Xtreme Lead ROM installed, the USER banks will go from 0-3, then start over from 0-3 for the Xtreme Lead ROM banks.

To the right of the preset number and bank is the preset *Category* name followed by the *Preset Name*.

### ► To Change the Preset

1. Place the cursor under the first character in the Preset Number field. This is the “Home” position which is selected instantly when you press the Home/Enter button. Pressing either of the two cursor buttons repeatedly also gets you there.
2. Turn the Data Entry Control knob on the front panel to select a new preset number. If you turn the knob slowly, the presets advance one number for each “click” of the knob. If you spin the knob quickly, the numbers advance much faster (more than one number per click).
3. Play the keyboard (or press the Audition button) and listen to the sounds made by your Xtreme Lead!
4. **TURN THE FOUR KNOBS** on the front panel and note how they change the sound of each preset! Press the button to the left of the controller knobs to change the function of the knobs. Don’t worry about ruining the sound, the values are automatically reset as soon as you select a new preset.

 You can select presets from the Preset Number, Bank Number, Preset Category or Preset Name fields.

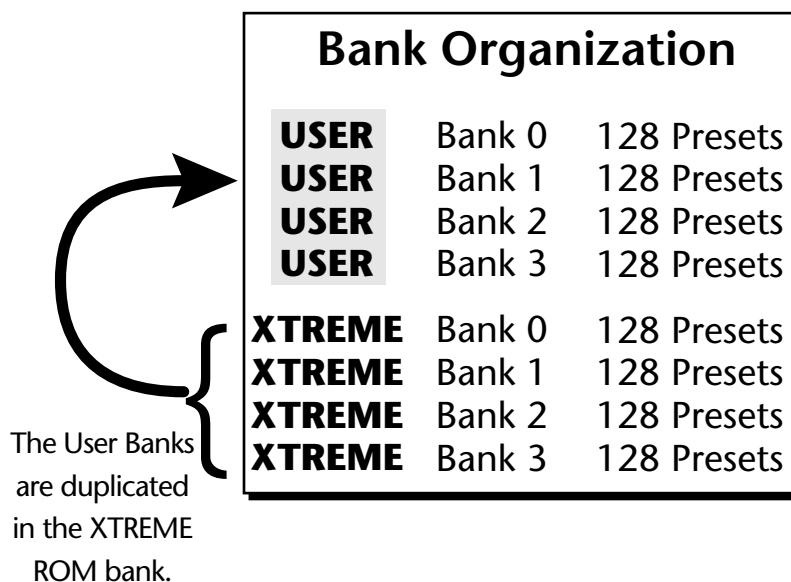

The four User Banks can hold 512 custom presets. Feel free to overwrite these since the factory user presets are duplicated in nonvolatile ROM.

## Playing BEATS



If you don't select a "bts:" preset, only the first trigger key will work.

Riffs marked "BTS" have 16 tracks. Riffs without "BTS" have only 1 track.

This function controls the BEATS for the currently selected MIDI channel (the default channel is 1). Unlike the Arpeggiators, BEATS is only active on one MIDI channel at a time.

### ► To Play BEATS (Quick Start)

1. Select any preset with the **bts:** prefix.
2. Play the keyboard keys in the range shown in the default template below. Be sure to try out each key.

### Default Assignment of BEATS

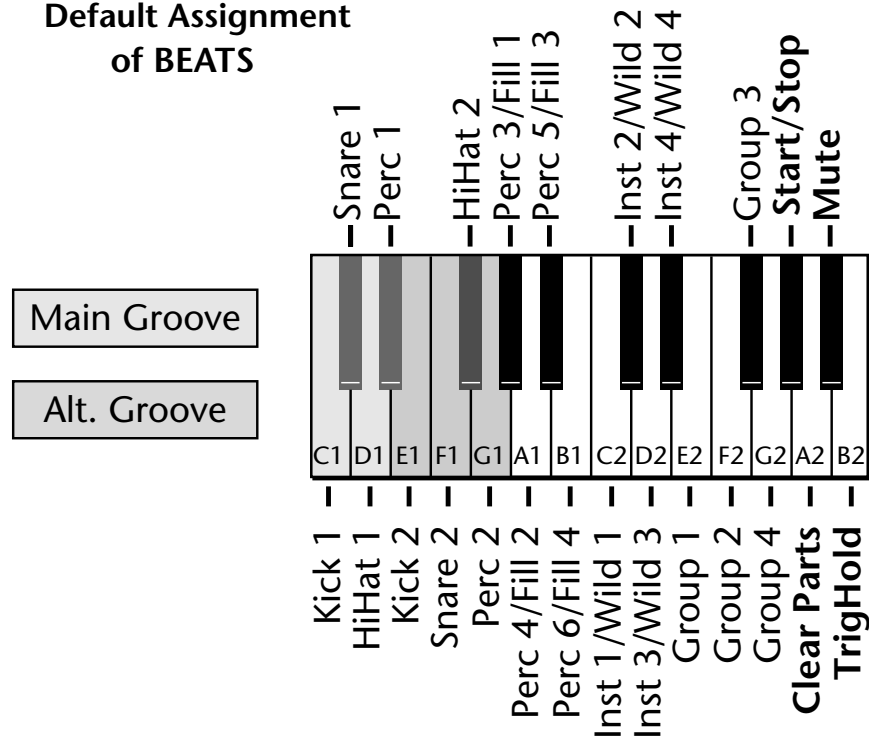

3. Now try out the "Wild 1-4" knobs and other "bts:" presets.
- **If BEATS are not playing:** Go into the Arp/Beats menu, locate the screen shown below and set the parameters exactly as shown.

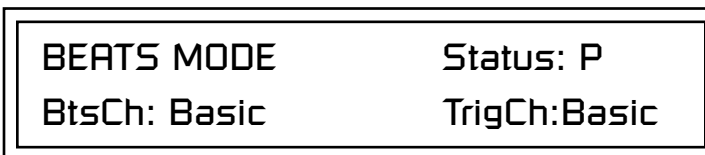

► **To Latch BEATS Triggers**

The Trigger Keys can be *Latched* so that pressing once turns a key on and pressing the key again turns it off.

1. Press the Arp/Beats button and turn the Data Entry control until the following screen appears (this is the 3rd screen from the beginning).

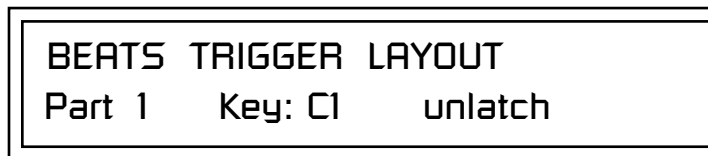

2. Press either cursor button repeatedly until it is underneath the Part field.
3. Rotate the Data Entry Control to select the desired part.
4. Press either cursor button repeatedly until it is underneath the unlatch/latch field.
5. Rotate the Data Entry Control to change the status to "Latch".
6. Repeat steps 2-5 until Parts 1-16 are latched.
7. Now play the Trigger Keys and hear the results.
8. Press the **Clear** Trigger Key to kill all latched Parts.
9. Start up a few more triggers and play with the **Mute** key.

► **To play BEATS on a different MIDI channel**

You can have your cake and eat it too.

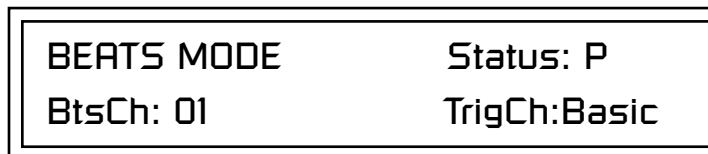

1. Press the Arp/Beats button and locate the screen shown above (the 2nd screen from the beginning).
1. Set your MIDI keyboard to transmit on channel 2.
2. Select any "bts:" preset on channel 1 (*main screen*).
3. From the main screen, change to channel 2 and select another preset.
4. The Trigger Keys now play BEATS and the other keys play the preset on channel 2

**Want more?**

5. On channel 2, select a preset with the **arp:** prefix.
6. Set the arpeggiator to **P** (A:P) on the main screen (channel 2).
7. Now you can play BEATS *and* arpeggiate. Yeow!

## Exploring the Master Arpeggiator

Xtreme Lead's multi-channel Pattern Generator/Arpeggiator is one of the greatest features ever put in a synth. Let's explore the Master Arpeggiator.

### ► To Arpeggiate a Single Preset:

1. Select a preset. Note that the factory presets all have prefixes which describe the type of sound. For this investigation it might be best to choose a preset with the prefix "arp," for arpeggiator. These presets are optimized for use with the arpeggiator.
2. Set the Arp parameter in the main screen to "M" for Master Arpeggiator.

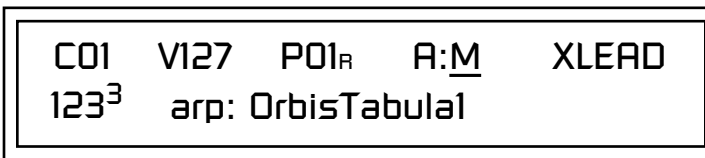

3. Press the Arp/Beats menu button on the front panel to access the master Arpeggiator menu, then use the Data Entry Control to scroll to the screen shown below.



4. Make sure the arpeggiator Status is "on." Play the keyboard to start arpeggiating.
5. Press either cursor key repeatedly to move the cursor below the Status field.
6. Turn the Data Entry Control clockwise one click. The Mode screen appears.

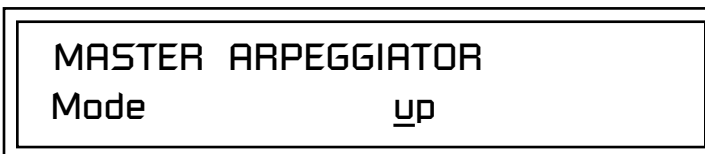

7. Use the cursor keys to move the cursor to the Mode field (up, down, up/down, forw asgn, backw asgn, forw/backw, random, pattern). Try out the different modes as you play the keyboard.
8. Move the cursor back to the lower left position and explore the other parameters. The Note Value parameter changes the rate of the arpeggios. By the way, note value is a divisor based on the Master Tempo (which has its own front panel button). Try changing the tempo, but come right back.

 Try using the control knobs to change the arpeggiator parameters.

9. Let's check out the pattern generator. Go back to the Mode screen and set the mode to "Pattern".
10. Now advance to the Pattern screen (shown below) and move the cursor to the Pattern Number field (the second field from the left).



 See the *Arpeggiator Chapter* for detailed information on creating Patterns.

11. Try the various patterns. There are 200 permanent factory patterns and 100 user locations to store the patterns you create. Each pattern can have up to 32 notes.

## Multi-Channel Arpeggiator

Xtreme Lead is totally unique in its ability to run up to 16 arpeggiators at once! Even two or three patterns at once can create very complex sequences and dynamic landscapes of sound.

Here's one way to access this ultra-powerful feature. There is one arpeggiator for each MIDI channel. In order to arpeggiate on multiple channels, you'll need a controller that can output multiple MIDI channels at once.

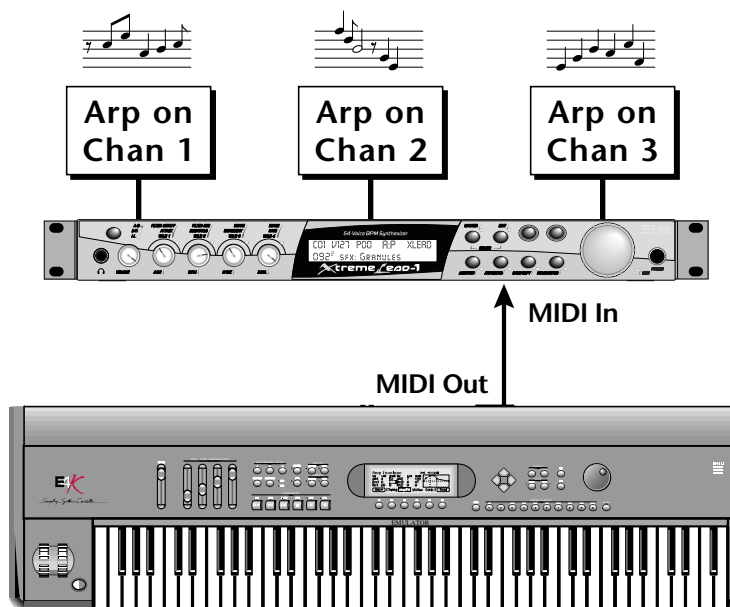

**Master Keyboard transmitting on MIDI channels 1, 2, 3**

Connect a multi-channel controller to XL-1 to unleash its true potential!

1. Set up your MIDI keyboard so that it outputs the entire keyboard range on MIDI channels 1, 2, and 3. This procedure varies with the type of keyboard you own.
2. Put Xtreme Lead into Multi mode. This is located on the MIDI Mode page in the Master menu.
3. From the main screen, turn the arpeggiator “on” for MIDI channels 1 and 2. (We’re only using two for now to keep it simple.) Select a different preset for each MIDI channel while you’re at it.

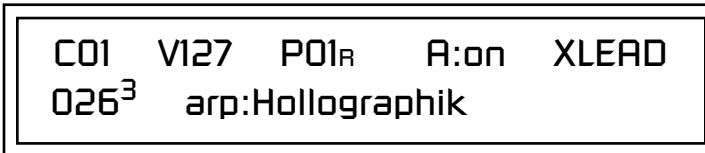

4. Start playing. You should be hearing two arpeggiators playing at once.
5. Change presets on one or both of the MIDI channels you are using (1 & 2). Since each factory preset has differently programmed arpeggiator settings, changing the preset not only changes the sound, but the arpeggiator as well.
6. Press the Control Select button on the front panel so that the “Arp/Beats” LED is illuminated. Adjust the front panel control knobs. Remember that the knobs are controlling the arpeggiator on the channel displayed in the main screen.
7. Try changing one of the channel’s arpeggiator setting to “M” instead of “on.” Now press the Arpeggiator menu button on the front panel and adjust the arpeggiator parameters in real-time.
8. From the Master Arpeggiator menu, set the Mode to “Pattern” then explore the different patterns. There are 200 patterns available!

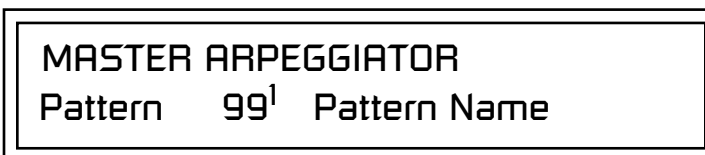

 Don't forget that you can adjust the volume and pan position for each channel. Sometimes a simple volume change will bring out hidden rhythms and patterns.

You're starting to get the picture of how versatile and easy to use this machine really is.



# Basic Operations

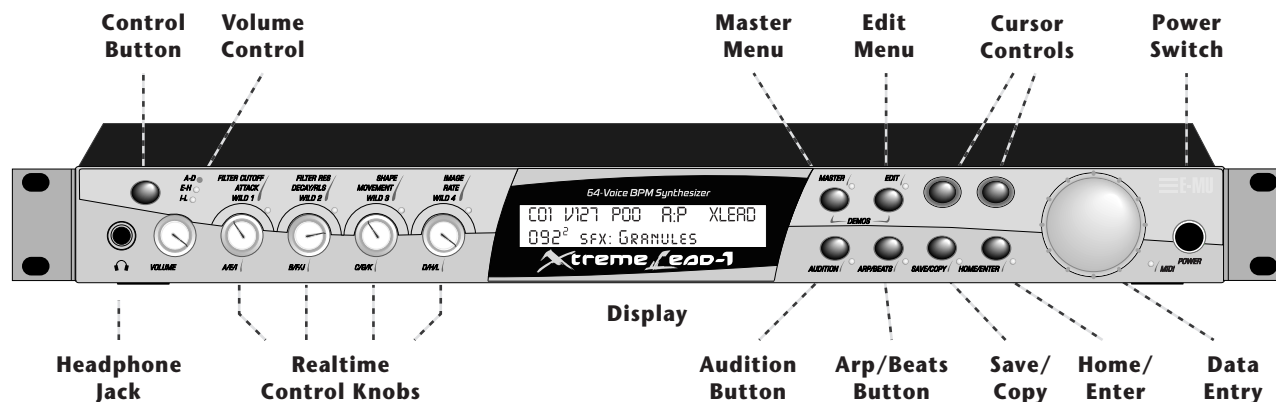

## Front Panel

The Xtreme Lead front panel contains an LCD screen, nine buttons and four real-time controllers. Functions are grouped logically and the controls are arranged for ease of use. Precisely because Xtreme Lead is so simple to use, you might be tempted to skip this section. If you just can't help yourself, at least read the Real-time Controller information beginning page 35. There are several "power user" features in the interface which make programming even easier and we wouldn't want you to miss them.

### Volume Control

This control is the master volume control for all audio outputs. The Volume Control does not affect any editing or user interface operations. For maximum dynamic range, turn this knob all the way up and control the volume from your mixer or amplifier.

### Master Button

The Master menu contains parameters that affect the entire machine, not just certain presets. An illuminated LED to the right of the button indicates that you are in the Master menu.

### Edit Button

Use the Edit menu when you want to create or modify a preset. An illuminated LED to the right of the button indicates that you are in the Edit menu.

### Control Button

The Control button is used to change the function of the Controller knobs (see the next section). Each time you press the Control button, the Control Mode toggles to select only one of the three Control Rows. The currently selected Control Row is indicated by one of the three LEDs to the right of the row's label.

## Audition Button



### L.E.D. Beat Markers

- The Audition LED flashes off quickly on each downbeat and flashes off for a longer period on the Riff Loop.
- The Clock LED flashes to mark each quarter note.

The Audition button allows you to hear any preset without hooking up a MIDI keyboard. When the Audition button is pressed, the LED next to the button will illuminate and a short “Riff” (programmed as part of the preset) will play. The Riff is latched on and plays continuously until the button is pressed again. Presets can be changed while Audition is latched on. See “Bank Select Commands” on page 118 for more information on selecting banks via MIDI.

The top line of the display changes to show the MIDI Bank Select controller values needed to select the preset being auditioned. This handy feature lets you know the exact Bank and Preset number to enter into your sequencer.

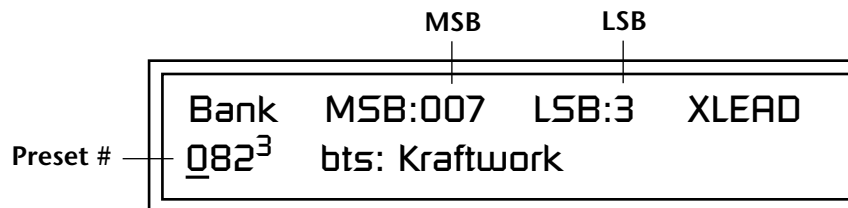

## Left/Right Cursor Buttons

These buttons move the cursor to the next parameter on the display. (The cursor is a little flashing line underneath one of the parameters in the display.) Press either cursor button until the cursor is underneath the desired parameter. The cursor buttons have an auto-repeat feature which advances the cursor when the button is held continuously.

The cursor can be moved bidirectionally using the Data Entry Control while either cursor select button is held down (for example, press and hold the right cursor button and turn the Data Entry Control).

## Save/Copy Button

The Save/Copy button is used to save or copy presets and to copy data. Selected groups of parameters, such as PatchCord settings, can be copied between Presets and/or between Layers using this menu.

The LED to the right of the button illuminates to indicate that you are in the Save/Copy menu. The LED also illuminates when any preset parameter has been changed in the Edit menu (or if the front panel knobs have been moved with Quick-Edit mode enabled).

## Home/Enter Button

The Home/Enter button is dual purpose. In general, this button acts as the “Home” button. For example, when in an Edit menu, this button snaps the cursor to the page name field of the current screen. When viewing the Preset Select screen (we also call it the main screen), this button snaps the cursor to the preset number field. In these instances, the LED is not used.

Some screens and parameter fields use this button as the “Enter” button. In these cases, the LED blinks to indicate that the module is waiting for your response to initiate the operation.

## Data Entry Control

The Data Entry Control is a stepped, variable control switch used to change parameter values. The wheel increments or decrements the current value one unit with each click. This control incorporates acceleration, which advances the value faster if the Data Entry Control is turned quickly.

# Front Panel Controller Modes

The Real-time Controller Knobs serve three purposes:

1. Real-time control of synthesizer parameters
2. “Quick Editing” the initial settings of the real-time controllers
3. “Deep Editing” the parameters

This section describes each of the three uses.

## Real-time Control

The Real-time controller knobs provide direct control of the Xtreme Lead’s synthesizer parameters. They are always active when on the Preset Select (main) screen. They can optionally be used to transmit MIDI controller messages to other MIDI devices.

The Control button (left of the knobs) changes the function of the real-time controller knobs. Each time the button is pressed, the Control Mode toggles to select one of the three Control Row groups. The currently selected Control Row is indicated by the illuminated LED to the right of the button. The control knob functions are determined by the selected Control Row.

The three Control Rows generate MIDI data that can control the preset on the current MIDI channel (the channel showing on the Preset and main screen. The labels (Filter Cutoff, Filter Res, Shape, Image, etc.) printed on these rows show how the factory ROM presets may be programmed to respond. *(The controls might not conform to the front panel labels depending on the preset.)* You can change the way a preset responds to MIDI A-L messages from the Edit menu (PatchCords).

There is an LED next to each of the control knobs which illuminates to indicate that the knob setting has been changed from the value programmed in the preset (when Quick Edit mode is enabled). If the knob position is returned to the original setting, the LED is extinguished.

If the “Knobs MIDI Out” parameter in the Master menu (see “Knobs/Riff MIDI Out” on page 86) is set to “transmit,” the system sends a MIDI controller message when you turn off the Control knob. The MIDI controller message is sent on the current MIDI channel (also called the basic channel) using the controller number assigned in the Master menu (see “Real-time Controller Assignment” on page 83).

The knobs only generate a message when you move a knob to a new value. The current value jumps to the new value.

## Quick Edit



Quick-Edit mode must be enabled in the Master menu.

This mode uses the Controller knobs to “Quick-Edit” the currently selected preset without having to enter the Preset Edit menu. This mode is only active when on the Preset Select screen and when “Quick-Edit” is enabled in the Master menu (see “Knob Preset Quick-Edit” on page 85).

Initial controller values can be stored in every preset. When you move a knob with Quick-Edit enabled, the Initial Controller Value is updated with the knob’s new value. The knob’s LED lights indicating that the preset value has been changed. The three Control Rows’ MIDI A-L values are stored in the corresponding *Initial Controller Amount* parameter in the Edit menu (see “Initial Controller Amount” on page 160). The Save/Copy button LED illuminates to remind you that the preset has been edited. “Quick-Edits” made to a preset are lost if you select another preset before saving them.

### ► To Quick-Edit a Preset

1. Use the Control Knobs to change the sound of the current preset as desired.
2. Press the Save/Copy button. The display reads, “Save Preset to.”
3. Press the right cursor button to select the bottom row.
4. **Optional:** Select a new preset location if you don’t want to overwrite the current preset, or if the current preset is a ROM preset.
5. Press the Enter button to save the preset.

## Deep Edit Mode

When in the Master, or Edit menus, you can use the Controller Knobs to edit parameters. Using the Controller Knobs is a faster method for entering data, but the Data Entry Control offers finer precision.

### ► To Enable Deep Edit Mode:

1. Press the Master button and use the Data Entry Control to advance to the “Knobs Deep Edit” screen as shown in the following illustration.



2. Press either Cursor key to move the cursor to the bottom line in the display.
3. Use the Data Entry Control to change the value to “enabled.”
4. Press the Master menu button to exit the Master menu.

### When you enter any of the Edit menus:

1. The four Controller Knobs are used for editing.
2. All the Controller LEDs are off.
3. All the Control Row LEDs are off.

When you turn a knob, the field value jumps to the current knob value. You can still use the Data Entry Control for editing by moving the cursor to the desired field.

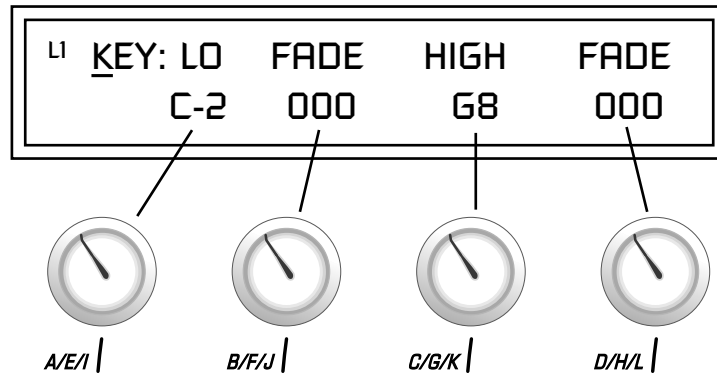

To move through menus horizontally, use the Data Entry Control (the page's title field is the default cursor position). To move through menus vertically (preset layers), press the left cursor to get to the layer field, then change layers with the Data Entry Control.

- Use the Data Entry Control to move through menus (horizontally) or layers (vertically).
- Use the Controller Knobs to change parameter values within each page.

## Main Screen

The Preset Select screen is Xtreme Lead's default screen (also called the main screen) and is active when you have not selected any of the other button-activated menus. From this screen you can change or examine the Preset, Volume, Pan Position and Preset Location for each of the 16 MIDI channels.

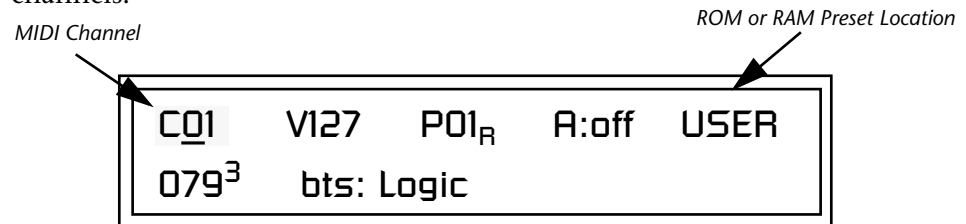

### MIDI Channel Selection

 The channel number shown in the main screen is the "basic MIDI channel" when in Omni or Poly modes.

#### ► To Change the MIDI Channel

1. Press either cursor button until the cursor is underneath the channel number. (The cursor is the little flashing line underneath one of the parameters in the display.)
2. Rotate the Data Entry Control to select a MIDI channel (01-16). As the channel number changes, the display changes to show the preset, volume, pan and preset location associated with the displayed channel.

### Preset Selection

#### ► To Change the Preset

1. Press either cursor key until the cursor is underneath the preset number. (The cursor is a little flashing line underneath one of the parameters in the display.) As you rotate the Data Entry Control, the preset number and name changes.
2. The displayed preset is assigned to the displayed MIDI channel. Presets are arranged into banks of 128, as shown in the diagram at left.

Bank	Contents
0	– 128 RAM Presets
1	– 128 RAM Presets
2	– 128 RAM Presets
3	– 128 RAM Presets
ROM 1	0 – 128 ROM Presets
	1 – 128 ROM Presets
	2 – 128 ROM Presets
	⋮
	⋮
	?? Depending on ROM sets installed

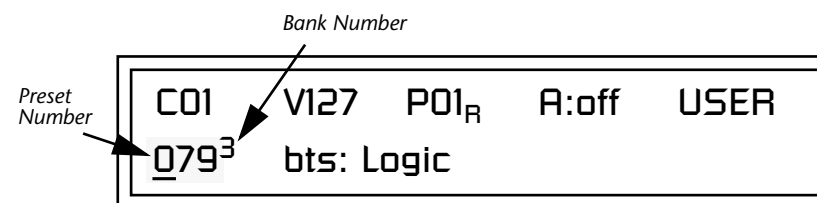

Using the screen above as an example, the superscripted number 2 in the second line of the display identifies the current bank number.

- Select banks independently of the of the preset number by locating the cursor on the Bank field and turning the Data Entry Control.

<b>MIDI BANK SELECT</b>			
	<b>MSB</b>	<b>LSB</b>	
	<b>cc00</b>	<b>cc32</b>	
<b>USER</b>	00	00	Bank 0
<b>USER</b>	00	01	Bank 1
<b>USER</b>	00	02	Bank 2
<b>USER</b>	00	03	Bank 3
<b>XTREME</b>	07	00	Bank 0
<b>XTREME</b>	07	01	Bank 1
<b>XTREME</b>	07	02	Bank 2
<b>XTREME</b>	07	03	Bank 3

This chart shows the MSB and LSB numbers needed to select preset banks over MIDI. Select a bank, then send the program change number. Without a bank select command, presets are selected from within the current bank.

## Channel Volume

Channel Volume sets the volume of the selected MIDI channel in relation to the other channels. This is the same parameter as MIDI volume control #7, and changes made over MIDI are shown in the display.

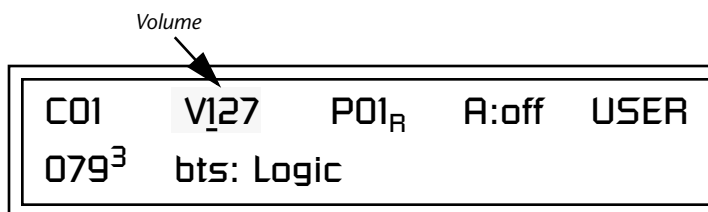

### ► To Change the Channel Volume

1. Press either cursor key until the cursor is underneath the volume value.
2. Rotate the Data Entry Control to select a volume level. The Channel Volume range is 000-127.

## Channel Pan

Channel Pan sets the stereo position of the selected MIDI channel. This control operates like the balance control on your home stereo system. Channel Pan is the same parameter as MIDI pan controller #10, and changes made over MIDI are shown in the display.

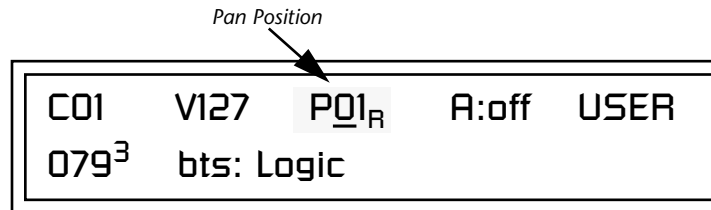

**Note:** Pan settings in the preset ADD algebraically with the Channel Pan setting. Therefore, if the pan setting in the preset were set to “63R,” moving the Channel Pan setting full left would return the sound to the center position.

### ► To Change the Channel Pan

1. Press either cursor key until the cursor is underneath the pan field.
2. Rotate the Data Entry Control to select a pan value. 64L indicates a hard left pan, 63R indicates a hard right pan. With a setting of “00,” the sound is centered in the stereo field.

## Channel Arpeggiator

This function controls the arpeggiator for each MIDI channel. When the channel arpeggiator mode is set to Off, then there is no arpeggiation on that channel, regardless of what is set up in the Master Arpeggiator or preset. If the channel arpeggiator is On, the preset’s arpeggiator is used, regardless of whether or not it is turned on in the Edit menu. This lets you turn on arpeggiation from the main screen.

If the mode is set to “P” (for preset), the preset’s arpeggiator settings and on/off status is used. If the mode is set to “M” (for master), the master arpeggiator settings and on/off status (located in the Arp/Beats menu) are used. *See the “Arpeggiator/Beats Menu” on page 43 for more information.*

### ► To Play the Arpeggiator (Quick Start)

1. From the main screen, press either cursor key repeatedly until the cursor is underneath the arpeggiator field (A:).
2. Rotate the Data Entry Control to select “P” for preset.
3. Press either cursor key repeatedly until the cursor is underneath the Preset Category field and select “arp:” using the data entry control.
4. Press the right cursor button to move it to the Preset Name field.
5. Play notes or chords on the keyboard. Change presets as desired to audition the various patterns and presets.



# Sound Navigator

## Preset Category

Sound Navigator allows you to search through preset and instrument categories to find the type of sound you're looking for. Each preset and instrument has a name and a three letter preset category. You can create your own categories in order to group favorite presets. The preset category is assigned in the Edit menu (Preset Name). Instrument categories are fixed.

When you want to find presets in a particular category, you simply change the category field in the main screen, then move the cursor to the preset name field to scroll through all the presets in the selected category.

When the cursor is on the Preset Category field, turning the Data Entry Control selects different preset categories. The Name Field will change to show the first preset in each category.

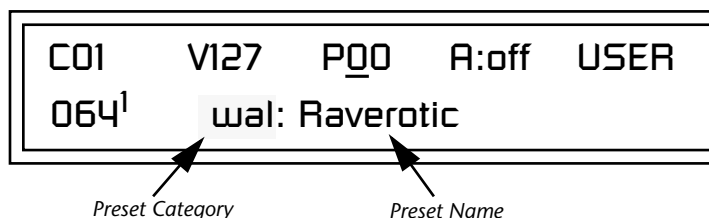

### ► To Change the Preset Category

1. Press either cursor key repeatedly until the cursor is underneath the preset category field.
2. Rotate the Data Entry Control to select one of the preset categories. Preset Categories are displayed in alphabetical order.

### ► To Select a Preset within a Category

1. After selecting a category, move the cursor to the Preset Name field.
2. Rotate the Data Entry Control to scroll through the presets in the selected category. Note that the preset numbers will no longer change sequentially.

## Instrument Category

When the cursor is on the Instrument Category field (Edit menu), turning the Data Entry Control selects different instrument categories. The Name Field changes to show the first instrument in each category. Move the cursor back to the instrument number to select instruments in the selected category.



# Multitimbral Operation

 Save the Multisetup using the instructions provided in Chapter 3: Multisetup.

Multitimbral operation means that Xtreme Lead can play more than one sound at the same time. Follow these instructions to access multiple presets on different MIDI channels simultaneously.

## ► To Set Up Xtreme Lead for Multitimbral Operation

1. Set the MIDI mode to “multi mode,” using the MIDI mode function in the Master menu.
2. Decide which MIDI channels you want the Xtreme Lead to receive (16 channels can be used simultaneously). You can turn any unused channels OFF using the MIDI Enable function in the Master menu.
3. Select the desired preset for each of the MIDI channels you want the Xtreme Lead to receive using the MIDI Channel/Preset selection screen (see previous instructions).
4. Xtreme Lead now responds multitimbrally on each of the MIDI channels you have specified. The volume and pan position parameters can be adjusted over MIDI (for each MIDI channel) or using the Cursor and Data Entry Control in the Preset Select screen.

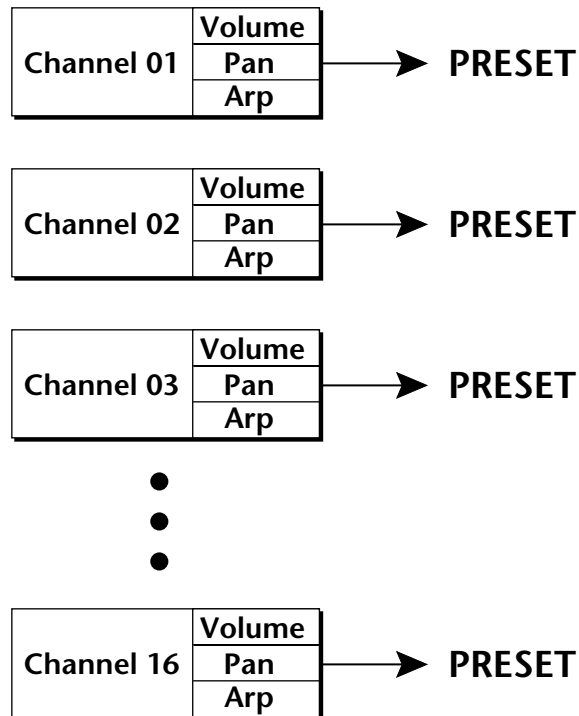

Each of the 16 MIDI channels can be assigned to play a specific Xtreme Lead preset.

# Arpeggiator/Beats Menu

Xtreme Lead's SuperBEATS mode allows you to trigger, latch and unlatch synced loops and grooves from separate keys on your keyboard. Select a SuperBEATS Riff and then choose any one of Xtreme's 1024 presets. Now by playing 24 assignable keyboard keys, you can bring specific *Parts* in and out. This is *Macro-Music!*

XL-1 can also run up to 16 simultaneously synced arpeggiators, each with a different preset sound. The arpeggiators can either play one of 7 arpeggios or can be set to play a pattern, which is a stored sequence of notes. Combined with SuperBEATS, the number of musical permutations is staggering!

## ► To enable the Arpeggiator/Beats menu

Press the Arp/Beats button, lighting the LED. The Arp/Beats screen displays the menu page most recently selected since powering up Xtreme Lead. The cursor appears below the first character of the screen heading on line one.

## ► To select a new screen

Press the Home/Enter button or press the Cursor button repeatedly until the cursor is below the screen title heading on the top line of the display. Rotate the Data Entry Control to select another screen.

## ► To modify a parameter

Press either Cursor button repeatedly (or hold down the right cursor button while turning the Data Entry Control) until the cursor is below the desired parameter value. Rotate the Data Entry Control to change the value.

## ► To access a submenu

The Beats Trigger Layout and the Master Arpeggiator screens have submenus which are accessed by pressing the cursor buttons to move the cursor to the lower left corner of the display. Select the submenu function using the Data Entry Control.

## ► To save Arpeggiator/BEATS parameters

Press the Save/Copy button and scroll to "Save Setup". Select a Setup number and press Enter. See "*Saving Multisetups*" on page 197.

## ► To return to the main screen

Press the Arp/Beats button, turning off the LED.



*Arp/Beats and Master parameters are automatically saved to the current multisetup when you exit the menu, but you may wish to save to another location*

## Base Tempo



To control Riffs using MIDI clock, be sure to set Riff Tempo (page 54) to “use current tempo”.

Xtreme Lead contains an internal Master Clock. The Master Clock controls SuperBEATS, arpeggiators, synchronizes the LFOs when in tempo-based mode, controls the times of tempo-based envelopes, and can be used as a modulation source in the PatchCords section. There are two tempo values shown in the display.

- **Base Tempo** - This is the base tempo setting before being modified by the Tempo Controller (if engaged). See “Tempo Controller” on page 85.
- **Current Tempo** - This is the actual tempo. The current tempo is equal to the base tempo modulated by the MIDI controller specified in the Tempo Controller screen. If no MIDI Tempo controller message has been received since the last Base Tempo change, the Current Tempo will be equal to the Base Tempo.

The LED to the right of the button blinks at the current tempo rate.

### ► To Change the Master Tempo

1. Move the cursor to the lower line of the display.
2. Adjust the Base Tempo using the Data Entry Control.

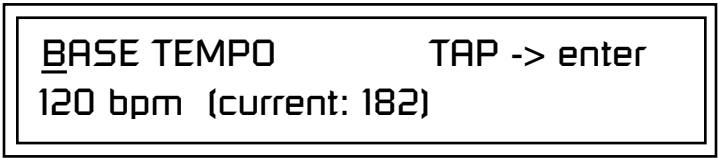

3. **To Tap Tempo** - Tap the Enter button at least three times when the cursor is on the top line of the display. Keep tapping to continuously update the tempo on each tap. The tap tempo range is 25-300 bpm.

The Base Tempo values range from 1 through 300 beats per minute (BPM) or you can select “use MIDI” to use an external MIDI clock source.

## SuperBEATS



### L.E.D. Beat Markers

- The Audition LED flashes off quickly on each downbeat and flashes off for a longer period on the Riff Loop.
- The Clock LED flashes to mark each quarter note.

SuperBEATS is a 16-track play-only sequencer that is optimized for live performance and groove creation. XL-1 contains dozens of special 16-part BEATS Riffs created by some of the best producers in the business. BEATS Riffs are normally used in conjunction with a “bts” preset containing the appropriate percussion mapping, but any preset can be selected and used.

The BEATS channel is selected from the Beats enable screen in the Arp/Beats menu.

Here’s how it works. Each of the 16 parts is assigned to a keyboard key on the selected Trigger MIDI channel. Each part is brought in or out by pressing that key. Keys can also be Latched (*press the key once to turn the part on, press it again to turn the part off*). Other control keys allow you to Mute All Parts, Clear All Parts, and Start & Stop the groove. The 16 parts are arranged in the following manner:



*BEATS (BTS) Riffs are special 16-part riffs made especially for use with BEATS mode. A Riff without the **BTS** prefix only has Part 1 recorded.*



*Trigger layouts are saved with the Multisetup. See "Trigger Layouts" on page 221 to examine several other factory BEATS trigger layouts.*

Main Groove	Alt. Groove	Perc / Fills	Instr/Wild
1. Kick1	5. Kick2	9. Perc3/Fill1	13. Inst1/Wild1
2. Snare1	6. Snare2	10. Perc4/Fill2	14. Inst2/Wild2
3. Hihat1	7. Hihat2	11. Perc5/Fill3	15. Inst3/Wild3
4. Perc1	8. Perc2	12. Perc6/Fill4	16. Inst4/Wild4

For each BEATS Riff, you have 2 Grooves, 4 Fills which correspond to the four parts of the Main and Alternate groove, and 4 Instrument parts. By adding and removing parts, you control the complexity of the groove.

Each part can also be scaled by *Key Velocity*, allowing you to fade parts in and out (if velocity is routed to volume) as you play, or can be *Transposed* over a six octave range.

Each part can be assigned to any one of four *Groups*, which allow multiple parts to be triggered from a single key.

The chart below shows the default assignment of each Part, the 4 Groups and the Control Keys (shown in **bold**). These assignments can be modified to suit your personal preference.

### Default Assignment of BEATS

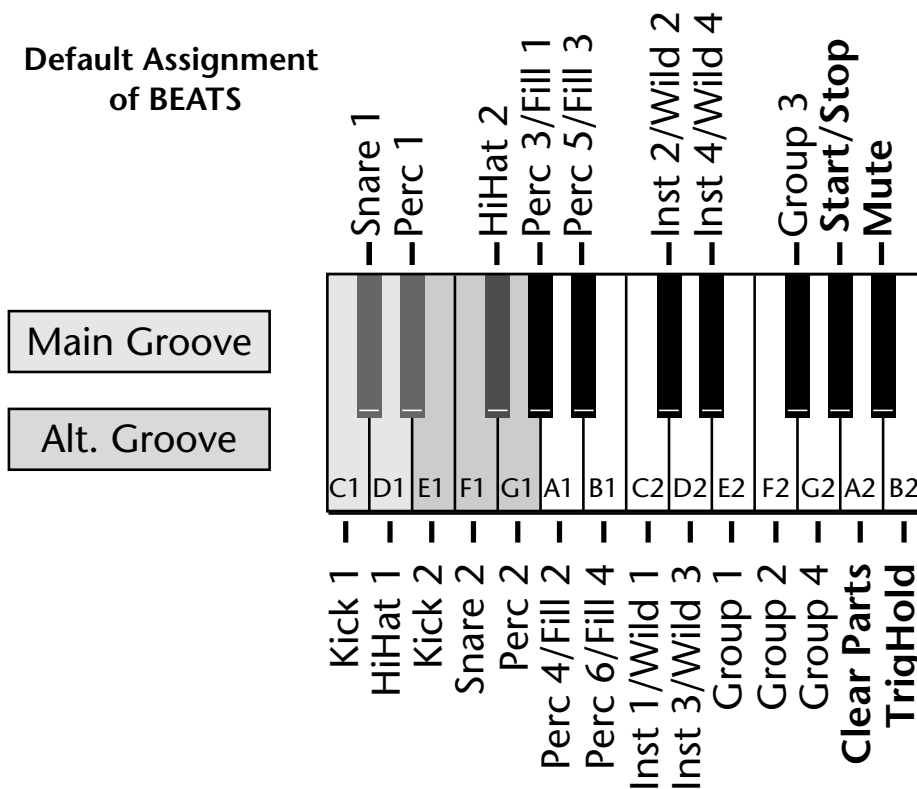

 Starting BEATS mode with the Start/Stop key allows you to start the sequencer rolling silently. Then you can bring Parts in and out using the "Busy" control.

 If Mute is set to 1-bar, the Part mutes for 1 bar then un-mutes.

 Start/Stop doesn't clear latched parts when it stops the sequencer. Any trigger played after stopping will not only start the sequencer and play that trigger's part, but also play all previously latched parts.

## BEATS Mode

 The Basic Channel is the MIDI channel currently displayed in the Main Screen.

- **Start/Stop Trigger** Starts the beat sequencer from the beginning of the sequence. When latched, pressing once starts and pressing again stops. When unlatched, the sequence runs as long as the key is held. Once the BEATS sequencer is started, it continues to run even if no triggers are active.
- **Clear Parts** Clears any enabled parts. This control provides a quick and easy way to shut off all latched Parts. Latch mode has no effect on this key.
- **Mute** Mutes all Parts while held, but the Beats sequencer continues running.
- **Trig Hold** When this key is held, all other Trigger Keys behave as if they were in Latch mode.

The BEATS sequencer plays as long as any BEATS triggers are active. BEATS Riffs can also be **Restarted** using a MIDI Song Start command even if the BEATS channel is not currently selected. The Audition LED illuminates whenever the BEATS sequencer is running (even if no Parts are playing).

Pressing the Audition button or starting a Demo causes the Beats sequencer to stop. Pressing the Audition button plays Parts 1-4 & 16 on "bts:" presets.

**All Arp/BEATS parameters are saved with the Multisetup.** (See "Restoring Multisetups" on page 196 for more information.)

This screen turns BEATS mode on and has several other features which allow flexible control over BEATS mode. There are several status modes that determine when BEATS will be turned on and which Riff will be used.

BEATS and BEAT Triggers can be set to different MIDI channels. This allows you to perform on two MIDI channels at once with a keyboard that only transmits on a single MIDI channel.

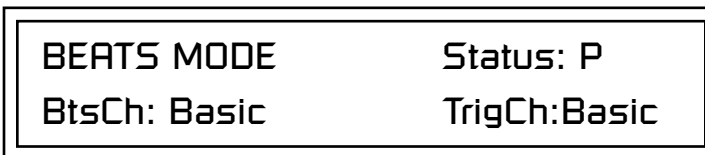

### Status

- **Off** . . . . . BEATS mode off.
- **On** . . . . . BEATS mode on. The Riff assigned in the preset is used.
- **P** . . . . . BEATS mode is turned on *ONLY* if the Riff assigned in the preset is a "BTS" riff. The Riff assigned in the preset is used. (Default setting)
- **M** . . . . . BEATS mode on. The Master Riff is used (Arp/Beats menu).

BEATS MODE	Status: P
BtsCh: Basic	TrigCh:Basic

### Beats Channel (BtsCh)

- **01-16** . . . . . Selects the MIDI channel on which BEATS play.
- **Basic** . . . . . BEATS play on the MIDI channel displayed in the Main Screen.

### Trigger Channel (TrigCh)

- **01-16** . . . . . Selects the MIDI channel on which Trigger Keys will be active.
- **Basic** . . . . . Sets the Trigger Keys to the MIDI channel displayed on the Main Screen.



If you don't select a "bts:" preset, only the first trigger key will work.

Riffs marked "BTS" have 16 parts. Riffs without "BTS" have only 1 part.

### ► To Play BEATS (Quick Start)

1. Select any preset with the **bts:** prefix.
  2. Play the keyboard keys from C1 to B2.
  3. Refer to the "Default Assignment" diagram on page 45 and try out each of the keys.
  4. Try out the Wild 1-4 knobs and other "bts:" presets. *Now check out the other cool BEATS controls explained in this chapter!*
- **If BEATS are not playing:** Locate the screen at the top of this page in the Arp/Beats menu and set the parameters exactly as shown.

### ► To Play BEATS on a different MIDI channel

This is just an example of how you might use this feature.

1. Set your MIDI keyboard to transmit on channel 2.
2. Set the Status to **P**.
3. Set the Beats Channel to **01**.
4. Set the Trigger Channel to **Basic**.
5. Select any "bts:" preset on channel 1 (*main screen*).
6. From the main screen, change to channel 2 and select another preset.
7. The Trigger Keys now play BEATS and the other keys play the preset on channel 2.

## BEATS Controllers

BEATS can be controlled using the front panel real-time controllers or external MIDI continuous controllers. **Controllers are patched to BEATS via the Preset PatchCords located in the Edit menu.** The following Preset PatchCord destinations control BEATS.

### Beat Velocity Group 1-4 (BtsVelG1 -> BtsVelG4)

Parts assigned to one of the four BEATS groups can have their velocity scaled by the controller input. Since most “bts” presets have velocity controlling volume, this control can be used to mix the relative levels of the Groups.

Beats velocity works as a percent *addition*. An input value of 0 (or no Cord) means change the velocity by 0%. A full scale modulation setting of 100% in the PatchCord adds 100% to the velocity value  $100\% + 100\% = 200\%$ . A Patchcord setting of -100% *subtracts* 100% from the velocity (making it 0). Beat velocity scalings are reset with a preset change.

### Beat Xpose Group 1-4 (BtsXpsG1 -> BtsXpsG4)

Parts assigned to one of the four BEATS groups are transposed by the controller input. Transpose works by shifting the keyboard position and not by changing the tuning of individual notes. Therefore, on a BEATS presets (bts), where different instruments are assigned to each key, Transpose has the effect of changing the instrument used by a particular part. This control ADDS to the Part Transpose set in the Beats Transpose screen (page 52). Beat transpose offsets are reset with a preset change.

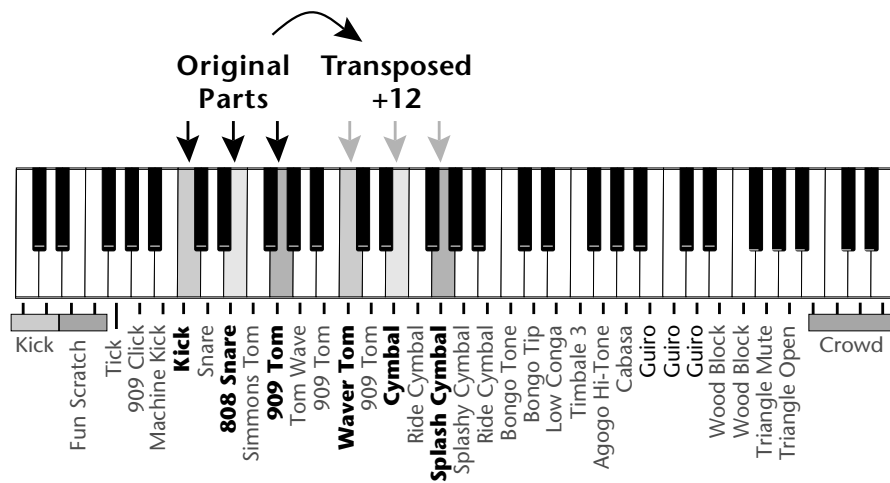

### Beat Busy (BtsBusy)

This destination determines which parts are enabled. Beat Busy will accept either positive or negative values.

- **Positive values** Add parts to whatever parts are triggered
- **Negative values** Remove parts that are triggered.



 A PatchCord amount of 50% is enough to drive Beat Busy to the maximum setting.

**Bidirectional Mod Wheel:**

Set Mod Wheel to BtsBusy with a Cord amount of +100, then add a DC bias to BtsBusy with a Cord amount of -50. Wheel now adds or subtracts "Busyness".

Suppose the pitch wheel (which can output both positive and negative values) were connected to Beat Busy and four Key Triggers are down. As the pitch wheel is moved from center to fully up, the remaining parts will be enabled until the pitch wheel is fully up and all parts are playing. Moving the pitch wheel from center to fully down, the four triggered parts are sequentially removed until at the most negative position of the wheel, no parts are playing.

The Busy control acts on the BEATS condition whenever the control is changed. Playing more triggers without changing the Busy control simply adds them until the Busy control is changed again, at which point it will possibly add or subtract parts as needed.

The interaction between the Busy control, Triggers, Part Velocity and Group Velocity can get complicated, but works according to this rule:

**WHICHEVER CONTROL WAS LAST CHANGED TAKES OVER**

When interacting with the Group Velocity scale control, the Busy control ignores group velocity even when it is set to zero, enabling and disabling parts as necessary. If the Group Velocity is changed *after* the Busy control, it takes control, scaling parts as it deems necessary.

The Busy control *does* take the Part velocity into account when adding and subtracting parts. If a part has a velocity of 0%, it is removed from the list of parts that the Busy control adds or subtracts. Therefore, you can use the Part Velocity control to remove parts you don't want to hear.

 **Cool Tip!** Connecting Key Pressure to Beat Busy at 50% increases BEAT complexity the harder you press.

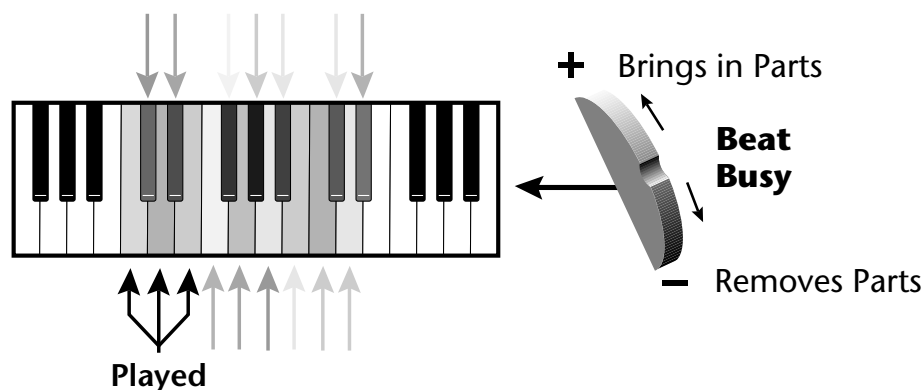

Positive controller values bring in new Parts and negative controller values remove Parts that are latched or held. In this example, the Pitch Wheel is connected to Beat Busy since it outputs negative as well as positive values.

**Beat Variation (BtsVari)**

Beat Variation varies which Parts are brought in and out using the Beat Busy control. Increasing this control mixes up the order in which Parts are brought in and out, thus providing even more permutations to the BEAT.

## Beats Trigger Layout



Save your Beats Trigger Layouts and all other Arp/BEATS parameters using the "Save Setup" function located in the Save/Copy menu.

This screen assigns the BEATS triggers to keyboard notes on the BEATS channel. For each Part, Group and Control Key you can select the following options:

- **Key** . . . . . Selects which keyboard key triggers the Part
- **Latch** . . . . . The first key press turns the Part on, the next turns it off.
- **Unlatch** . . . . . The Part plays only while the key is held.
- **1-bar** . . . . . The Part plays for one bar then stops.

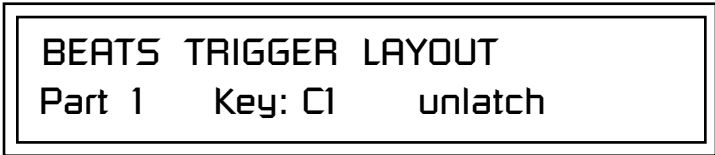

### 1-Bar Trigger Option

The 1-bar option requires a bit of explanation. When a trigger key is pressed before the last beat of the measure, the part will continue playing until the end of the measure. If the Trigger Key is pressed after the last beat of the measure, the part waits until the next measure before playing. Then it plays for the entire measure and stops. The time signature and the measure bounds are determined by the particular BEATS Riff you are playing.

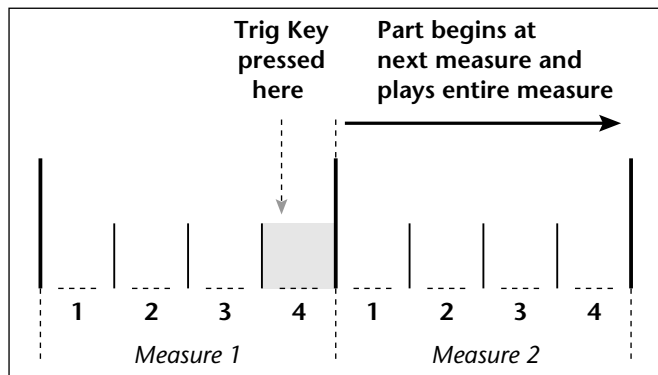
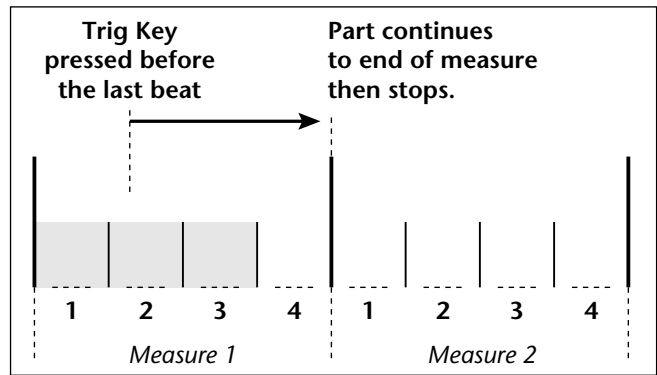

## Beats Trigger Offset

This function slides the Beats Trigger keys (*assigned in the previous screen*) up and down the keyboard. This makes it easy to change the keyboard location of the trigger keys without having to re-assign each key. A positive offset moves the group of triggers up the keyboard by the designated number of keys. Negative offsets move the trigger group lower on the keyboard.

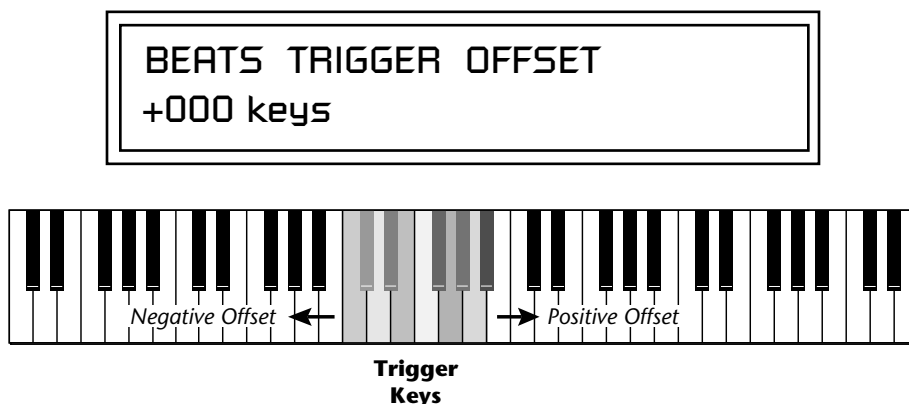

Beats Trigger Offset slides the entire group of beats triggers up or down the keyboard.

## Beats Part Velocity

Each note of a BEATS Riff can have its recorded velocity scaled by a value (from 0 to 120%) of the recorded velocity or the actual played velocity of the trigger key can be used (trigger vel). For example, if a note's velocity is 80, scaling by 110% will increase the note's velocity to 88. This feature allows you to control the mix of the different parts in advance or "on-the-fly" as you play. If a part's velocity is set to 0%, that part will be removed from the mix.

Select Part

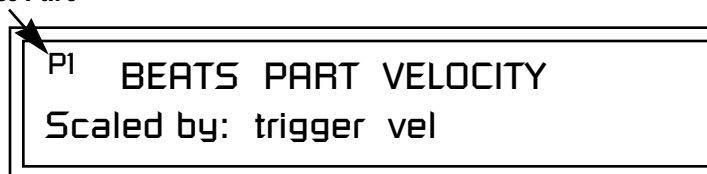

### ► To Set the Velocity for each Part

1. Press the left cursor button to move the cursor under the Part field.
2. Select the Part number using the Data Entry Control. Parts 1-16 can be selected. (*All parts, shown as an "A", can be edited at once if "Edit All Layers" is enabled in the Master menu.*)
3. Move the cursor to the bottom line using the cursor keys and adjust the Velocity Scaling percentage using the Data Entry Control.
4. Repeat steps 1 through 3 for all the Parts you wish to adjust.
5. Press the Enter/Home button or use the cursor keys to move the cursor back to the screen heading.

## Beats Part Transpose

Each Part of a BEAT Riff can be transposed up to 36 semitones up or down. Transpose works by shifting the keyboard position and not by changing the tuning of individual notes. Therefore, on a BEATS preset (bts:), where different instruments are assigned to each key, **Transpose has the effect of changing the instrument used by a particular part.** On a preset where a single sound covers the entire keyboard, Transpose will actually transpose the sound.

Select Part



### ► To set the Transposition for each Part

1. Press the left cursor button to move the cursor under the Part field.
2. Select the Part number using the Data Entry Control. Parts 1-16 can be selected. *(All parts, shown as an "A", can be edited at once if "Edit All Layers" is enabled in the Master menu.)*
3. Move the cursor to the bottom line using the cursor keys and adjust the Transposition in semitones using the Data Entry Control.
4. Repeat steps 1 through 3 for all the Parts you wish to adjust.
5. Press the Enter/Home button or use the cursor keys to move the cursor back to the screen heading.

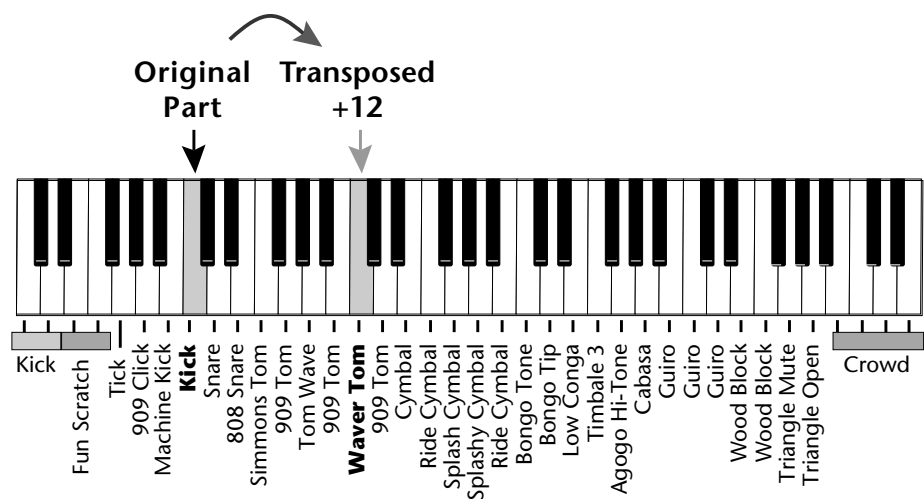

## Beats Part Group

This screen is where you assign Parts to one of the four Groups. By grouping, you can play multiple parts with a single key. A part can be in one and only one group, or in no groups.

Select Part

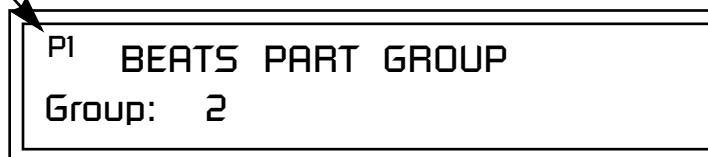

*All Parts assigned to a Group will stop playing when the Group key is triggered, then untriggered even if the individual Parts in the Group are latched.*

### ► To Assign a Part to a Group

1. Press the left cursor button to move the cursor under the Part field.
2. Select the Part number using the Data Entry Control. Parts 1-16 can be selected. (All parts, shown as an "A", can be edited at once if "Edit All Layers" is enabled in the Master menu.)
3. Move the cursor to the bottom line using the cursor keys and select the Group (1-4 or none) using the Data Entry Control.
4. Repeat steps 1 through 3 for all the Parts you wish to assign.
5. Press the Enter/Home button or use the cursor keys to move the cursor back to the screen heading.

## Master Riff

The Master Riff is selected from this screen. The Master Riff is used when Master (M) is selected for BEATS in Beats mode enable screen.



### ► To Assign the Master Riff

1. Use the cursor buttons to move the cursor to the lower line of the display.
2. Select the desired Riff using the Data Entry Control. (BEATS Riffs are identified by the **BTS** prefix.)
3. If there is more than one ROM in XL-1 you can select Riffs from either ROM set. Move the cursor under the ROM ID and select using the Data Entry Control.
4. Press the Enter/Home button or use the cursor keys to move the cursor back to the screen heading.

## Riff Tempo

This setting determines whether **Riff Tempo** (the tempo stored with each Riff) or the **Current Tempo** (the Base Tempo from the Master Clock) will be used for BEATS.

To control the Riff Tempo from MIDI clock, set Riff Tempo to “use current tempo” and Base Tempo to “use MIDI”.

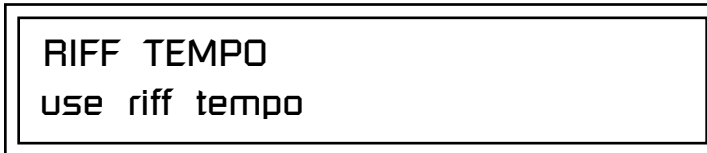

### ► To Set the Riff Tempo Mode

1. Use the cursor buttons to move the cursor to the lower line of the display.
2. Select “use riff tempo” or “use current tempo” using the Data Entry Control.
3. Press the Enter/Home button or use the cursor keys to move the cursor back to the screen heading.

## Riff Controllers

Riffs contain real-time control information. This function allows you to turn these controllers On or Off for the Riffs. This control affects Audition Riffs as well as BEATS Riffs.



### ► To Turn Riff Controllers On or Off

1. Use the cursor buttons to move the cursor to the lower line of the display.
2. Select “use riff controllers” or “ignore riff controllers” using the Data Entry Control.
3. Press the Enter/Home button or use the cursor keys to move the cursor back to the screen heading.

### *MIDI Song Start*

This function enables or disables MIDI Song Start for the Arpeggiator and Riffs. The MIDI Song Start option restarts the arpeggiator and/or Riff (BEAT) to the beginning when a MIDI Song Start command is received. This is useful for synchronizing arpeggios and BEATS when recording into, or playing along with a sequencer. You can choose to resync: Arp, Riff, both Arp and Riff, or disable MIDI Song Start.

**MIDI SONG START**  
resyncs arps & riffs

### *Arp/Riff MIDI Out*

This parameter selects whether or not the Arpeggiator and/or Riff (BEATS) note data is sent to the MIDI out port. This feature lets you use XL-1 as an arpeggiator or sequencer for your other MIDI instruments. It also lets you record the arpeggios and Riffs into a MIDI sequencer. You can choose to transmit: Arpeggiator data, Riff data, both Arp and Riff data, or nothing.

**ARP/RIFF MIDI OUT**  
don't transmit

## Arpeggiators

An arpeggiator moves a pattern of notes sequentially over a range of the keyboard. Xtreme Lead has the unique ability to play a different arpeggiator on each MIDI channel!

Arpeggiator settings can be defined as part of the preset (using the Arp parameters in the Edit menu), or globally in the Arpeggiator menu. The preset and master arpeggiators have the same parameters which we define in this chapter.

The Arp field in the main screen defines which arpeggiator settings will be used. "M" uses the master Arpeggiator settings and on/off status (as defined in the Arpeggiator menu). "P" uses the preset's arpeggiator settings and on/off status (as defined in the Edit menu). Choosing "On" uses the preset's arpeggiator settings regardless of whether or not it is turned on in the Edit menu and Off turns off the arpeggiator regardless of the settings and status specified in either menu.



**SAVE your Arp setups**  
and name them using the "Save Setup" function located in the Save/Copy menu. See "Saving Multisetups" on page 197.

Arp Settings in the  
Preset are Used

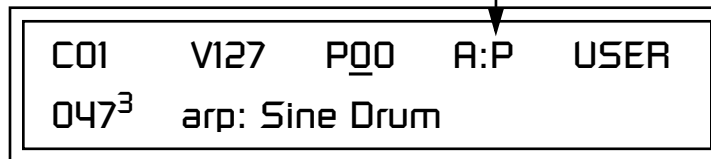

All arpeggiators share XL-1's master clock and its current setting. The master clock can be XL-1's internal clock or an external MIDI clock. Although the arpeggiators use the master clock setting, the tempo divisor can be unique for each arpeggiator setup.

Arpeggiator modes include up, up/down, forward assign, backward assign, forward/backward assign and random as well as play *Patterns*. Patterns are pre-recorded sequences of notes and rests. All key-on notes play the pattern. For example, if you play a chord, all the notes in the chord play the pattern in harmony. Xtreme Lead contains 200 factory patterns and 100 user definable patterns.



## Arp Controllers

The Arpeggiators can be controlled using the front panel real-time controllers or external MIDI continuous controllers. Controllers are patched to Arps via the Preset PatchCords located in the Edit menu. See *“Preset Patchcords” on page 159*. The following Preset PatchCord destinations control the Arpeggiators.

### **Arpeggiator Resolution (ArpRes)**

This control changes the Arpeggiator Note Value. It *adds* to the note value set in the Arpeggiator Note Value screen. See *“Note Value” on page 59*.

### **Arpeggiator Extension (ArpExt)**

This control changes the Arpeggiator Extension Count. It *adds* to the extension count programmed in the Arpeggiator Note Value screen. See *“Extension Count” on page 61*.

### **Arpeggiator Velocity (ArpVel)**

This control changes the Arpeggiator Velocity Value. It *scales* the velocity value set in the Arpeggiator Note Value screen. See *“Velocity” on page 60*.

### **Arpeggiator Gate (ArpGate)**

This control changes the Arpeggiator Gate Time. It *adds* to the gate time set in the Arpeggiator Gate Time screen. See *“Gate Time” on page 60*.

### **Arpeggiator Interval (ArpIntvl)**

This control modulates the Arpeggiator Extension Interval. It *adds* to the extension programmed in the Arpeggiator Extension Interval screen. See *“Extension Interval” on page 61*.

## Master Arpeggiator Parameters

### ► To Access the Master Arpeggiator Parameters

1. Press the Arpeggiator menu button lighting the LED. The Arpeggiator menu screen displays the menu page most recently selected since powering up Xtreme Lead. The cursor appears below the first character of the screen heading on line one.
2. Use the right cursor button to advance the cursor to the first field in the bottom line of the screen.
3. Now, use the Data Entry Control to access the various Master Arpeggiator parameters.
4. Save your Arpeggiator settings using the *“Save Setup”* function on the Save/Copy menu.

### Status

The Status parameter turns the Master Arpeggiator on and off. The Channel Arpeggiator setting in the main screen overrides this setting. For example, if you set the Arpeggiator in the main screen to “off,” and turn it “on” here, it still will not play.



### Mode

The Mode parameter determines the direction or pattern mode of the arpeggiated notes.





The eight arpeggiator modes are:

- **Up** Held notes arpeggiate continuously from lowest to highest pitch.
- **Down** Held notes arpeggiate continuously from highest to lowest pitch.
- **Up/Down** Held notes arpeggiate continuously from lowest to highest pitch, then from highest to lowest, then repeat this cycle.
- **Fwd Assign** Held notes arpeggiate continuously in the order in which the keys were pressed.
- **Bkwd Assign** Held notes arpeggiate continuously in the reverse order in which the keys were pressed.
- **Fwd/Bkwd** Held notes arpeggiate continuously in the order in which the keys were pressed, then arpeggiate in the reverse order that they were pressed. The cycle is then repeated.
- **Random** Held notes arpeggiate continuously in a random fashion.
- **Pattern** Held notes play the selected pattern (see “Pattern” on page 59 for details).

## Note Value

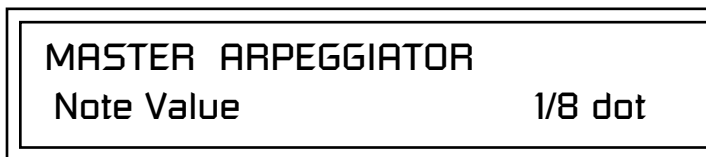
The Note Value determines the duration of each note played. This parameter is used in non-pattern mode only.



 Note value has no effect when the mode is set to "pattern."

Following is a list of possible Note Values and the relative number of clocks used for each.

Note Value	MIDI Clock
<b>Double Whole Note</b> .....	192
Dotted Whole Note.....	144
Double Note Triplet .....	128
<b>Whole Note</b> .....	96
Dotted Half Note.....	72
Whole Note Triplet .....	64
<b>Half Note</b> .....	48
Dotted Quarter Note .....	36
Half Note Triplet .....	32
<b>Quarter Note</b> .....	24
Dotted Eighth Note.....	18
Quarter Note Triplet.....	16
<b>8th Note</b> .....	12
Dotted 16th Note .....	9
8th Note Triplet.....	8
<b>16th Note</b> .....	6
Dotted 32nd Note .....	4.5
16th Note Triplet.....	4
<b>32nd Note</b> .....	3

## Arpeggiator Pattern Speed

The Arpeggiator Pattern Speed parameter lets you change the playback rate of Patterns by 1/4x, 1/2x, 1x (normal), 2x or 4x normal speed.

## Pattern

This field lets you choose the pattern used when the arpeggiator Mode is set to "Pattern." There are 200 factory programmed patterns and you can create an additional 100 user definable patterns (see "Editing a User Arpeggiator Pattern" on page 66).

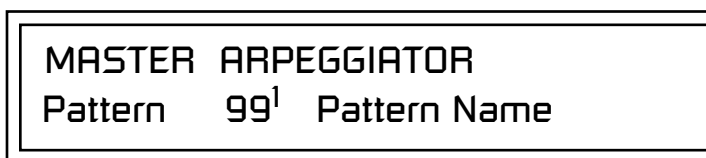

## Velocity

The Velocity parameter determines the velocity at which each note arpeggiates. Velocity can be defined by the velocity value specified (from 1 through 127), or by the actual velocity of the played note (played). Bear in mind that velocity values do not have an effect on the sound unless the preset is programmed to respond to velocity.

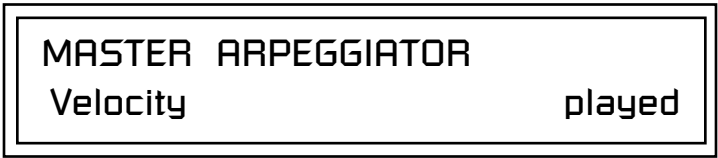

## Gate Time

The Gate Time parameter works together with the Note Value parameter. Just as Note Value defines the length of a note, the Gate Time sets the percentage of the Note Value time played. This can have a dramatic effect on the sound depending on how the envelope generators are programmed.

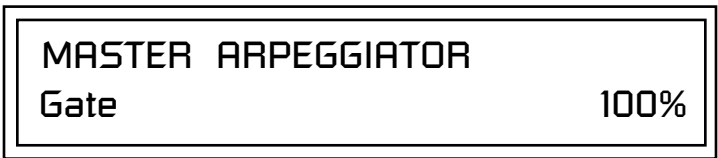

 The *note-on time* is used for the start-of-time when calculating note durations. See "Duration" on page 63.

With a Gate Time setting of 100% the note is held on until the next note starts. The envelope generators never advance to the Release stages. With a Gate Time setting of 50%, the note is released halfway through the note cycle and the envelope generators proceed to their release stages until the next note occurs. Refer to the following illustration.

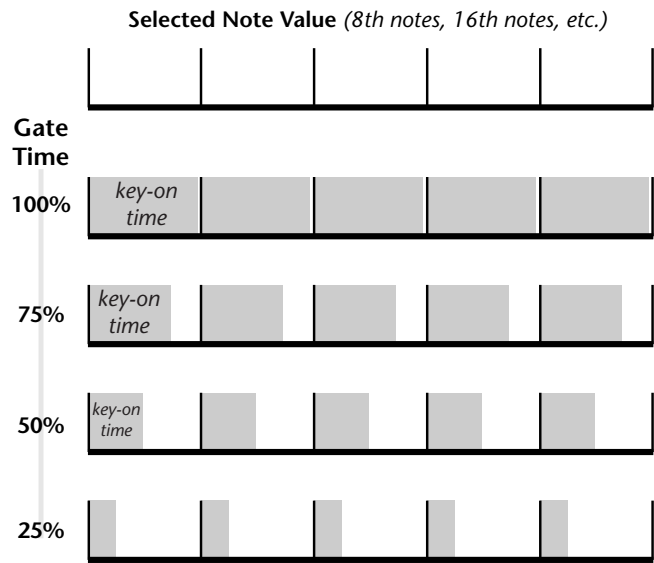

### Extension Count

The Extension Count parameter specifies how many times the Extension Interval is carried out. With an Extension Count of 0, the arpeggio plays only the notes pressed. With an Extension Count of 1, the arpeggio plays the notes pressed, then plays the same notes (in the same order), transposed by the Extension Interval amount. The cycle is then repeated.



For example, with the Extension Interval set to 12 (an octave) and an Extension Count of 2, and with the Arpeggiator Mode set to Fwd Assign, if you played E2, then C2, then G2, the arpeggiated sequence would consist of: E2, C2, G2, then E3, C3, G3, and then E4, C4, G4. The Extension Count values range from 0 through 15. Refer to the following illustration.

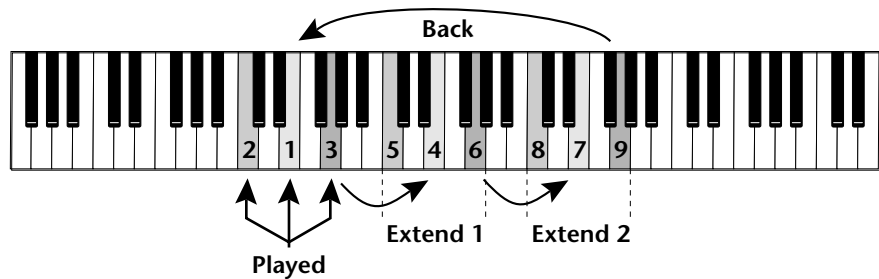

### Extension Interval

The Extension Interval specifies the additional intervals played when you press a key. For example, suppose you played C2 with an Interval of 7 (a Major 5th), Up mode, and an Extension Count of 2. The arpeggio alternates between C2 and G2.

The Extension Interval values range from 1 through 16.



## Sync

The Sync parameter defines when a note is played in relation to when the key is pressed. When set to “Key Sync”, the note sounds the instant a key is pressed. When set to “Quantized”, the note does not sound until the next occurrence of the selected note value.

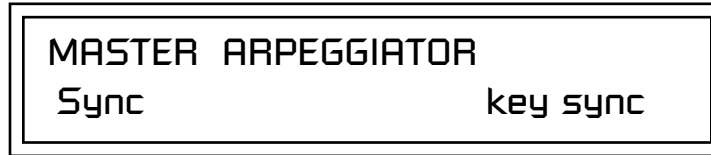

The following diagram illustrates how Key Sync and Quantize work.

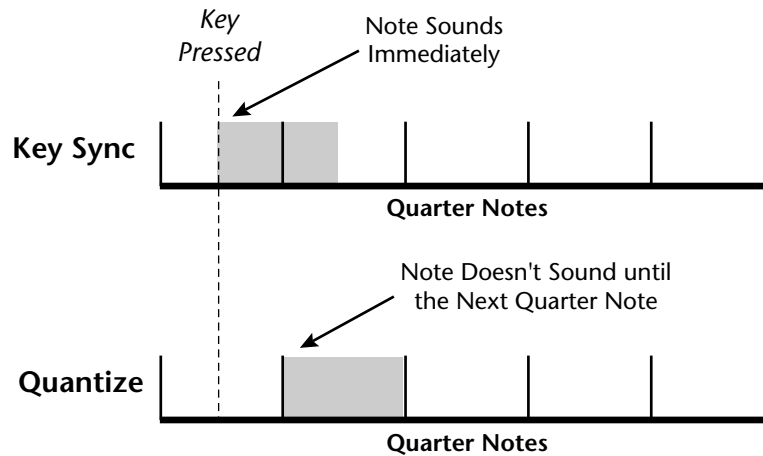

## Pre-Delay

The Pre-Delay value determines how long the arpeggiator is delayed before becoming active after the first “note-on.” During the pre-delay period, notes are played normally (as if the arpeggiator was off). After the pre-delay period has elapsed, the arpeggiator kicks in. Once you release all the keys on the controller, the pre-delay starts over with the next note-on. In combination with the Duration parameter, Pre-Delay lets you change the arpeggio patterns to create many more variations.

You can play the preset normally as long as you don't hold the notes longer than the Pre-Delay. If you do, the arpeggiator starts in. When used in conjunction with multiple arpeggiators or BEATS mode, Pre-Delay allows you to offset the time between the different patterns.

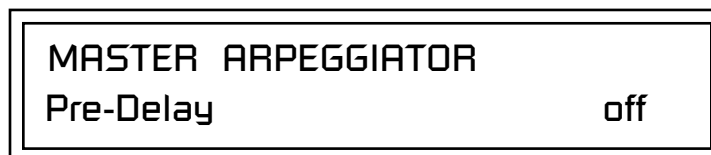

## Duration

This parameter defines how long the arpeggiator plays before stopping. The Duration is specified in note values. Therefore if an arpeggio were running at a 16th *Note Value* and the Duration were set to a whole note, the arpeggiator would play 16 steps before stopping. After the duration has elapsed, the arpeggiator remains inactive until the key is released. If Duration is set to Off, the arpeggio repeats as long as the notes are held (Infinite Duration).

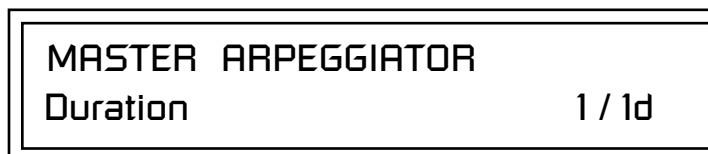

Duration can be used to modify the patterns and increase the possible pattern combinations and variations. Because this parameter limits the length of arpeggiator play time, it can change the arpeggio pattern when the Duration is less than the length of the arpeggio. You can set the arpeggio to repeat continuously using the *Recycle* function described below.

## Post-Delay

This parameter is only relevant when both the "Duration" and "Recycle" parameters are not in the "Off" state. The Post-Delay value determines how long the arpeggiator is delayed after the Duration period. (*Please refer to the diagram on the following page*). During the post-delay period, notes are played normally (as if the arpeggiator was off). After the post-delay period has elapsed, the arpeggiator either jumps to the beginning of the Pre-Delay period or to the beginning of the Duration period depending on the Recycle setting.

If the arpeggiator is playing an extension when the Duration expires, the notes in the extension will continue to sound during the Post-Delay (*and Pre-Delay if on*). On the next pass through the Duration period, the extension continues where it left off.

Post-Delay increases the number of possible variations in the beat and allows the recycle loop to be set to an exact measure of time.



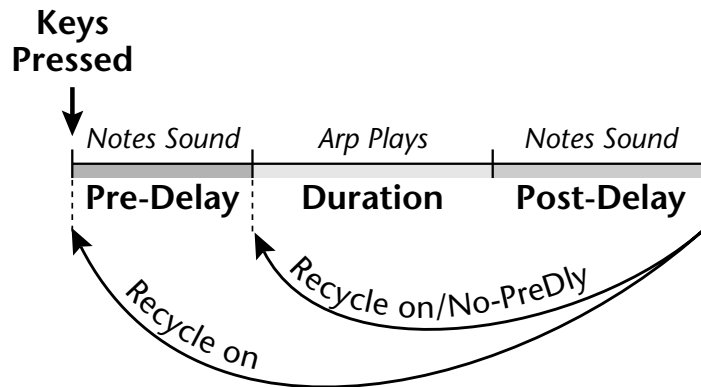

*Recycle*

This parameter works together with the *Duration* and *Pre/Post Delay* parameters. When these are enabled without one of the Recycle options turned on, the pattern or arpeggio normally stops. With Recycle On, the arpeggio instantly resets the pattern to the beginning of the Pre-Delay period after the duration value has elapsed and repeats the pattern or arpeggio. Another option called “on/No-PreDelay” bypasses the predelay period.

MASTER ARPEGGIATOR	
Recycle	on/No-PreDly

*Keyboard Thru*

When enabled, Keyboard Thru merges the notes not arpeggiated with the arpeggiated notes. This gives the effect of two parts playing at once.

MASTER ARPEGGIATOR	
Keyboard Thru	off

*Latch*

With Latch mode On, any notes you play remain on until you press them again. Latched notes can be halted by turning Latch off in this screen, or by turning off the Arpeggiator for the channel in the main screen.

MASTER ARPEGGIATOR	
Latch	on



## Key Range

Use the Key Range parameter to set the keyboard range for the arpeggiator. Notes inside the range will arpeggiate while notes outside the specified range will not arpeggiate. Use the Extensions parameters to exceed the upper boundary of the Key Range (see the information about Extensions beginning on page 61).

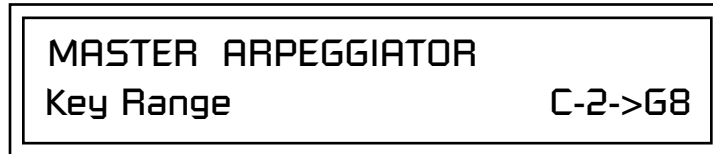

Move the cursor under the first key and use the Data Entry Control to define the lowest key to be arpeggiated. Move the cursor under the second key value and use the Data Entry Control to define the highest key to be arpeggiated.

## Send MIDI System Exclusive Data

Transmits the Arpeggiator Patterns via the MIDI out port as MIDI System Exclusive data to another Xtreme Lead or to a computer/sequencer for backup. Using the cursor key and the Data Entry Control, select the MIDI data you want to transmit. See *Send MIDI System Exclusive Data* in the Master chapter for additional details about recording SysEx.

### User Patterns

Transmits all the User patterns.

### 00<sup>0</sup> to 99<sup>0</sup>

Transmits only the individual pattern you have selected.



*Send data as you would a regular sequence. Sending data in one huge chunk may clog the MIDI input buffer on Xtreme Lead.*

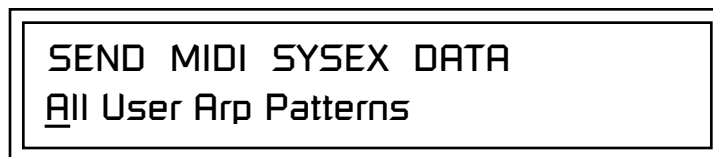

## Editing a User Arpeggiator Pattern

**Bank 0** = User Patterns  
**Bank 1** = Factory Patterns  
**Bank 2** = Factory Patterns

 Before editing a Pattern, select Master Arpeggiator (M) in the main screen and set the Arpeggiator to the Pattern you are editing. This lets you hear the Pattern as you edit it.

Xtreme Lead lets you create and edit your own arpeggiator patterns. Using the Edit User Pattern menu, you can create up to 100 user patterns and each pattern can be up to 32 steps in length.

When you edit a pattern, you are writing directly into memory—no Save command is required. This is different from the Edit menu where you must Save a preset before it will be overwritten. If you want to modify an existing pattern and keep the original, you must first COPY the pattern you want to edit to another location using the function in the Copy menu (See page 195). Refer to the instructions below and the following parameter descriptions to create your own patterns.

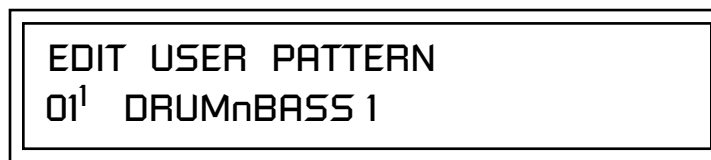

### ► To Select the Pattern to Edit

1. From the Edit User Pattern screen shown above, move the cursor to the bottom line and select the pattern you want to edit. The Enter LED begins flashing.
2. Press the Enter button to confirm that you want to edit the selected pattern. The "User Pattern Edit" page appears.

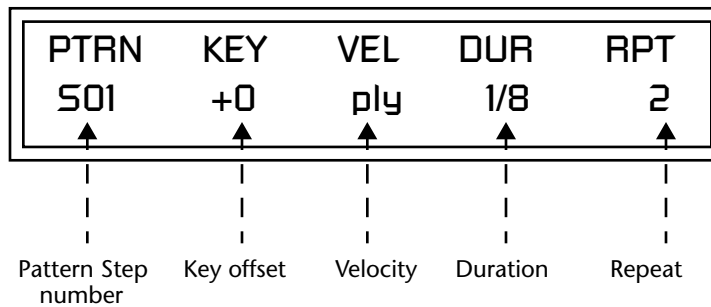

## Pattern Step Number

You can set up to 32 steps for each arpeggiator pattern. This field selects which step you will be editing from 1 to 32.

## Key

This parameter defines what happens during the current step. The Key parameter can do one of five different operations. Following is a description of each of the key functions and how to use them.

### Key Offset

This parameter defines not the actual note of the arpeggiator playback, but instead specifies the amount of offset, in semitones, from the original note played. You can set a Key Offset from -48 to +48 for each step. For example, if you play a “C” on the keyboard with the Key Offset amount for the first step set to “+1,” the first step in the pattern will be “C#.”

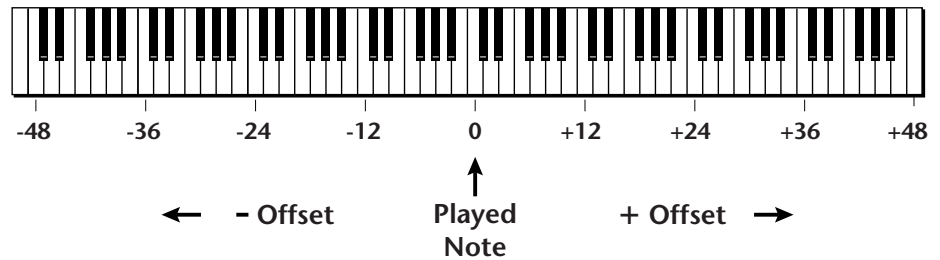

### Tie

This function *extends* the duration of notes beyond the values given in the duration field by “tying” notes together. You can tie together any number of consecutive steps.



**IMPORTANT:** The Gate function in the arpeggiator *MUST* be set to 100% when using the tie function, otherwise the tied note is retriggered instead of extended.

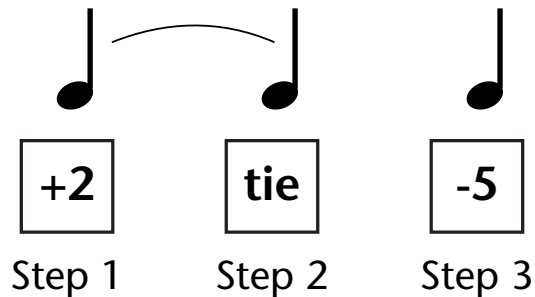

### Rest

Instead of playing a note, you can define the step as a Rest. The Duration parameter specifies the length of the rest. Rests can be tied together to form longer rests.

### Skip

This command simply removes the step from the pattern. The Skip feature makes it easy to remove an unwanted step without rearranging the entire pattern. You’ll be happy to know that the velocity, duration and repeat parameters are remembered if you decide to put the step back later.

### End

This command signals the end of the pattern. Any steps programmed after the step containing the End command are ignored.

### Velocity

Each note in the pattern plays using either a preset velocity value (from 1 through 127), or using the actual velocity of the played note (ply).

**Note:** Velocity values will not have an effect on the sound unless velocity is programmed to do something in the preset.

### Duration

This parameter sets the length of time for the current step, defined as a note value, based on the Master Tempo. The selectable note durations are described below.

<b>1/32</b>	32nd Note	<b>1/2t</b>	Half Note Triplet
<b>1/16t</b>	16th Note Triplet	<b>1/4d</b>	Dotted Quarter Note
<b>1/32d</b>	Dotted 32nd Note	<b>1/2</b>	Half Note
<b>1/16</b>	16th Note	<b>1/1d</b>	Dotted Whole Note
<b>1/8t</b>	8th Note Triplet	<b>1/1t</b>	Whole Note Triplet
<b>1/16d</b>	Dotted 16th Note	<b>1/2d</b>	Dotted Half Note
<b>1/8</b>	8th Note	<b>1/1</b>	Whole Note
<b>1/4t</b>	Quarter Note Triplet	<b>2/1t</b>	Double Whole Note Triplet
<b>1/8d</b>	Dotted Eighth Note	<b>2/1</b>	Double Whole Note
<b>1/4</b>	Quarter Note		

### Repeat

Each step can be played from 1 to 32 times. A repeat setting of "1" indicates the step will be played one time (not repeated one time or played twice).

#### ► To Edit a User Pattern

1. The first field in the Edit User Pattern field defines the pattern's step number. Start with the pattern Step 01.
2. Define the Key Offset, Velocity, Duration and Repeat values.
3. Repeat steps 1 and 2 until you have setup the desired number of steps in the pattern.
4. Set the Key Offset to "End" on the last step in the pattern.

## User Pattern Name

The User Pattern Name page lets you enter a name for any User Arpeggiator Pattern.

<u>P</u> TRN	KEY	VEL	DUR	RPT
S01	+0	ply	1/8	2

### ► To Name a User Pattern

1. From the Pattern Edit screen shown above, position the cursor under the PTRN field.
2. Turn the Data Entry Control clockwise. The following screen appears.

<u>U</u> SER PATTERN NAME
00 <sup>0</sup> Mod Spinach

3. Move the cursor to the bottom line and edit the Pattern name using the Data Entry Control and Cursor keys.
4. Move the cursor to the “Home” position (shown above) by pressing the Home/Enter button, then turn the Data Entry Control counterclockwise one click to return to the Pattern Edit screen.
5. Turn the Data Entry Control counterclockwise multiple clicks to jump back to the main Arpeggiator menu screen.

## Multi-Channel Arpeggiating

One of the coolest features in XL-1 is its ability to run multiple arpeggiators at the same time. The interactions of multiple note sequences can be complex and fascinating. XL-1 lets you run up to sixteen arpeggiator patterns at once! Even two or three patterns at once can create very complex sequences and dynamic landscapes of sound.

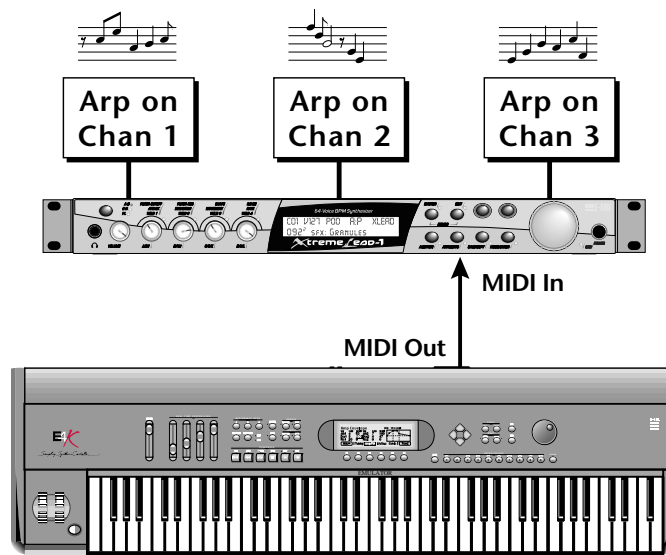

Master Keyboard transmitting on  
MIDI channels 1, 2, 3

Here's one way to use this ultra-powerful feature. There is one arpeggiator for each MIDI channel. In order to arpeggiate on multiple channels, you need a controller that can output multiple MIDI channels at once.

1. Set up your MIDI keyboard so that it outputs the entire keyboard on MIDI channels 1 and 2. This procedure varies with the type of keyboard you own. Refer to the owner's manual that came with your keyboard for instructions.
2. Put XL-1 into Multi mode. This is located in the Master menu, MIDI Mode page.
3. On the main screen, turn the arpeggiator "on" for MIDI channels 1 and 2. (We're only using two channels for now to keep it simple.) Select a different preset for each MIDI channel while you're at it.

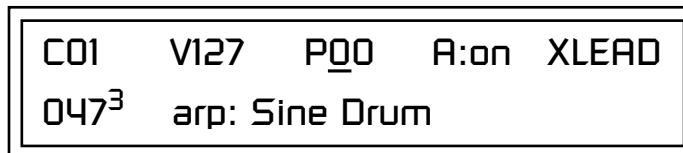

4. Start playing. You should be hearing two arpeggiators playing at once.

Try experimenting with presets and settings. For example:

- Change presets on one or both of the MIDI channels you are using (1 & 2). Since each factory preset has different arpeggiator settings, changing the preset not only changes the sound, but the arpeggiator settings as well.
- Press the Control button on the front panel to select “I-L” (the LED in the third row is illuminated). Adjust the front panel control knobs. These knobs usually control the arpeggiator on presets with the “arp:” prefix.
- Try changing one of the channel’s arpeggiator setting to “M” instead of “on.” Now press the Arpeggiator Menu button and adjust the arpeggiator parameters in real time.
- From the Master Arpeggiator menu, set the Mode to Pattern then explore the different patterns. There are 300 patterns available!

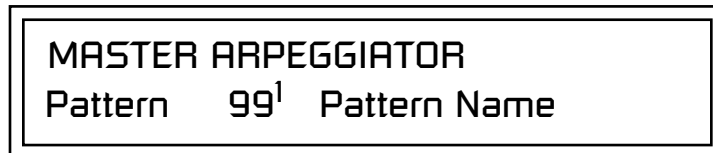

Now you’re getting the picture. This machine is beyond awesome!

## Using a MIDI Interface to Channelize Data

Not all keyboards or controllers can transmit on multiple MIDI channels at once. If your MIDI controller only transmits on a single MIDI channel, there are other ways to use the multi-channel arpeggiators. A MIDI interface such as Mark of the Unicorn’s MIDI Time Piece®, or a MIDI router box will convert data on one channel to any other channel or channels.

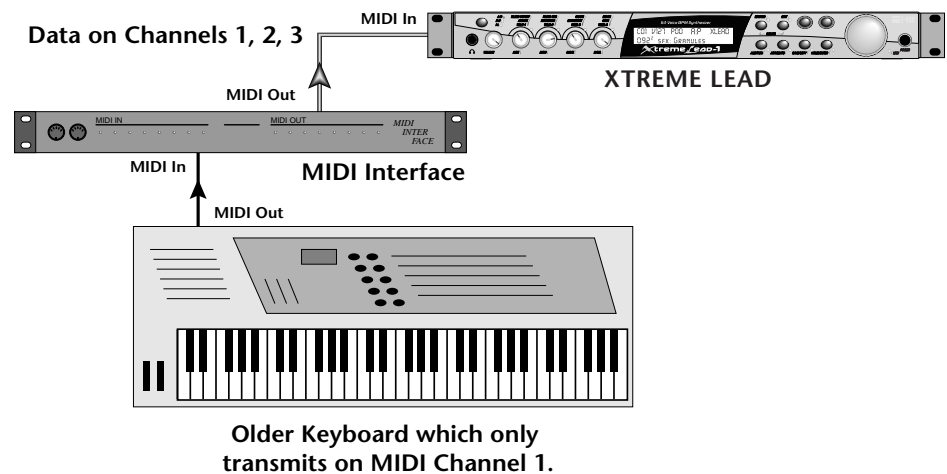

Your MIDI Interface may be able to output MIDI data on multiple channels at once.

**Arpeggiator/Beats Menu**  
**Using a MIDI Interface to Channelize Data**





# Master Menu

The Master menu contains functions that affect the overall operation of Xtreme Lead. For example, changing the Master Tune parameter changes the tuning of all the presets, not just the one currently displayed.

## ► To enable the Master menu

Press the Master button, lighting the LED. The Master Menu screen displays the menu page most recently selected since powering up Xtreme Lead. The cursor appears below the first character of the screen heading on line one.



**Warning:** Master Menu changes are automatically saved when you exit the menu. If the power is turned off before you exit the menu any changes you have made will be lost.

## ► To select a new screen

Press the Home/Enter button or press the Cursor button repeatedly until the cursor is below the screen title heading. Rotate the Data Entry Control to select another screen.

## ► To modify a parameter

Press either Cursor button repeatedly (or hold down the right cursor button while turning the Data Entry Control) until the cursor is below the desired parameter value. Rotate the Data Entry Control to change the value.

## ► To return to the main screen

Press the Master button, turning off the LED.

## Defining Master Parameters

### *Transpose/Tune*

Master setup parameters affect overall performance, range, and global effects. This section describes the Master parameters and how to define them.

The Transpose parameter transposes the key of all presets, in semitone intervals. The transpose range is  $\pm 24$  semitones.

Master Tune adjusts the fine tuning of all presets so that you can tune Xtreme Lead to other instruments. The master tuning range is  $\pm 1$  semitone in 1/64th semitone increments (1.56 cents). A master tune setting of "+00" indicates that Xtreme Lead is perfectly tuned to concert pitch (A=440 Hz).

<b>MASTER TRANSPOSE</b>	<b>TUNE</b>
+00 semitones	+00

### *Bend Range*

The Bend Range parameter sets the range of the pitch wheel. This affects only presets that have their individual Pitch Bend range (defined in the Edit menu) set to Master. The maximum pitch bend range is  $\pm 12$  semitones or one octave in each direction.

<b>MASTER BEND RANGE</b>
+/- 7 semitones

## Velocity Curve

You can modify incoming velocity data by a velocity curve in order to provide different types of dynamics in response to your playing, or to better adapt to a MIDI controller. The Master Velocity Curve lets you select one of thirteen master velocity curves or to leave the data unaltered (linear).

### MASTER VELOCITY CURVE 13

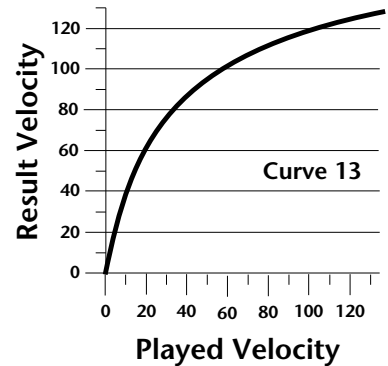
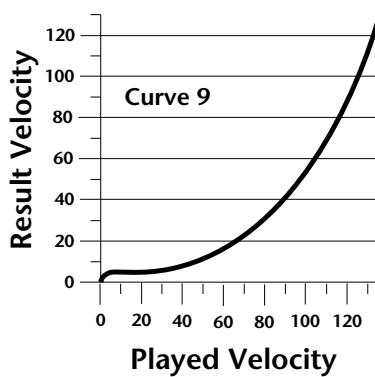
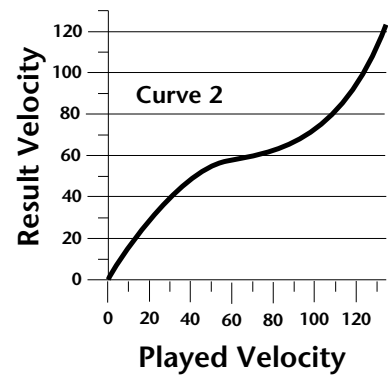
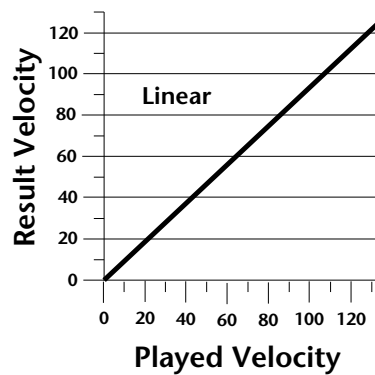

For a complete list of all available velocity curves, see “Velocity Curves” on page 225 of the Appendix.

## Mix Output

The Mix Output parameter allows you to override the routing assignments made in each preset and instead assign the outputs according to MIDI channel. For each of the 16 MIDI channels, you can select Send 1-4, or Preset. When Preset is selected, the output assignment defined in the Preset Edit menu is used.

MIX OUTPUT  
channel 16: use preset

MIX OUTPUT  
channel 15: Send 1

The *Sends* function as effect processor inputs (effect sends). The four Effect Sends allow you to get the most out of the two effect processors. For example, with Effect B set to an echo algorithm, you could route one MIDI channel to Send 3 and set the effect amount to 80%. Another MIDI channel could be routed to Send 4 with an effect amount of only 5%. This is almost like having two different effects!

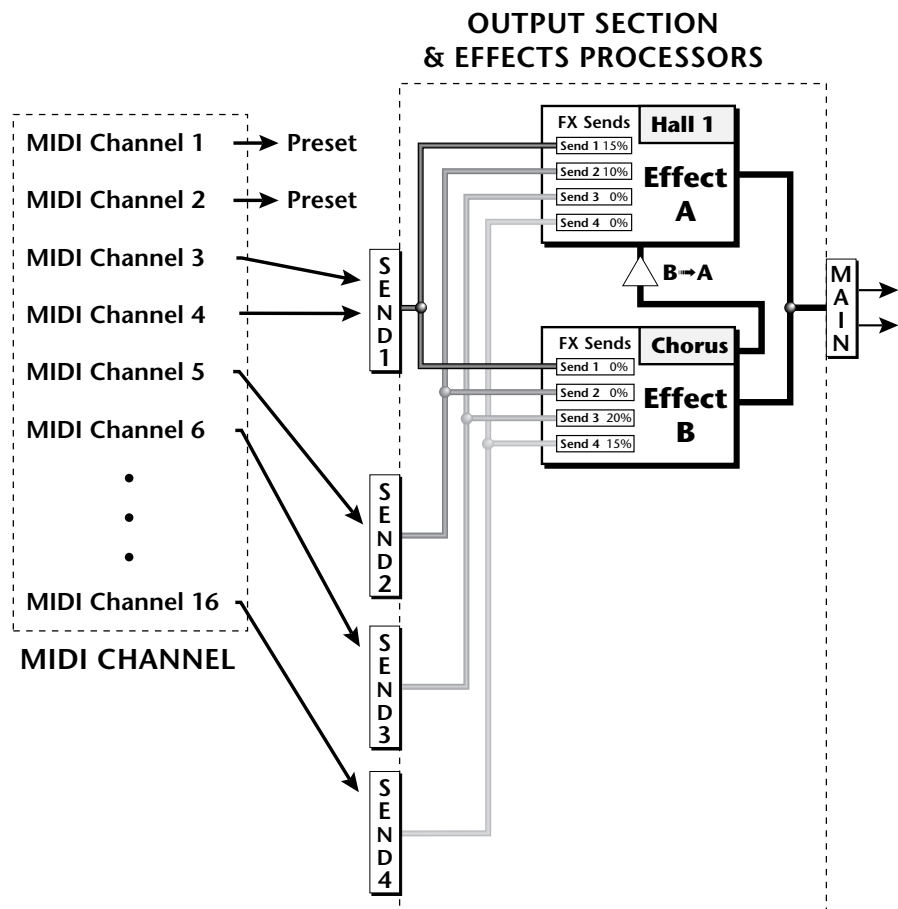

## Master Effects

The digital effect processors can be programmed as part of the preset (using the Edit menu) so that effects will change along with the preset. However, there are only two effect processors, and so you cannot have a different effect on each preset when in Multi mode.

The Master Effects settings assign the effect processors “globally” for all presets to provide a way to use the effects in Multi mode. Detailed information is presented in the Effects chapter (see Effects on page 177).

### *Effects Mode*

The FX Mode page enables or bypasses the effects. When the FX Mode is set to “bypass,” the effects are turned off on a global scale. This includes Effects programmed in the preset.

**FX MODE**  
enabled

### *Effects Multi Mode Control*

The routing scheme for the two stereo effects processors provides a lot of versatility. When in multi mode, you can “use master settings” which applies the Master menu effects settings to all 16 MIDI channels.

**FX MULTIMODE CONTROL**  
use master settings

If you want more control, you can use the “channel” setting which applies the effects settings of the preset on a specified channel to all the other channels. Changing the preset on the specified channel changes the effect.

**FX MULTIMODE CONTROL**  
preset on channel 1

If you are in Omni or Poly modes this parameter is disabled and the message in parentheses explains that XL-1 is currently in Omni mode.

**FX MULTIMODE CONTROL**  
(using Omni mode)

## Master FXA Algorithm

This function selects the type of effect used for the “A” effect. The following effect types are available.

### MASTER FXA ALGORITHM

#### Room 1

#### A Effect Types

- |                     |                       |
|---------------------|-----------------------|
| 1. Room 1           | 23. BBall Court       |
| 2. Room 2           | 24. Gymnasium         |
| 3. Room 3           | 25. Cavern            |
| 4. Hall 1           | 26. Concert 9         |
| 5. Hall 2           | 27. Concert 10 Pan    |
| 6. Plate            | 28. Reverse Gate      |
| 7. Delay            | 29. Gate 2            |
| 8. Panning Delay    | 30. Gate Pan          |
| 9. Multitap 1       | 31. Concert 11        |
| 10. Multitap Pan    | 32. Medium Concert    |
| 11. 3 Tap           | 33. Large Concert     |
| 12. 3 Tap Pan       | 34. Large Concert Pan |
| 13. Soft Room       | 35. Canyon            |
| 14. Warm Room       | 36. DelayVerb 1       |
| 15. Perfect Room    | 37. DelayVerb 2       |
| 16. Tiled Room      | 38. DelayVerb 3       |
| 17. Hard Plate      | 39. DelayVerb 4 Pan   |
| 18. Warm Hall       | 40. DelayVerb 5 Pan   |
| 19. Spacious Hall   | 41. DelayVerb 6       |
| 20. Bright Hall     | 42. DelayVerb 7       |
| 21. Bright Hall Pan | 43. DelayVerb 8       |
| 22. Bright Plate    | 44. DelayVerb 9       |

*FXA Parameters:  
Decay/HF Damping  
FxB -> FxA*

This page lets you define the parameters of the selected Effects algorithm. Use this page to setup the effect decay, high frequency damping amount and to route "B" effects through the "A" effects. See "Effect Parameters" on page 179 for more details.

FXA	DECAY	HFDAMP	FxB>FxA
	040	096	001

*FXA Send Amounts*

These parameters set the effects amounts for each of the four stereo effects busses. See "Master Effects" on page 182 for detailed information.

FXA SEND AMOUNTS	1:100%
2: 50%	3: 10%
	4: 0%

*Master FxB  
Algorithm*

This parameter selects the type of effect used for the "B" effect. The following effect types are available.

MASTER FxB ALGORITHM
Chorus 1

## B Effect Types

- |                |                        |
|----------------|------------------------|
| 1. Chorus 1    | 17. Ensemble           |
| 2. Chorus 2    | 18. Delay              |
| 3. Chorus 3    | 19. Delay Stereo       |
| 4. Chorus 4    | 20. Delay Stereo 2     |
| 5. Chorus 5    | 21. Panning Delay      |
| 6. Doubling    | 22. Delay Chorus       |
| 7. Slapback    | 23. Pan Delay Chorus 1 |
| 8. Flange 1    | 24. Pan Delay Chorus 2 |
| 9. Flange 2    | 25. Dual Tap 1/3       |
| 10. Flange 3   | 26. Dual Tap 1/4       |
| 11. Flange 4   | 27. Vibrato            |
| 12. Flange 5   | 28. Distortion 1       |
| 13. Flange 6   | 29. Distortion 2       |
| 14. Flange 7   | 30. Distorted Flange   |
| 15. Big Chorus | 31. Distorted Chorus   |
| 16. Symphonic  | 32. Distorted Double   |

### *FXB Parameters: Feedback/LFO Rate Delay Time*

The FXB parameters setup the characteristics of the effect. Use this page to define the feedback amount, the LFO rate and delay amount for the selected type “B” effect. See “Effect Parameters” on page 179 for details.

FXB	FEEDBK	LFORATE	DELAY
	000	003	0

### *FXB Send Amounts*

These parameters set the effects amounts for each of the four stereo effects busses. See the Effects chapter for detailed information.

FXB SEND AMOUNTS	1:100%
2: 50%	3: 10%
	4: 0%



# MIDI Parameters

## MIDI Mode

MIDI parameters control how the Xtreme Lead sends and receives MIDI data.

MIDI Mode selects one of the three MIDI modes: Omni, Poly or Multi mode.

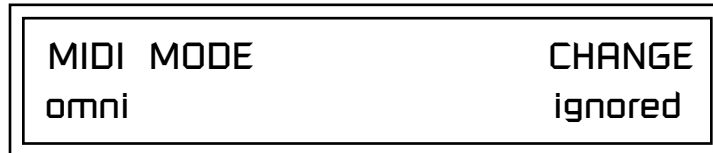

The **MIDI Mode Change** parameter specifies whether mode changes made through an external MIDI controller are accepted or ignored.

The MIDI modes are as follows:

### Omni

Responds to note information on all MIDI channels and plays the preset currently displayed in the main screen.

### Poly

Responds only to note information received on the currently selected MIDI channel (on the preset selection screen) and plays that channel's associated preset.

### Multi

Responds to data on any combination of MIDI channels and plays the specific preset associated with each of the MIDI channels. You must select multi mode for multitimbral operation.

## MIDI SysEx ID



**WARNING:** When transferring SysEx data from one Xtreme Lead to another, the ID numbers of both units must be the same.

This page defines the MIDI system exclusive (SysEx) device ID number. The SysEx ID lets an external programming unit to distinguish between multiple Xtreme Lead units connected to the same preset editor. In this case each unit must have a unique SysEx ID number.

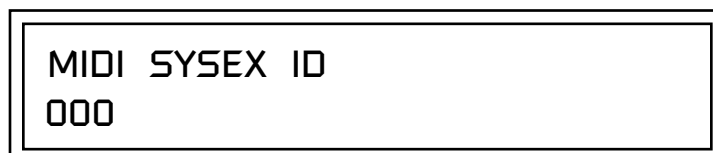

## MIDI Enable

MIDI Enable lets you turn each MIDI channel on and off independently when in Multi mode. This feature is helpful when you have other devices connected to the same MIDI line and do not want the Xtreme Lead unit to respond to the MIDI channels reserved for the other devices.

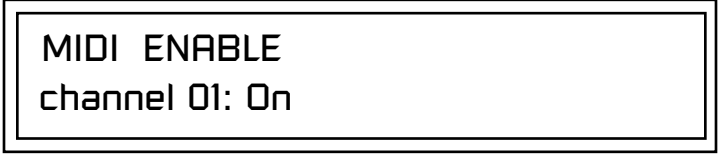

Because the MIDI Enable function only makes sense if you are in Multi mode, Xtreme Lead disables this feature when in Omni or Poly mode.

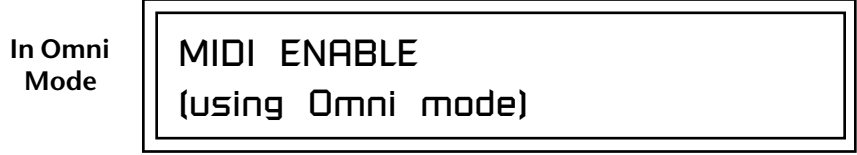
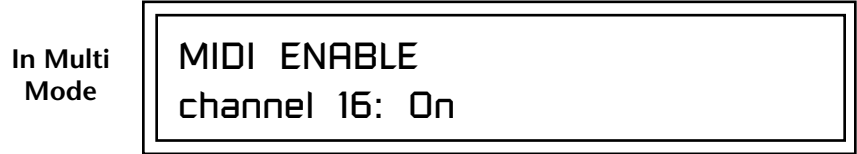

## MIDI Program Change -> Preset

You can also remap incoming MIDI program changes to a different numbered preset. This is a handy feature when your master keyboard cannot send a bank change or you want to reorder preset numbers. Any preset can be mapped to any incoming MIDI program change number.

For example, you could set up the Program -> Preset map to call up preset #12 whenever Xtreme Lead receives MIDI program change #26.

The four fields shown below are editable.

 The Program->Preset Change only works for program changes received in Bank 0.

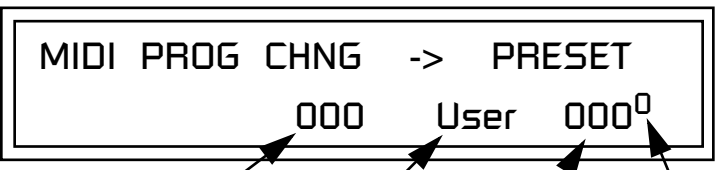

Incoming Program Change in Bank 0    ROM Bank    Program No.    Bank No.

 Programs and presets are the same thing. "Preset" is E-MU's term for MIDI Program.

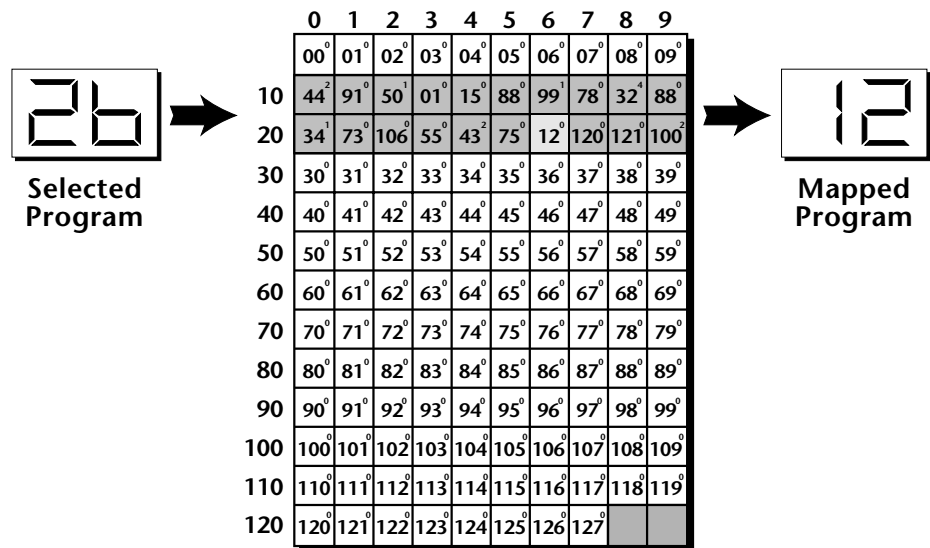

In this chart, program changes 10-29 have been remapped to new preset numbers. All other presets are selected normally.

### Receive Program Change

Use this function to instruct the Xtreme Lead to utilize or ignore incoming MIDI preset changes or Bank Select commands for each channel. Use the cursor buttons to select the channel number field, then use the Data Entry Control to select a channel number. Use the cursor button again to select the On/Off field and the Data Entry Control to change the value.

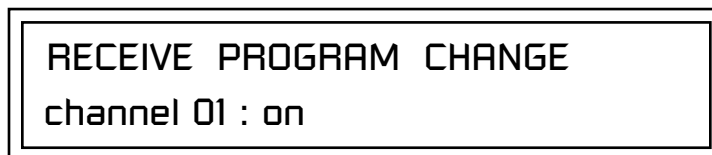

### Real-time Controller Assignment

Use these three pages to assign twelve real-time control sources. Each MIDI Controller is assigned a letter (A - L). The front panel Controller Knobs and twelve MIDI controller numbers share the A-L controller routings. **These screens let you select which MIDI real-time controllers numbers will be received (from 1 to 31 and from 64 to 119) and which controller numbers will be transmitted over MIDI if the front panel controls are turned.** The PatchCord routing and amount in the Edit menu determine what effect the controller has on each preset. Real-time controllers are shown in the PatchCord menu as MIDI A through MIDI L.



*Xtreme Lead factory presets have certain synth parameters assigned to each controller letter and so these are "Global" controller assignments.*

*For example, assigning a MIDI controller to "A" in this screen would let you control filter Fc for all the factory presets. See "Front Panel Knob Functions" on page 203.*

The Real-time Controller assignment also specifies which controller numbers are transmitted when the "Knobs MIDI Out" is enabled (see "Knobs/Riff MIDI Out" on page 86).

REALTIME CONTROLLER #			
A: 21	B: 22	C: 23	D: 24

REALTIME CONTROLLER #			
E: 25	F: 26	G: 27	H: 28

REALTIME CONTROLLER #			
I: 80	J: 81	K: 91	L: 93

**Note:** Controllers 7 and 10 are already assigned to Volume and Pan for each MIDI channel. Controllers 91 & 93 are the standard controller numbers for reverb and chorus send amounts.

Following are a few of the standardized MIDI Controller numbers as defined by the MIDI manufacturers association. The controllers shown in **Bold** are automatically routed to the destination (volume & pan) or have their own PatchCord source. Others, such as Portamento Time, can be routed using a PatchCord to have the desired effect.

- |                             |                   |
|-----------------------------|-------------------|
| <b>1 - Modulation Wheel</b> | <b>7 - Volume</b> |
| 2 - Breath Controller       | 8 - Balance       |
| 3 - Old DX7 Aftertouch      | 9 - Undefined     |
| <b>4 - Foot Pedal</b>       | <b>10 - Pan</b>   |
| 5 - Portamento Time         | 11 - Expression   |
| 6 - Data Entry              |                   |

## MIDI Footswitch Assign

Like the MIDI Controllers, you can assign three MIDI footswitches to MIDI footswitch numbers. Footswitches numbers are from 64-79. Destinations for the footswitch controllers are programmed in the PatchCord section of the Edit menu.

FOOTSWITCH CONTROLLER #		
1: 64	2: 65	3: 66

Following are a few of the standardized MIDI Switch numbers.

64 - Sustain Switch (on/off)	67 - Soft Pedal (on/off)
65 - Portamento (on/off)	69 - Hold Pedal 2 (on/off)
66 - Sostenuto (on/off)	

## Tempo Controller

This function allows a MIDI controller to change the Master Tempo. The Global Tempo is used for the clock divisor PatchCords, tempo-based envelopes and synced LFOs. (See “Clock Modulation” on page 98.) You can assign any controller number from 0-31, mono key pressure, or the pitch wheel to change the Global Tempo.

A different controller can be used to change the tempo up or down. The Pitch Wheel can be assigned to both the up and down parameters to vary the tempo up and down from a single controller. If any other controller is assigned to both the up and down parameters, Xtreme Lead redefines the center of the controller’s range as zero (so it acts like a pitch wheel).

MIDI Controller values are added to the Base Tempo with a range of  $\pm 64$ . When the controller is set to “off” the tempo returns to its original setting. This control has no effect when using an external clock.

TEMPO CONTROLLER#	CHAN
Up: 03    Down: 09	16

## Knob Preset Quick-Edit

 Quick Edit does not work while in the Edit menu with “Knobs Deep Edit” enabled.

“Quick-Edit” changes the initial controller setting in the preset whenever you move a Control Knob. This parameter selects whether or not the front panel Controller Knobs are used to Quick-Edit the currently selected preset. See “Real-time Control” on page 35 in the Operations chapter for more details.

<p><b>KNOBS PRESET QUICK-EDIT</b> disabled</p>
--

*Knobs  
Deep Edit*

This parameter specifies whether or not the front panel controller knobs can be used to edit parameter values in the Master or Edit menus. This is called “Deep-Editing.” With Knob Deep Edit disabled, the front panel controller knobs retain their function as real-time controllers even when in the Master or Edit modes.

**KNOBS DEEP EDIT**  
disabled

*Knobs/Riff MIDI Out*

This function allows you to select whether or not MIDI controller data is transmitted when you turn the front panel Controller knobs. The knobs transmit on the controller numbers defined by the Real-time Controller Assign parameter (see page 83). This function also enables or disables transmission of Riff note data over MIDI when the Audition button is pressed.

If Deep Edit is enabled, “Knobs MIDI Out” does not work while in any of the editing menus (Master, Edit, Save/Copy).

**KNOBS/RIFF MIDI OUT**  
don't transmit

*Preset Edit All Layers  
Enable*

This function allows you to turn the Edit All Layers feature on or off. “Edit All Layers” is an Edit menu feature which allows you to select all layers (A) in order to edit all four layers simultaneously. Because this feature can be confusing to the beginning programmer, it can be disabled here in the Master menu. Check this feature out when you’re ready. It’s great!

**PRESET EDIT ALL LAYERS**  
enabled

## Front Panel Knob Calibration

This function calibrates the minimum and maximum values for the five front panel knobs. The controls should be calibrated periodically in order to compensate for normal wear and tear on the controls themselves or if the controls behave strangely. Before calibration, it's usually a good idea to let the unit warm up for about half an hour to ensure you have the maximum range on all the front panel controls.

### ► To Calibrate the Front Panel Control Knobs

1. Press the Master menu button and advance to the Calibrate Knobs page.



CALIBRATE KNOBS  
Start

2. Press the Enter button to begin the calibration process. The following screen appears.

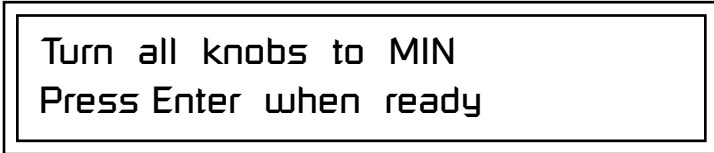

Turn all knobs to MIN  
Press Enter when ready

3. Turn all knobs to their minimum value (which is pegged in the counter-clockwise direction), then press the Enter button. The screen briefly flashes, "Reading Values...", then displays:

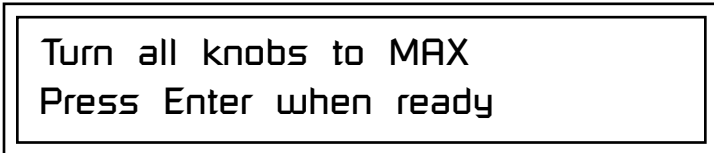

Turn all knobs to MAX  
Press Enter when ready

4. Turn all knobs to their maximum value (pegged in the clockwise position), then press the Enter button. The display shows, "Reading Values... Done." Calibration is complete.

## MIDI SysEx Packet Delay

Sometimes errors occur if the computer or sequencer to which you are sending MIDI SysEx data is faster or slower than the Xtreme Lead. The MIDI SysEx Packet Delay command lets you specify the amount of delay between MIDI SysEx packets so the input buffer of your computer does not overflow, causing an error. The value range is from 0 through 8000 milliseconds. A delay value of zero allows full speed MIDI transfer. If you are experiencing data transmission errors, try increasing the delay value until the problem disappears.

<p><b>MIDI SYSEX PACKET DELAY</b> <b>300 milliseconds</b></p>
---

## Send MIDI System Exclusive Data

This command transmits MIDI System Exclusive (SysEx) data to the MIDI Out port of Xtreme Lead. The MIDI data can be sent to a computer, sequencer or to another Xtreme Lead. When transferring data between two Xtreme Leads be sure both units have the same SysEx ID number! See "MIDI SysEx ID" on page 81 to learn how to change the SysEx ID.

Using the cursor key and the Data Entry Control, select the type of MIDI data you want to transmit. Following are descriptions of the types of MIDI data that can be transmitted.

### Current Multisetup

Transmits all parameters in the Master menu except Tuning Tables, Program/Preset Map and Viewing Angle.

### Program /Preset Map

Transmits the MIDI Program -> Preset Map.

### All User Tuning Tables

Transmits all 12 user User Tuning Tables.

### Multimode Map

Transmits the following parameters:

- Multimode Basic Channel
- Multimode Effects Control Channel
- Multimode Tempo Control Channel

*and for each MIDI Channel...*

- Preset, Volume, & Pan
- Mix Output
- Multimode Channel Enable
- Multimode Bank Map
- Multimode Receive Program Change

 The Preset, Volume, and Pan information for all 16 channels is included when the Multi mode Map settings are transmitted or received.





**WARNING:** When transferring SysEx data from one Xtreme Lead to another, the ID numbers of both units must match.

### **Bank 0 User Presets**

Transmits all the user defined presets in Bank 0.

### **Bank 1 User Presets**

Transmits all the user defined presets in Bank 1.

### **Bank 2 User Presets**

Transmits all the user defined presets in Bank 2.

### **Bank 3 User Presets**

Transmits all the user defined presets in Bank 3.

### **Any Individual Preset**

Transmits only the selected preset.

### **All User Arp Patterns**

Transmits all user arpeggiator patterns.

### **All User Data**

Transmits ALL: user presets, user tuning tables, user arp patterns, and user multisetups.

The Enter LED will be flashing. Press the Enter button to confirm the operation. To receive MIDI data, simply send the MIDI data into Xtreme Lead from another Proteus or from a computer/sequencer.

**SEND MIDI SYSEX DATA**  
**bank 1 user presets**

#### **► To Record MIDI SysEx Data into a Sequencer:**

1. Setup the sequencer to receive system exclusive data.
2. Place the sequencer into record mode, then Send MIDI Data.

#### **► To Receive MIDI SysEx Data from a Sequencer:**

Simply play back the sequence containing the SysEx data into Xtreme Lead.

## User Key Tuning

 The user key tuning can be used to tune individual percussion instruments.

User Key Tuning lets you create and modify 12 user definable tuning tables. The initial frequency of every key can be individually tuned, facilitating the creation of alternate or microtonal scales.

Using the cursor keys and the Data Entry Control, select the user table number, the key name, the coarse tuning and the fine tuning. The key name is variable from C-2 to G8. Coarse Tuning is variable from 0 to 127 semitones. The fine tuning is variable from 00 to 63 in increments of 1/64 of a semitone (approx. 1.56 cents). For each preset, the specific tuning table is selected in the Edit menu.

<b>USER KEY TUNING</b>	<b>Table: 1</b>
<b>Key: C1</b>	<b>Crs: 036</b>
	<b>Fine: 00</b>

## Screen Viewing Angle

This function changes the viewing angle of the display so that you can read it easily from either above or below the unit. The angle is adjustable from +7 to -8. Positive values will make the display easier to read when viewed from above. Negative values make the display easier to read from below.

<b>VIEWING ANGLE</b>
<b>+0</b>

# *Programming Basics*

This chapter explains how Xtreme Lead sounds are constructed and contains important background information on how to create your own custom presets.

Your initial involvement with Xtreme Lead will most likely be using the existing presets and selecting MIDI channels. While the factory presets are very good, there are some things you will probably want to change eventually, perhaps the LFO speed, the filter frequency or the attack time. You may also want to make your own custom presets using complex modulation routings. This module will do far more than you ever imagined and there are whole new classes of sound just waiting to be discovered.

Each preset can consist of up to four instrument layers. Each of the four layers can be placed anywhere on the keyboard and can be crossfaded or switched according to key position, velocity, or by using a real-time control such as a wheel, slider, pedal, LFO or envelope generator. A preset can also be “linked” with up to 2 more presets creating additional layering or splits.

Xtreme Lead has an extensive modulation implementation using two multi-wave LFO's (Low Frequency Oscillators), three multi-stage envelope generators and the ability to respond to multiple MIDI controllers. You can simultaneously route any combination of these control sources to multiple destinations.

There are 512 user locations (USER Banks 0-3) available to store your own creations or edited factory presets. It's easy and fun to edit or create your own unique presets.

## Modulation

To modulate means to dynamically change a parameter, whether it be the volume (amplitude modulation), the pitch (frequency modulation), and so on. Turning the volume control on your home stereo rapidly back and forth is an example of amplitude modulation. To modulate something we need a modulation source and a modulation destination. In this case, the source is your hand turning the knob, and the destination is the volume control. If we had a device that could turn the volume control automatically, we would call that device a modulation source.

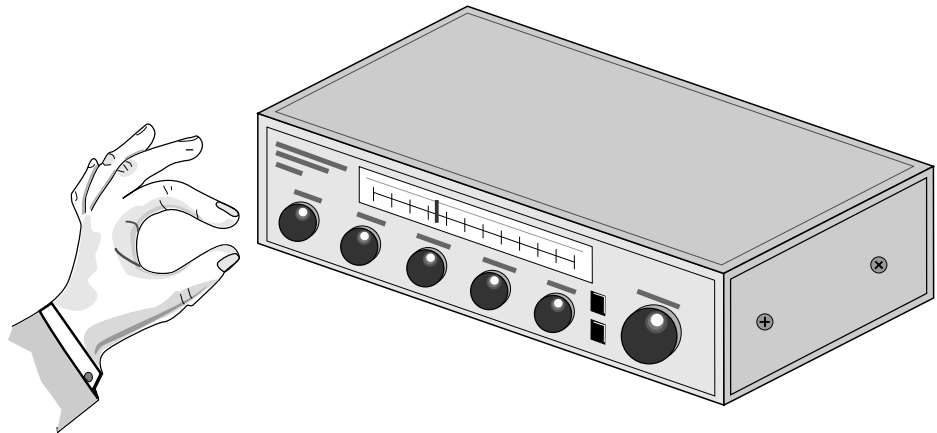

Turning the volume control back and forth on your home stereo is an example of Amplitude Modulation.

Xtreme Lead is designed so that each of the variable parameters, such as the volume, has an initial setting which is changed by a modulation source. Therefore in the case of volume, we have an initial volume that we can change or modulate with a modulation source.

Two main kinds of modulation sources on Xtreme Lead are *Envelope Generators* and *Low Frequency Oscillators*. In the example above, an envelope generator could be routed to automatically turn the volume control as programmed by the envelope. Or, a low frequency oscillator could be routed to turn the volume up and down in a repeating fashion.

Positive modulation adds to the initial amount. Negative modulation subtracts from the initial amount.

### Summing Nodes

All the modulation inputs on Xtreme Lead are summing nodes. This means that you can connect as many modulation sources as you want to an input (such as *Pitch* or *AmpVol*). Modulation sources are simply added algebraically—connecting two knobs one set to -100 and the other set to +100 yields a net value of zero.

## Modulation Sources



**Tip:** Try routing *Key Glide* to *Filter Frequency* if you want the filter to smoothly follow pitch in solo mode. Routing *Key Glide* to *Pan* creates another interesting effect.

Modulation sources include *Envelope Generators*, *Performance Controllers* and *Low Frequency Oscillators*. In the previous example, an envelope generator was routed to automatically turn the volume control as programmed by the envelope, or, a low frequency oscillator could be routed to turn the volume control up and down in a repeating fashion. The following is a list of the modulation sources used in Xtreme Lead.

### **Keyboard Key**

Which key is pressed.

### **Key Velocity**

How fast the key is pressed.

### **Release Velocity**

How fast the key is released.

### **Gate**

High if the key is pressed, low when the key is released.

### **Key Glide**

A smoothly changing control source based on the *Glide Rate* and the interval between the last two notes played.

### **Pitch and Mod Wheels**

Synthesizer pitch bend and modulation wheels.

### **Keyboard Pressure (mono aftertouch)**

Key Pressure applied after the key is initially pressed.

### **Pedal**

A continuously variable pedal controller.

### **Miscellaneous Controllers A -L**

Any type of MIDI continuous controller data.

### **Low Frequency Oscillators (2 per layer)**

Generate repeating waves.

### **Envelope Generators (3 per layer)**

Generate a programmable “contour” which changes over time when a key is pressed.

### **Noise & Random Generators**

Generate spectrums of noise and random signals.

### **Footswitches**

Change a parameter when the switch is pressed.

### **Clock Divisor**

The master tempo clock can be divided and used as a modulation source.

## Random Sources

Random modulation sources can be used when you want the timbre of the sound to be “animated” in a random or non-consistent manner.

- **Key Random 1 & 2** generate different random values for each layer which do not change during the note.
- The **White & Pink Noise** Generators produce varying random values. Both white and pink noise sources are low frequency noise designed for control purposes. Either noise source can be filtered even more by passing it through a lag processor.
- The **Crossfade Random** function generates the same random value for all layers in a preset. This source is designed to be used for cross-fading and cross-switching layers, although you may find other uses.

## Modulation PatchCords

 The controller Knobs assignments printed on the front panel are the system defaults. You can change any of these assignments using the Real-time Controller Assignment page in the Master menu (see page 83 for details).

When setting up modulation with the XL-1, you define a modulation source and a modulation destination. Then, you connect the source to the destination using “PatchCords.” XL-1’s PatchCords are connected in the software. Xtreme Lead has 24 general purpose PatchCords for each layer.

You can connect the modulation sources in almost any possible way to the modulation destinations. You can even modulate other modulators. Each PatchCord also has an amount parameter which determines “how much” modulation is applied to the destination. The modulation amount can be positive or negative. Negative values invert the modulation source.

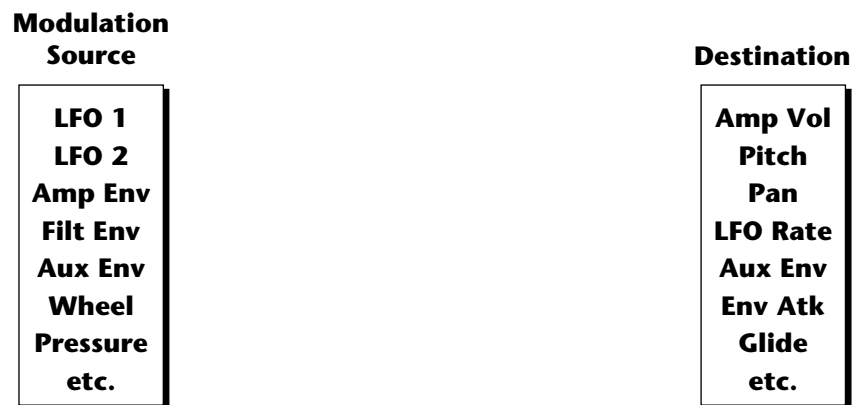
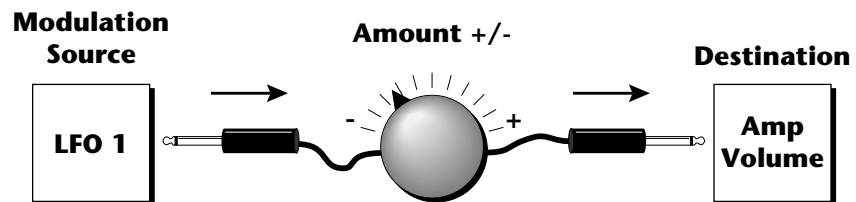

## Envelope Generators



If two adjacent segments have the same level in a "time-based" envelope, the segment will be skipped. Adjacent segments must have different levels for the rate control to work.

An envelope can be described as a "contour" which is used to shape the sound over time in a pre-programmed manner. There are three envelope generators per layer and all of them are the rate/level type.

This is how the rate/level (*time based*) envelopes work: When a key is pressed, envelope starts from zero and moves toward the Attack 1 Level at the Attack 1 Rate. As soon as it reaches this first level, it immediately begins the next phase and moves toward the Attack 2 level at the Attack 2 rate. As long as the key is held down, the envelope continues on through the Decay 1 and Decay 2 stages. If the key is still held when the envelope reaches the end of Decay 2, it simply waits there for you to release the key. When you release the key, the envelope continues into the Release 1 and Release 2 stages, stopping at the end of the Release 2 stage. XL-1's envelope generators provide great flexibility for programming both complex and simple envelopes.

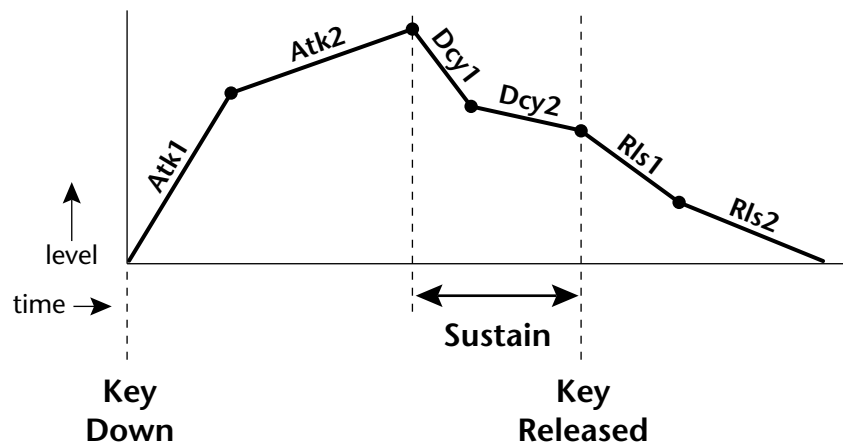

All three envelope generators have the six stages described above. The Volume Envelope generator controls the volume of the voice over time. The Filter Envelope generator is a general purpose envelope most often used to control the filter frequency. Unlike the Volume Envelope, however, the Filter Envelope can have a negative level value as well as a positive level. There is also an Auxiliary Envelope generator which is a general purpose envelope. The Auxiliary Envelope is identical to the Filter Envelope and can have negative as well as positive levels. You can adjust the time of each stage to create myriad envelope shapes, which in turn shape the sound over time.



By routing the Auxiliary or Filter Envelopes to control the pitch (PatchCords) you can easily hear the shape of the envelopes you are creating.

- Volume envelopes contour the way the volume of a sound changes over time determining how we perceive that sound. For example, a bell struck with a hammer is instantly at full volume, then slowly dies away. A bowed violin sound fades in more slowly and dies away slowly. Using Xtreme Lead's Volume Envelope, you can simulate the different types of natural instrument volume envelopes by programming them appropriately.

### Tempo-based Envelopes

Tempo-based envelopes are based on *Time* which is controlled by the Master Tempo (*located in the Master menu*). The Master Tempo rate scales the time of the Tempo-based envelope segments. The Master Tempo can also be set to use an external MIDI clock so that the envelope times can be synchronized to external sequencer or arpeggiator tempo changes.

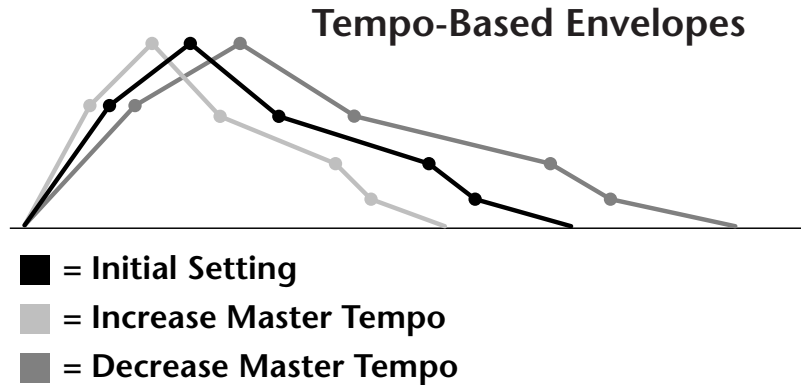

### Envelope Repeat

The Envelope Generators can also be made to repeat. When the envelope repeat function is On, the Attack (1&2) and Decay (1&2) stages will continue to repeat as long as the key is held. As soon as the key is released, the envelope continues through its normal Release stages (1 & 2).

 Only the Filter and Auxiliary Envelopes have the repeating feature.

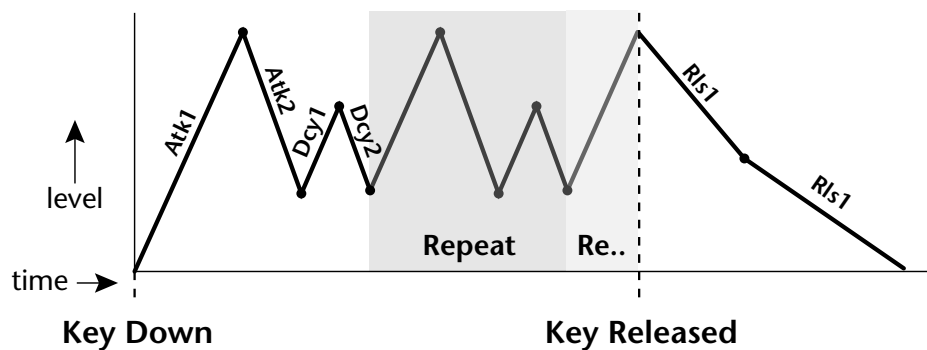

The diagram above show how the looping envelopes work. When the key is pressed the envelope goes through its regular Attack 1, Attack 2, Decay 1 and Decay 2 stages. In non-looping mode, the envelope would hold at the end of the Decay 2 stage until the key was released. In looping mode however, it jumps back to the Attack 1 stage and repeats the first four stages. It continues to loop through these four stages until the key is released where it immediately jumps to the Release 1 stage.



# Low Frequency Oscillators (LFOs)

## LFO Tricks & Tips:

- The Random LFO wave is truly random and is different for each voice and layer.
- The Pattern (Pat) waveforms will sound the same on different layers and voices.
- Sine + Noise is very useful for simulating trumpet and flute vibrato.

### ★ When routing Hemi-quaver to Pitch:

- +38 = major scale
- 38 = phrygian scale
- +76 = whole tone scale
- (+38) + (+76) = diminished (two cords)
- odd amount = S+H sound

**Note:** References to musical intervals in the pattern LFO shapes are with the LFO routed to pitch and a PatchCord amount of +38.

 Try combining the Pattern LFOs, or controlling the amount of one with another, or combining them with the clock divisors.

A Low Frequency Oscillator or LFO is simply a wave which repeats at a slow rate. The Xtreme Lead has two multi-wave LFOs for each channel. The LFO waveforms are shown in the following illustration.

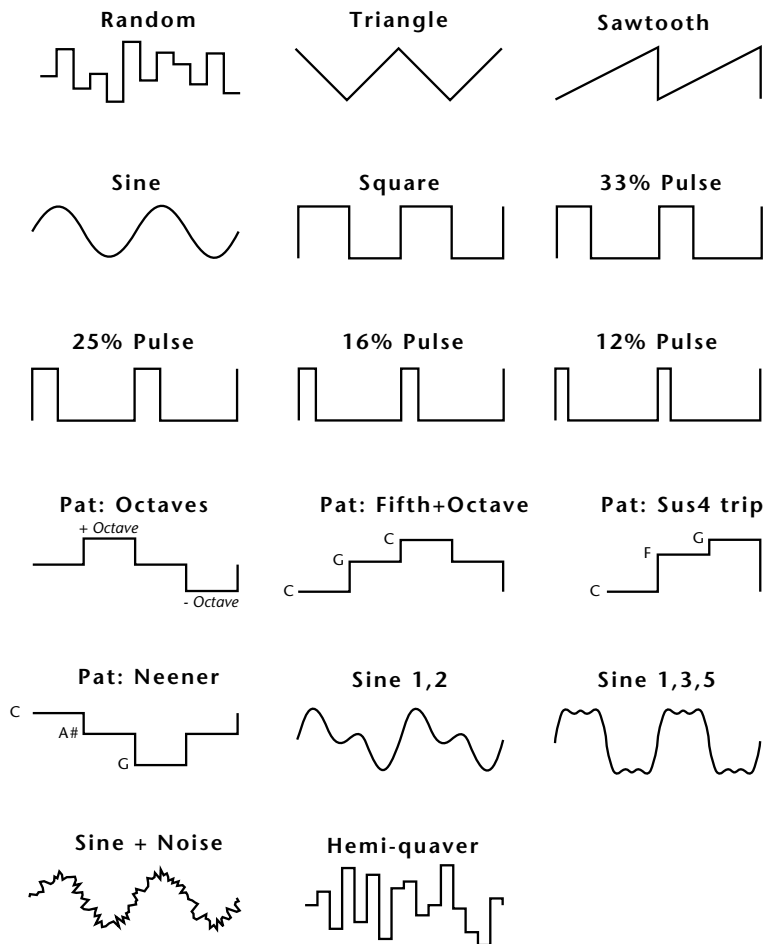

By examining the diagram of the LFO waveforms, you can see how an LFO affects a modulation destination. The shape of the waveform determines the result. Suppose we are modulating the pitch of an instrument. The sine wave looks smooth, and changes the pitch smoothly. The square wave changes abruptly and abruptly changes from one pitch to another. The sawtooth wave increases smoothly, then changes back abruptly. The sound's pitch follows the same course. Controlling the pitch of an instrument is an easy way to hear the effects of the LFO waves.

Like the Auxiliary Envelope, LFOs can be routed to control any real-time function such as Pitch, Filter, Panning, or Volume. A common use for the LFO is to control the pitch of the sound (LFO -> Pitch). This effect is called vibrato and is an important performance effect. Many presets use this routing with the modulation wheel controlling "how much" LFO modulation is applied. Another common effect, Tremolo, is created by controlling the volume of a sound with the LFO (LFO -> Volume).

You might use the LFOs to add a slight bit of animation to the sound by routing the LFO to control the filter. For this effect, set the LFO “amount” low for a subtle effect.

When a PatchCord amount is a negative value, the LFO shape is inverted. For example, inverting the sawtooth wave produces a wave that increases abruptly, then smoothly glides down.

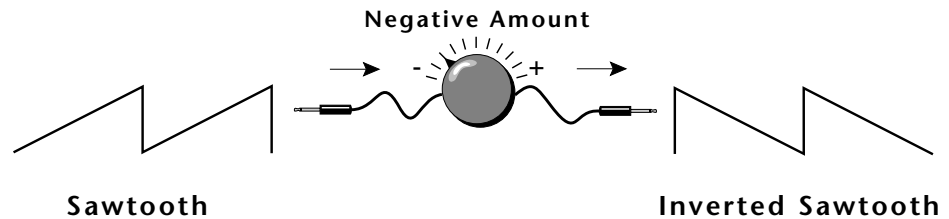

## Clock Modulation

 Envelopes are triggered on the positive going edge of the clock. LFOs are triggered on the negative going edge of the clock.

 The tempo of the master clock is set in the Master menu.

You can use the Master Clock as a modulation source, to trigger the Filter or Auxiliary Envelope generators, trigger Sample Start, synchronize the LFOs, or directly as a square wave modulation source. The Clock source is available in eight divisions (octal whole note, quad whole note, double whole note, whole note, half note, quarter note, eighth note, sixteenth note). You can use the different rates separately or in conjunction to create complex “synchro-sonic” rhythm patterns. You can also use a MIDI Clock as the Master Clock to synchronize to an external MIDI device such as a drum machine or sequencer. (See *Master Tempo* in the *Master* menu.)

Clocks are routed exactly like the other modulations sources using the PatchCords. The PatchCord Amount MUST be positive (+) for the clock to pass. By modulating the PatchCord Amount, you can route the divided clocks using real-time controllers or other modulation sources.

When an LFO is triggered by a clock, the LFO wave resets to zero every time the clock wave goes low. If the LFO rate is close to the clock rate, the LFO virtually synchronizes with the clock. If the two rates are far apart, the waveform of the LFO will be mildly or radically altered.

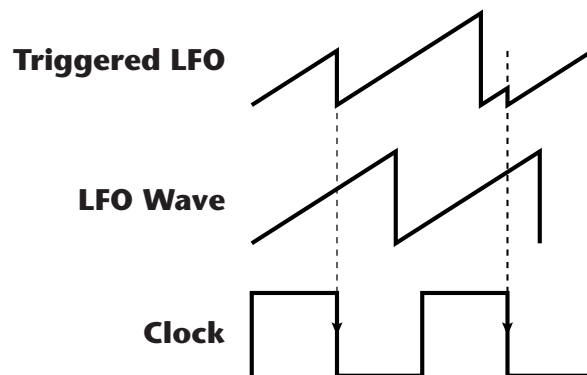

LFO Trigger causes the LFO to reset each time the clock waveform goes low.



LFO Synced to 1/4 Note Clock

LFOs can also be perfectly synchronized with the clock at any of 25 note divisions. This allows you to create very cool “synchro-sonic” effects that work perfectly at any tempo. Choosing one of the note divisors in the LFO rate screen selects the synced LFO function.

There are many possibilities for clock modulation and retrigger. For example, you can create a repeating six segment curve of any shape by triggering the Filter or Auxiliary Envelope generators with the clock. A few other possibilities are listed below.

- Turn different voice layers on and off using different clock divisors.
- Switch between Auxiliary and Filter Envelope retriggering using a slider or footswitch.
- Retrigger LFOs or Envelopes using noise or other LFOs to create random or semi random effects.
- Alter the LFO waveform by modulating the rate of a triggered LFO.
- Route multiple clocks with different divisors to the same destination (such as pitch) to create complex patterns. (*Hint: Adjust the PatchCord Amounts.*)

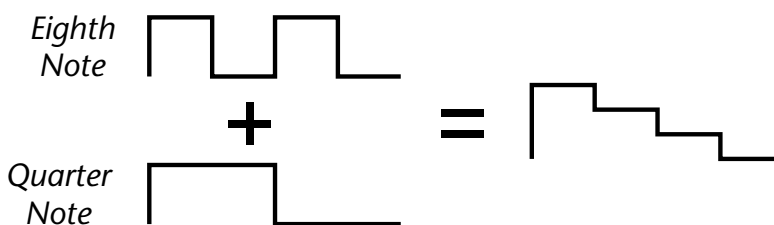

Adding these two clocks together in equal amounts produces a stairstep waveform.

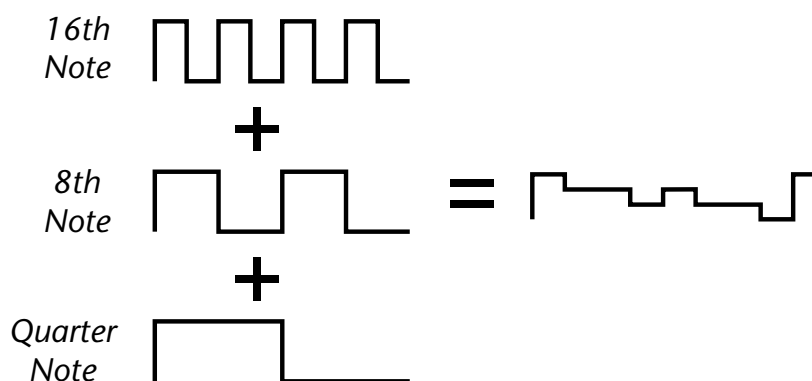

Adding multiple clocks with unequal amounts produces complex repeating patterns.

# Modulation Destinations

The PatchCords section of the Edit menu is where you connect sources to destinations. Each PatchCord has an amount associated with it which controls how much modulation is applied.

L1	PATCHCORD	#01
	ModWhl ->	RTXfade +036

The PatchCords screen above and the diagram below show how modulation sources are connected to destinations. The modulation sources can control any of the destinations in the layer.

 All the modulation destinations are summing nodes. This means that you can connect as many modulation sources as you want to a destination. Modulation sources are simply added algebraically — connecting two sources, one with a value of -100 and the other with a value of +100 yields a net value of zero.

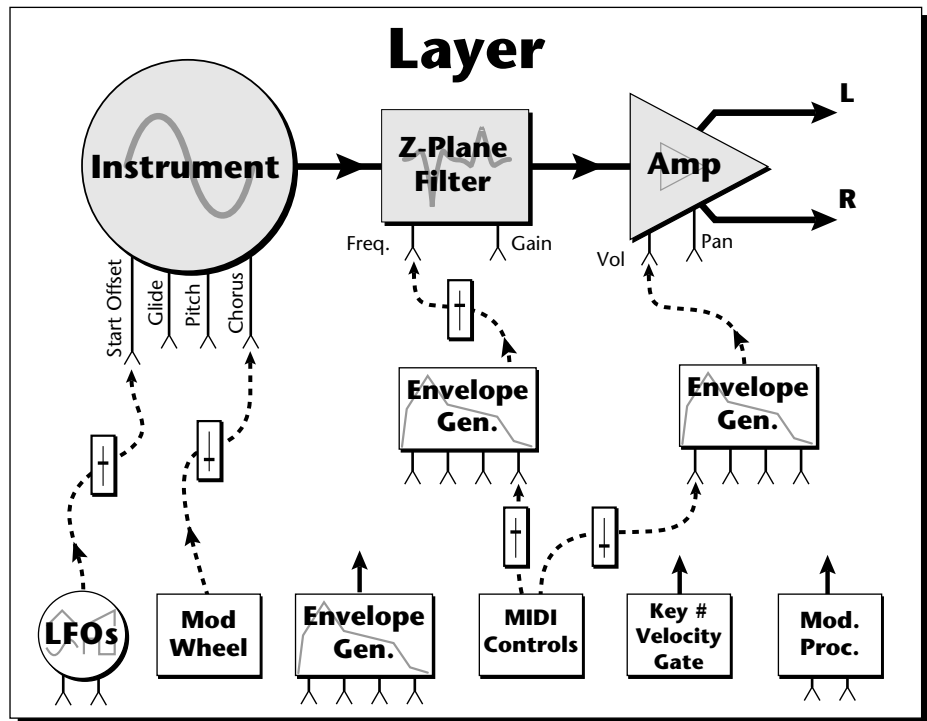

- Note-on modulation sources, such as key, velocity and gate output a single value at note-on time. Realtime modulation sources such as LFOs, envelope generators and modulation wheels output continuously changing values.

The possible modulation routings are completely flexible as shown in the diagram above. Multiple sources can control the same destination, or a single source can control multiple destinations.

## Modulation Processors

Modulation processors are devices which can modify modulation sources such as LFOs and envelope generators before they are applied to a destination. Modulation processors let you create patches and do tricks which would not be possible otherwise. These modulation processors are independently programmable on each of the four layers.

### Switch

Outputs a digital “1” when the input is greater than “0”.

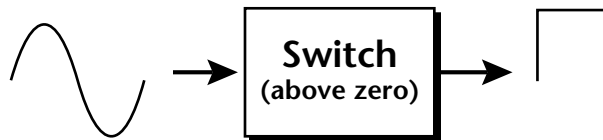

### Summing Amp

Lets you add several modulation signals together before applying them to a destination. This processor can save PatchCords when routing the output to multiple destinations.

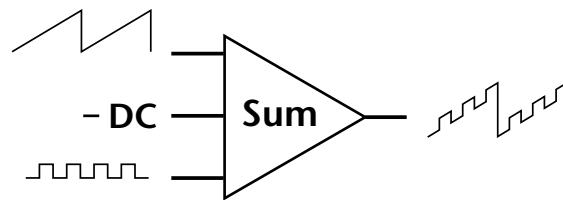

### Lag Processors

Slows down rapid changes in the input signal. The output “lags” behind the input at a pre-programmed rate. There are two lag processors, Lag 0 and Lag 1. Lag 1 has a longer lag time than Lag 0.



### Absolute Value

This function inverts negative input values and outputs only positive values. This device is also called a full wave rectifier.

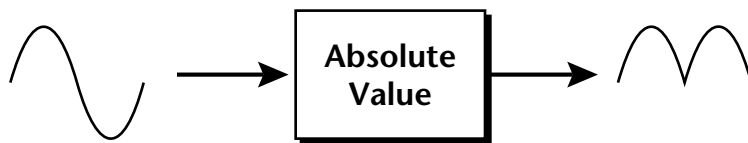

### Diode

The diode blocks negative input values, passing only positive values.

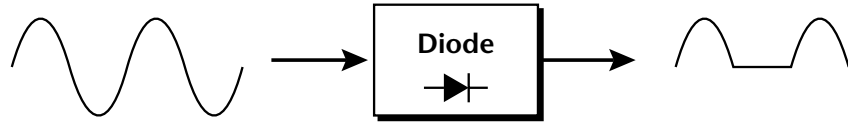

### Flip-Flop

The output of this processor alternates between a digital "1" and digital "0" each time the input goes positive from zero or a negative value. With an LFO input, the output will be a square wave of half the input frequency.



 The value of a digital "1" is equal to the PatchCord amount.

### Quantizer

With the input PatchCord set to 100%, the output value is limited to 16 discrete values. The value of the input PatchCord controls the number of steps. The value of the output PatchCord controls the size of the steps.

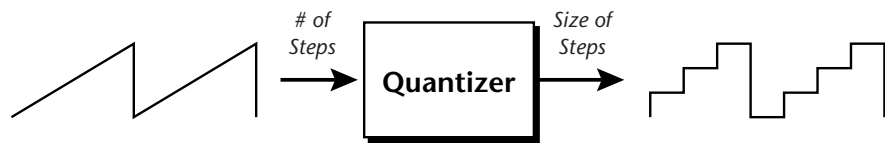

### 4x Gain

This processor amplifies the modulation source by a factor of 4.

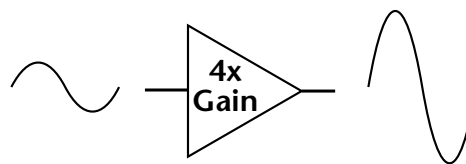

 Summing Amps can be useful in complicated patches where you want to control a combination of modulation signals with a single patchcord.

### Lag Inputs

The Lag processors can be used as 2 additional summing amps. Lag0sum and Lag1sum are modulation sources which equal the sum of PatchCords connected to the Lag in destination. The summing amp is located before the lag processor as shown in the following illustration.

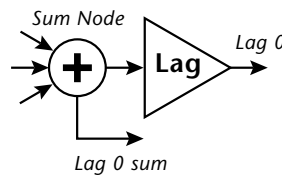

# Preset Modulation Processors

 *Preset Modulation Processors start working as soon as the preset is selected. The Layer Modulation Processors take effect only when a key is pressed.*

There are also two “Preset Level” modulation processors located in the “Preset Patchcords” screen of the Edit menu. It is important to understand that although the preset processors *originate* at the *Preset Level PatchCords*, their output is used in the *Layer PatchCords*.

## Preset Lag

Like the Layer Lag processors (*described on page 101*) the Preset Lag slows down rapid changes in the input signal. The output “lags” behind the input at a pre-programmed rate. Unlike the layer level lag processors, the *preset lag* takes effect as soon as the preset is selected. In contrast, the layer level lag processors begin acting only after a keyboard key has been depressed. The Preset Lag also has a *Lag Amount* input which controls the lag time. Positive lag amounts increase the lag time. A MIDI controller (*front panel knob*) is commonly used to control lag amount.

The preset lag is often used to “spin-up” and “spin-down” an LFO which controls some other effect, perhaps left/right panning, pitch, or the filter. A MIDI footswitch could be used as the input to the lag which acts to slow down the instantaneous change of the switch. The slowly changing output value is then routed using a layer patchcord to crossfade between layers or change the speed of an LFO.

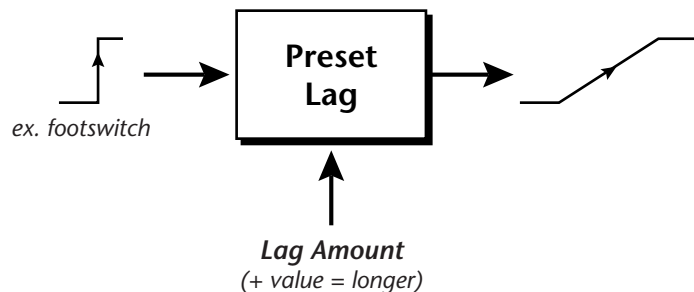

## Preset Ramp

This processor generates a positive or negative going slope whenever the **first** key is depressed on the MIDI channel.

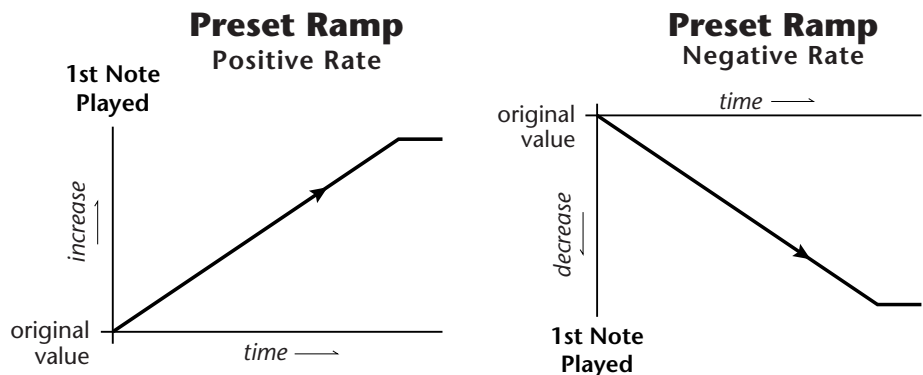

The preset ramp instantly resets when all notes have been released and the next *first key* on the MIDI channel is pressed. The Ramp Rate polarity (+ or -) determines if the ramp will be positive or negative going. The value of the ramp rate sets the increment. Large values produce fast ramps and small values produce slow ramps. Multiple inputs can be connected to the ramp rate (just like all the other destinations in Xtreme Lead).

The patch below shows an application for the Preset Ramp which generates an adjustable decay envelope ONLY on the first note played to bring in the sound from another layer. Instead of routing the output to the Amp Volume you could just as easily route it to control Pitch, LFO Speed or any other destination you can think of. Study this patch if you want to learn a few new tricks using the patchcords.

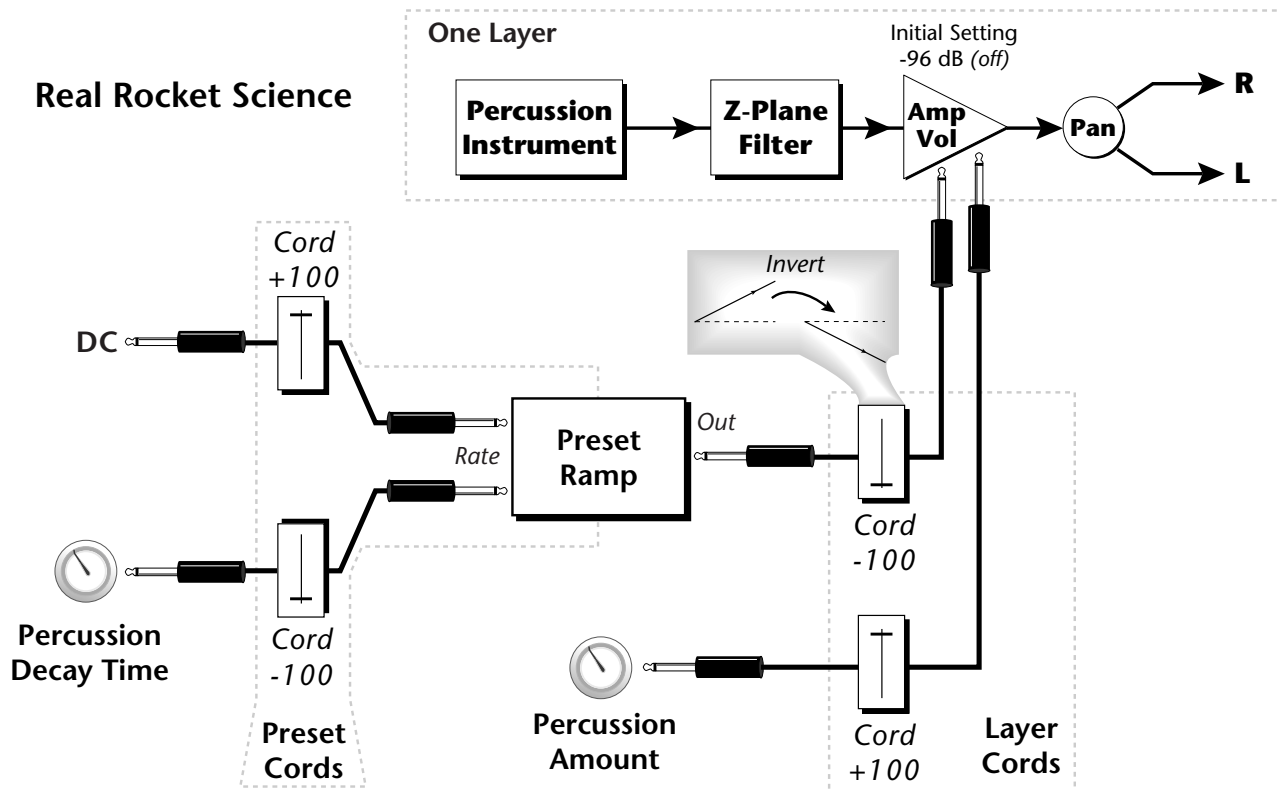

 The combination of the DC & Perc. Decay Time Cords has the effect of reversing the Percussion Decay Time knob. The decay time increases as the knob is turned up.

1. DC - Sets initial ramp Fast-Positive (+100)
2. Decay Knob - Inverted value slows ramp as the knob value is increased.
3. Ramp Out Cord - Inverts Ramp slope (downward).
4. Amp Vol - Initial setting is Off (-96dB). Ramp cannot overcome this negative bias.
5. Perc. Amt - When this knob is turned up, the positive bias on the Amp is restored so that so that the Ramp can now affect Amp Volume.
6. Volume Envelope - Fast Attack, Full Sustain, No Release



## Using the Modulation Processors

Modulation processors are inserted into a modulation routing as shown in the following diagram.

The modular analog synthesizers of yesteryear were incredibly flexible, partly because processing devices could be connected in any order. Modulation processors are designed according to this modular concept. They can be linked and used in a wide variety of ways limited only by your imagination. Consider the following example:

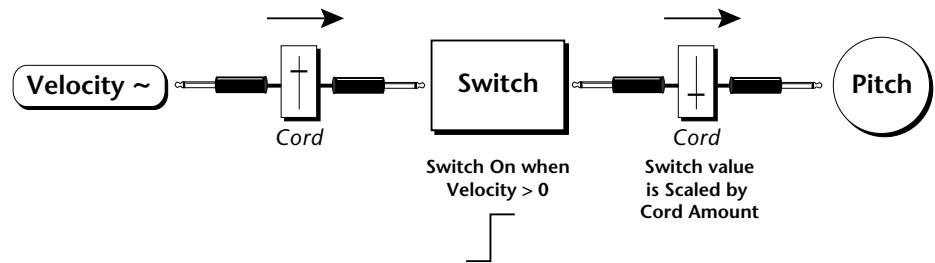

The patch illustrated above is programmed by setting the PatchCord screens as shown below.



This particular modulation shifts the overall pitch up a fifth when the key velocity exceeds 64. Velocities below 64 play at normal pitch. Notes with velocities of 64 and above are raised a perfect fifth. The Velocity “~” source scales the played velocity around zero. In other words, low velocities (below 64) will have negative values and high velocities (64 and above) will be positive. A velocity of 64 would be zero. The Switch module only outputs a “1” if the input value is greater than zero. This digital “1” value can be scaled through the attenuator on the PatchCord to raise or lower the pitch by any amount. In this case, a scaling value of +22 raises the pitch by a perfect fifth. The amount of the PatchCord on the input to the switch is unimportant because ANY velocity value equal or greater than 64 will flip the switch. If the input PatchCord amount were a negative value however, the action of the velocity would be reversed and velocities less than 64 would raise the pitch and velocities equal or greater than 64 would play the original pitch.

But what if you want the velocity switch point to be something other than 64? Thanks to modulation processors, it can be done. Here's how.

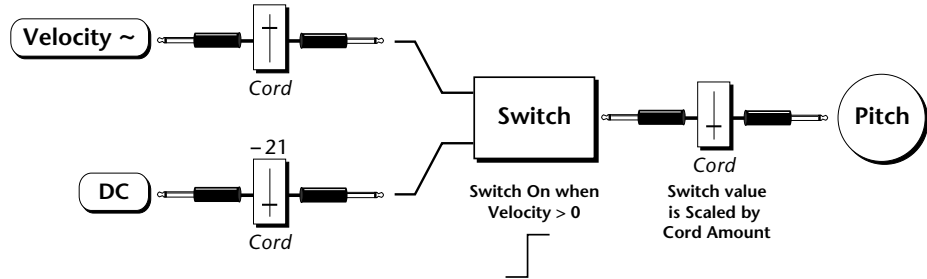

Connect the DC level to the input of the switch along with the velocity value. Note that more than one modulation source can be applied to the input of a processor.

DC offset adds a fixed value based on the PatchCord Amount setting. If applied to the switch along with the velocity, it changes the velocity value required to trip the switch. By setting the DC amount to a negative amount, higher velocity values are required to trip the switch. Setting the DC value to a positive value would bring the velocity switch point down. The PatchCord screens for this patch are shown below.

L1 PATCHCORD	#01
Vel+- -> Switch	+100

L1 PATCHCORD	#02
DC -> Switch	-021

L1 PATCHCORD	#03
Switch -> Pitch	+022

### More Examples

To derive a smooth random function you could route the Pink Noise generator through one of the Lag Processors. A smooth random wave is useful in small amounts to add a degree of natural variation to timbre when routed to filter cutoff. Normal pink noise is low pass filtered audio frequency noise with a 3 dB/octave slope to give equal energy per octave. Xtreme Lead pink noise is actually more like very low frequency filtered noise, but it is perfect for use as a random control source.

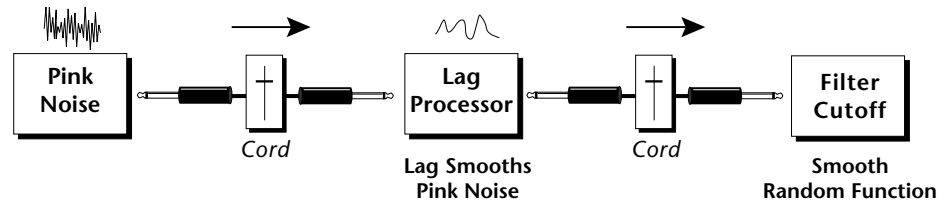

The **Quantizer** can generate interesting whole-tone scales when envelope generators or LFOs are routed to the input. The quantizer turns a smoothly changing input signal into a series of steps. By routing the output of the quantizer to Pitch and adjusting the PatchCord amounts, you can control both the number of steps and the pitch interval of each step.

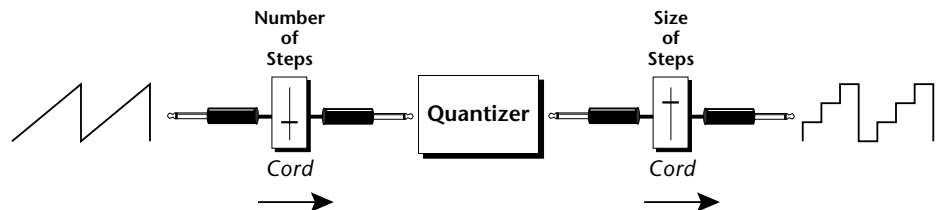



The input PatchCord amount controls how many steps will be generated. With a sawtooth wave (LFO+) feeding the input and the PatchCord amount set to 100%, sixteen steps are generated. The output PatchCord amount controls the size (or interval) of the steps.

Try setting up the following patch exactly as shown below using your favorite preset as a starting point.

L1	LFO1	SHAPE	SYNC
		sawtooth	key sync

L1	LFO1	RATE	DELAY	VAR
		0.35Hz	000	000

 The 4x Amp can be used to get more steps or increase the interval of the Quantizer.

 Experiment with this patch by connecting other sources and destinations to the Quantizer.

L1	PATCHCORD	#01
LFO1+	-> Quantize	+030

L1	PATCHCORD	#02
Quantize	-> Pitch	+100

L1	PATCHCORD	#03
DC	-> Pitch	-050

This patch generates an ascending arpeggio every time a key is pressed. A diagram of the patch is shown below. The patch is very straightforward except for the DC offset which was added to bring the pitch down into tune. (Sometimes you have to fix a problem, but using the mod processors there's usually a way around it to achieve the desired result.)

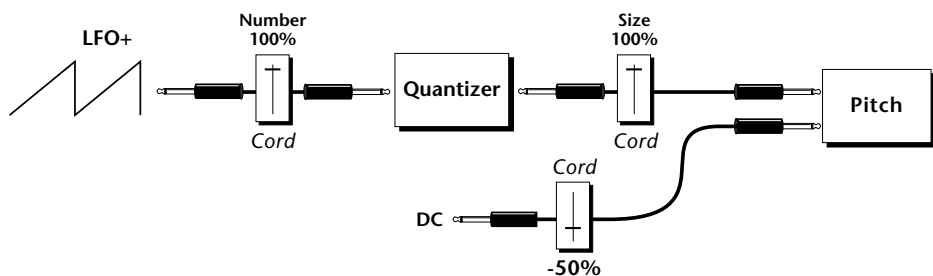

You can start to see some of the possibilities (and there are many). Whenever you find yourself wishing for some esoteric type of control, take a minute to think and see if there is a way to achieve the desired result using the modulation processors.

## Dynamic Filters

The block diagram of the Xtreme Lead's signal path is shown below.

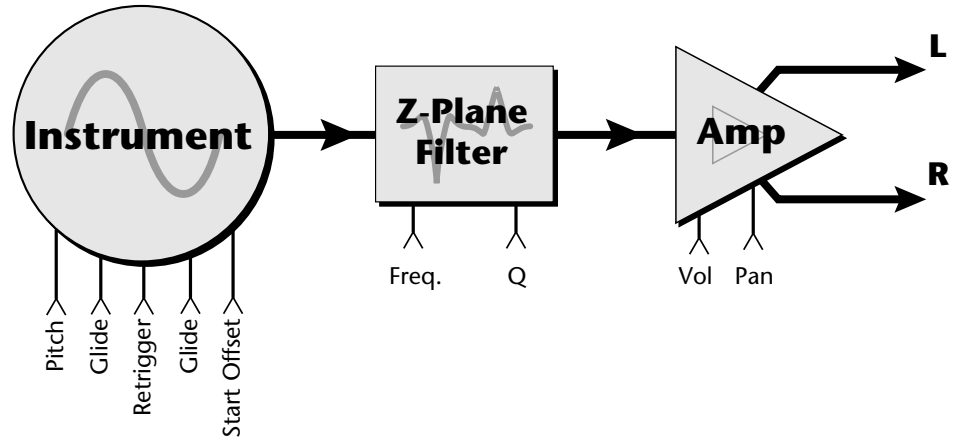

To understand how a filter works, we need to understand what makes up a sound wave. A sine wave is the simplest form of sound wave. Any waveform, except a sine wave, can be analyzed as a mix of sine waves at specific frequencies and amplitudes.

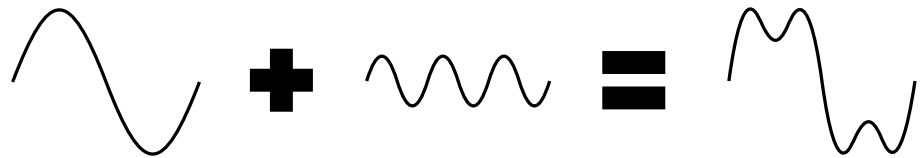

Any waveform can be analyzed as a mixture of sine waves.

One way to represent complex waveforms is to use a chart with frequency on one axis and amplitude on the other. Each vertical line of the chart represents one sine wave at a specific amplitude and frequency.

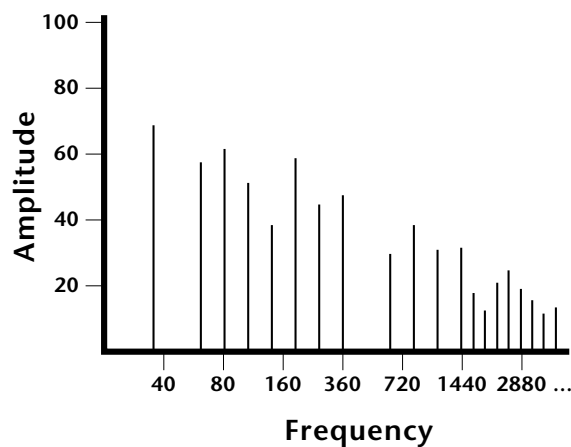

## What is a Filter?

Most sounds are complex waves containing many sine waves of various amplitudes and frequencies. A **filter** is a device which allows us to **remove certain components of a sound depending on its frequency**. For example, a *low-pass filter* lets the low frequencies pass and removes only the high frequencies as illustrated in the following diagram.

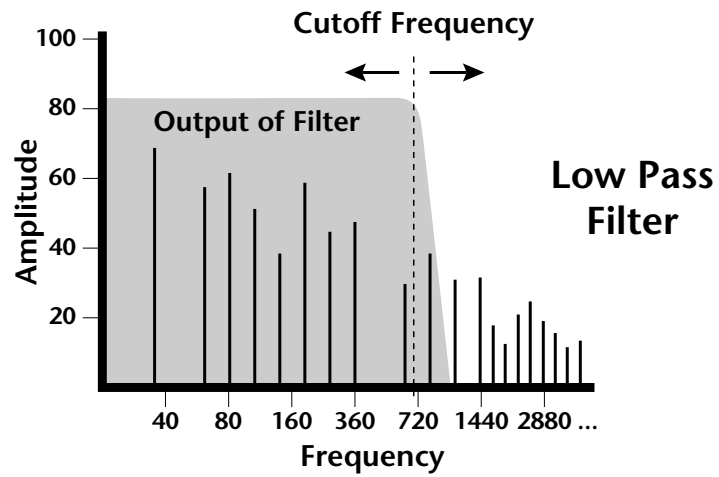

A filter that lets only the high frequencies pass is called a *high-pass filter* as illustrated in the following diagram.

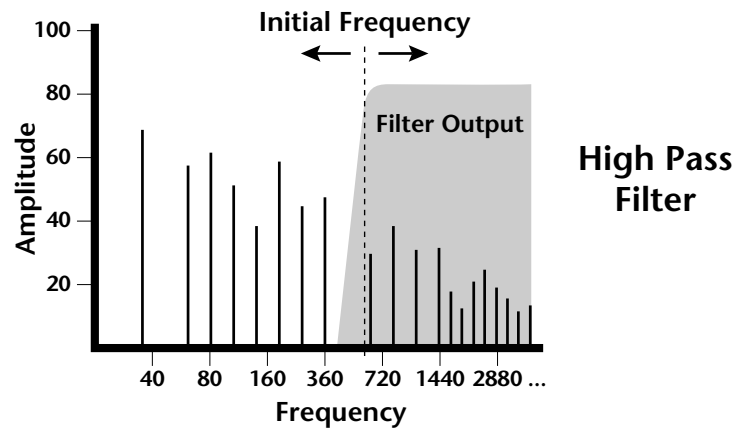

A filter which only lets a certain band of frequencies pass is called a *band-pass filter*.

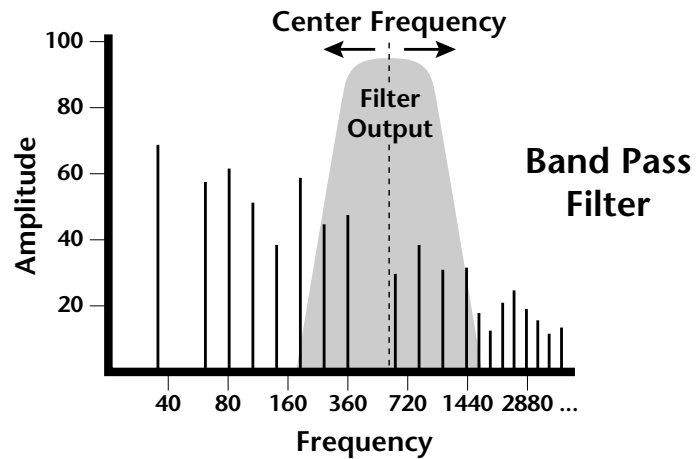

A *notch filter* is just the opposite of a band-pass filter and is used to eliminate a narrow band of frequencies.

Another control found on traditional filters is called Q or resonance. A lowpass filter with a high Q emphasizes the frequencies around the cutoff frequency. The following chart shows how different amounts of Q affect the low-pass filter response. In terms of sound, frequencies around the cutoff tend to “ring” with high Q settings. If a filter with high Q is slowly swept back and forth, various overtones are “picked out” of the sound and amplified as the resonant peak sweeps over them. Bells and gongs are real world examples of sounds which have a high Q.

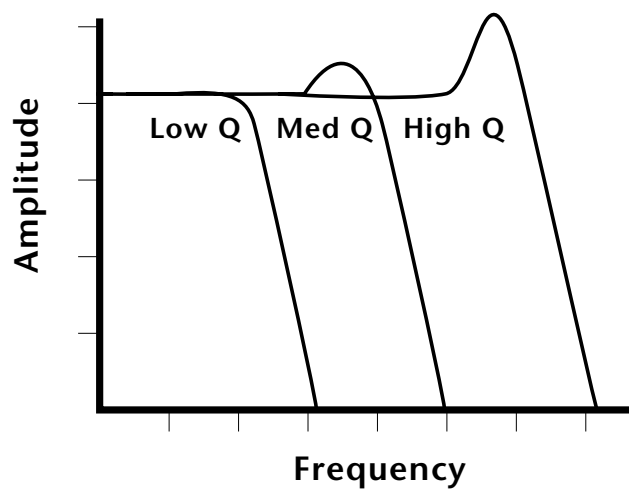

Another characteristic of a filter is the number of poles it contains. Traditional synthesizer filters were usually either 2-pole or 4-pole filters. The Xtreme Lead has selectable 2, 4, and 6-pole low-pass filters. The number of poles in a filter describes the steepness of its slope. The more poles, the steeper the filter's slope and the stronger the filtering action. The tone controls on your home stereo are probably one-pole or two-pole filters. Parametric equalizers are usually either two-pole or three-pole filters.

In terms of vintage synthesizers, Moog and ARP synthesizers used 4-pole filters, Oberheim and E-mu synthesizers were famous for their 2-pole filter sound.

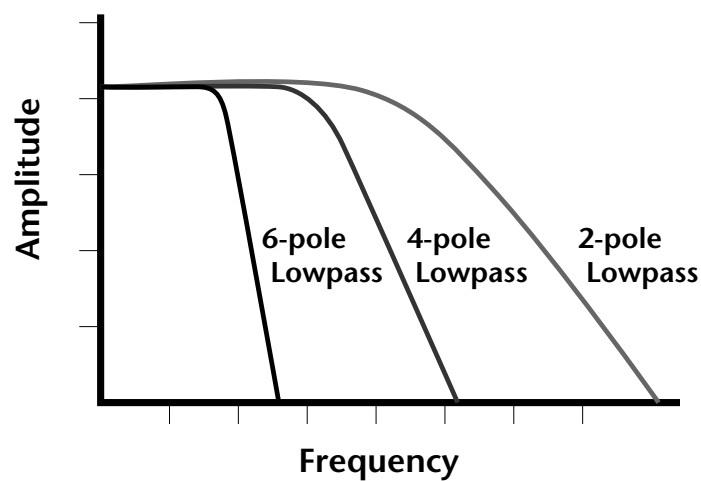

Using a filter, we have a way to control the harmonic content of a sound. As it turns out, even a simple low-pass filter can simulate the response of many natural sounds.

For example, when a piano string is struck by its hammer, there are initially a lot of high frequencies present. If the same note is played softer, there are fewer high frequencies generated by the string. We can simulate this effect by routing keyboard velocity to control the low-pass filter. The result is expressive, natural control over the sound.

If you use an envelope generator to control the cutoff frequency of a filter, the frequency content can be varied dynamically over the course of the note. This adds animation to the sound as well as simulates the response of many natural instruments.



## Parametric Filters

A more complex type of filter is called a parametric filter or *Swept EQ*. A parametric filter allows control over three basic parameters of the filter. The three parameters are: *Bandwidth*, *Frequency* and *Gain*. The Bandwidth allows you to select the width of the range of frequencies to be boosted or cut, the Frequency defines the center frequency of the bandwidth, and the Gain parameter either boosts or cuts the frequencies within the selected band by a specified amount. Frequencies not included in the selected band are left unaltered. This is different from a band-pass filter which attenuates (reduces) frequencies outside the selected band.

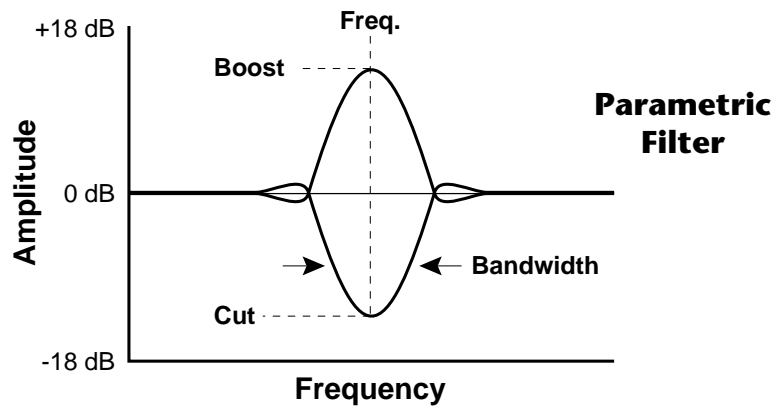

The parametric filter is quite flexible. Any range of frequencies can be either amplified or attenuated. Several parametric sections are often cascaded in order to create complex filter response curves.

If four parametric filter sections were cascaded, it would be possible to create the following complex filter response.

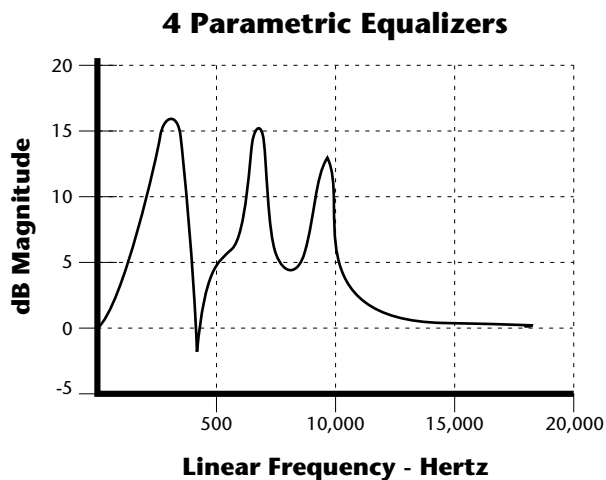

Many natural instruments have complex resonances which are based on their soundboard or tube size. The resonance shown above would be impossible to create using a normal synthesizer filter.

## The Z-Plane Filter

A Z-plane filter is a filter which can change its function over time. In a Z-plane filter, we start with two complex filter types and interpolate between them using a single parameter. See the following diagram.

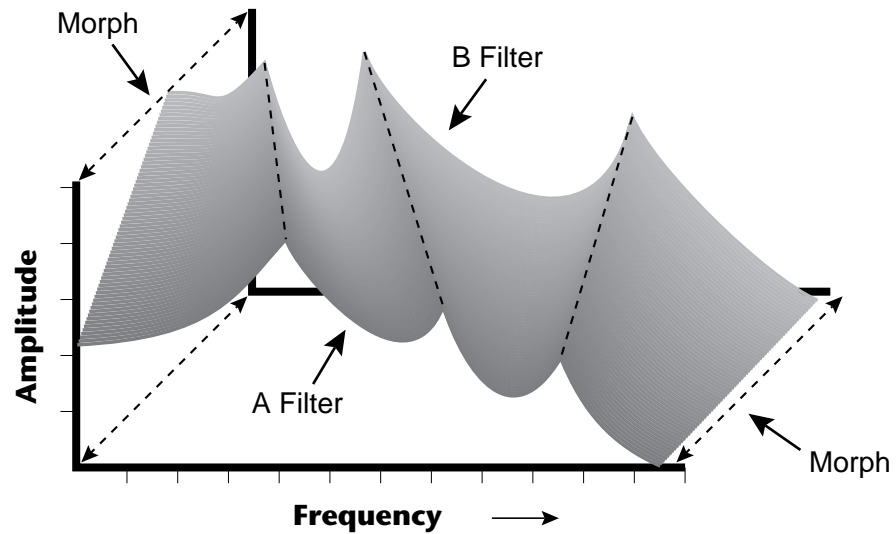

The Z-plane filter has the unique ability to change its function over time.

Filters A and B represent two different complex filters or “frames.” Changing a single parameter, the Morph, changes many complex filter parameters simultaneously. Following along the Morph axis you can see that the filter response smoothly interpolates between the two filters. This is the essence of the Z-plane filter. Through the use of interpolation, many complex parameters are condensed into one manageable entity.

Consider, as an example, the human vocal tract, which is a type of complex filter or resonator. There are dozens of different muscles controlling the shape of the vocal tract. When speaking, however, we don't think of the muscles, we just remember how it feels to form the vowels. A vowel is really a configuration of many muscles, but we consider it a single object. In changing from one vowel to another, we don't need to consider the frequencies of the resonant peaks. You remember the shape of your mouth for each sound and interpolate between them.

This Z-plane filter sweep can be controlled by an envelope generator, an LFO, modulation wheels or pedals, keyboard velocity, key pressure, and so on. In fact, any of the modulation sources can control the Z-plane filter.

Because creating the complex filtering is difficult and very time consuming, we have created 50 different filters and installed them permanently in ROM for your use. You simply select and use the filters in a manner similar to choosing an instrument. Because there are so many types of instruments and filters to choose from, the number of possible permutations is staggering.

## Signal Flow

Going back to the Signal Path diagram for a single channel we can reexamine the complete signal path.

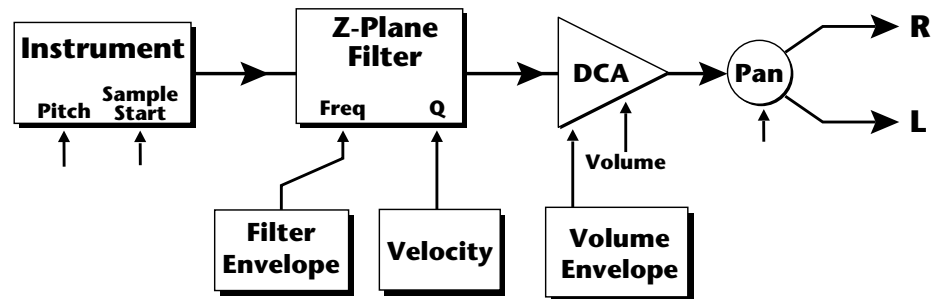

### Instrument

This is the sampled sound wave. The pitch of the instrument can be modulated by any modulation source. The sample start point can be changed only at the time the note is played.

### Z-Plane Filter

The Z-Plane Filter is used to shape the harmonic content of an instrument. The filter envelope is commonly used to shape the harmonic content dynamically over time but the filter frequency can be modulated by any source. The Q parameter can be modulated only at note-on time. There are 50 types of filters available. See “Xtreme Lead Filter Types” on page 141 for a complete list of the filters.

### Digitally Controlled Amplifier (DCA)

Together with the Volume Envelope, the DCA is used to shape the volume contour of a sound. The DCA can be controlled by any modulation source. Velocity is often used as a modulation source for the DCA so that the harder you play, the louder the sound becomes.

### Pan

Adjusts the balance of sound to the left and right channels. Pan can be modulated by any modulation source.

## MIDI Channels & Real-time Controls

The MIDI real-time controllers may seem confusing at first, but they are really very simple once you understand them. You already know that there are 16 MIDI channels per MIDI cable. Each MIDI channel uses three basic types of messages; note on/off, preset changes, and continuous controller messages. Your MIDI keyboard, in addition to telling Xtreme Lead which note was played, can also send real-time control information, which simply means control occurring in real-time or "live." (You may be using a MIDI device other than a keyboard, but for simplicity's sake we'll presume that you are using a keyboard.) Real-time control sources include such things as pitch wheels or levers, modulation wheels or levers, control pedals and aftertouch and are used to add more expression or control.

Your MIDI keyboard sends out real-time controller information on separate continuous controller numbers. There is a set of 32 continuous controller numbers for each MIDI channel. Some of the controllers, such as the modulation wheel, volume, and pan have standardized numbers. For example, volume is usually sent on continuous controller #7. Your keyboard may have other real-time controls such as a control pedal or data sliders which can also be programmed to control the Xtreme Lead.



The following MIDI controls are automatically routed in Xtreme Lead:

Pitch Wheel	pwh
Modulation Wheel	01
Old DX7 Aftertouch	03
Pedal	04
Volume	07
Pan	10

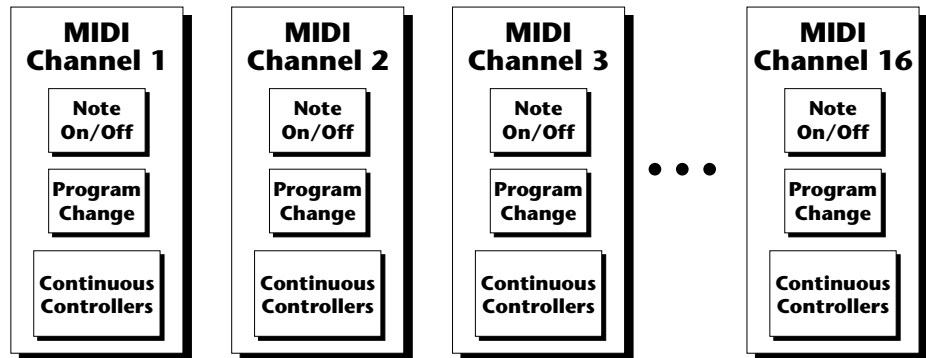

Any MIDI controller can be routed to any modulation destination. First, you have to know which controller numbers your keyboard transmits. Most modern MIDI keyboards let you select a controller number for each control on the keyboard. For example, it may let you select a number from 0-31 for the data slider. The realtime controller numbers that the keyboard transmits must match the numbers Xtreme Lead is receiving, otherwise nothing will happen when you move the controls.

Suppose you wanted to send the four data sliders on your master keyboard. Proteus can handle 12 MIDI controllers (A-L) of your choosing. "MIDI A-L" are simply names for the internal connections that link external MIDI continuous controllers to the PatchCord section of Proteus. There are two parts to the connection. First, MIDI controller numbers are assigned to the letters A-L in the Master menu. Next, the letters A-L are connected to synthesizer control parameters in the PatchCord section of the Edit menu. The PatchCord Amount scales the amount of each controller by a positive or negative value.

The factory presets have the MIDI A-L controls connected to standard synthesizer functions (marked on the front panel). By choosing any four of the 12 standard functions, the four sliders on your keyboard will work the same on every preset. The chart below shows how this might work if your keyboard transmitted the slider settings on MIDI controllers 21-24.

Control	MIDI Controller #	Routing	Standard Function
Slider 1	21	A	Controls Filter Frequency
Slider 2	22	B	Controls Filter Resonance
Slider 3	23	C	Controls Envelope Attack
Slider 4	24	D	Controls Envelope Release

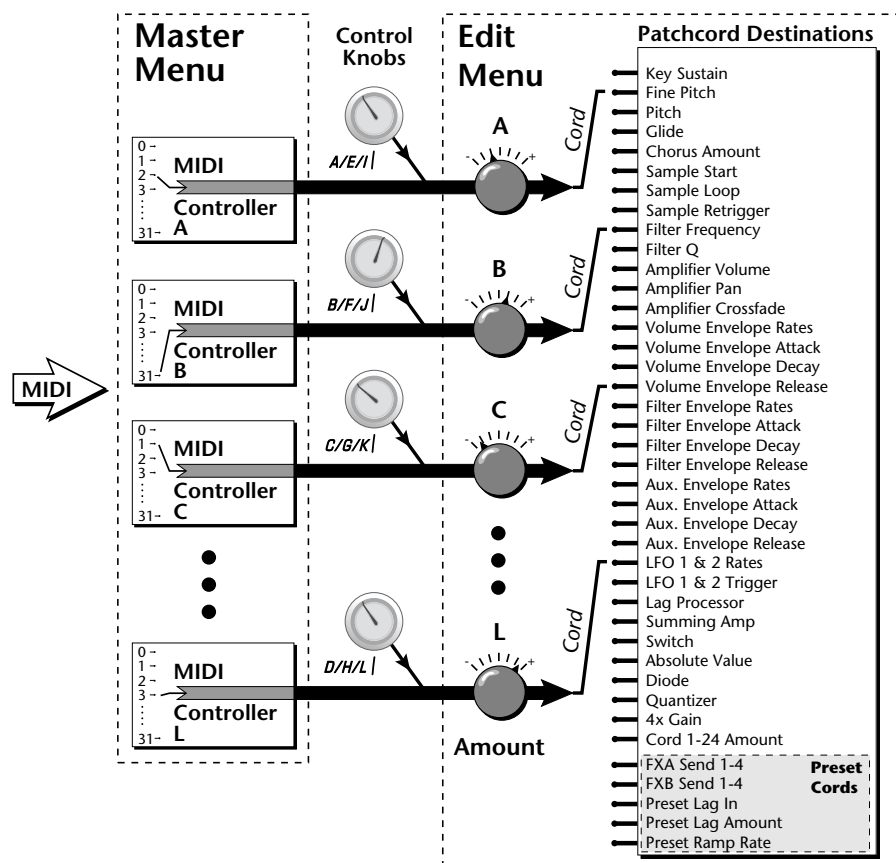

MIDI A-L are internal connections which simultaneously carry front panel controller knob data and MIDI continuous controller data.

The four controller knobs on the Xtreme Lead front panel work just like MIDI real-time controllers. The four controller knobs are permanently assigned to controllers A-L. Pressing the control button adjacent to the row of knobs selects A-D, E-H or I-L functions for the knobs. The front panel knob (A-L) and incoming MIDI controller messages assigned to that letter, both control the same parameter that you select in the PatchCord screen.

## Bank Select Commands

When the original MIDI specification was developed, synthesizers had only 8 to 40 preset locations. At that time being able to select up to 128 presets didn't seem like much of a limitation. So it was that the original MIDI specification provided for the selection of up to 128 presets.

Musicians screamed for *MORE* and so the MIDI specification was later amended to include **Bank Select Commands**. It was decided that Bank Select Commands would use Continuous Controllers 0 and 32 to allow the selection of up to 16,384 banks of 128 presets (over two million presets).

Because Bank Selects are implemented using Continuous Controllers, the Bank Selections can be made *per channel*. (This is getting better and better.) For each MIDI channel, you can select any of 16,384 banks and then one of the 128 presets in the bank. Of course no synthesizer has 16,384 banks (yet), but hey, it's nice to know it's possible (for that really BIG project).

Continuous Controller (CC) 0 is the MSB (most significant byte) and CC 32 is the LSB (least significant byte). Normally you send both the MSB and LSB controllers to implement a bank change.

Xtreme Lead remembers the MSB and the LSB that were last sent (or last changed from the front panel). For example, if you have already set the Bank MSB to 04, you need only send the LSB to change banks within the Xtreme Lead sound set. See the MIDI Bank Select chart below.

The selected bank remains selected until you change it (either via MIDI or by changing the bank from the front panel). Standard MIDI Program Change commands select from 128 presets within the selected bank.

 When you press the Audition button, the Bank Select MSB and LSB are displayed on the top line of the display.

<b>MIDI BANK SELECT</b>			
	<b>MSB</b>	<b>LSB</b>	
	<b>cc00</b>	<b>cc32</b>	
<b>USER</b>	00	00	Bank 0
<b>USER</b>	00	01	Bank 1
<b>USER</b>	00	02	Bank 2
<b>USER</b>	00	03	Bank 3
<b>XTREME</b>	07	00	Bank 0
<b>XTREME</b>	07	01	Bank 1
<b>XTREME</b>	07	02	Bank 2
<b>XTREME</b>	07	03	Bank 3

## Stereo Mix Outputs

This feature is useful for adding signal processing (EQ, reverb, etc.) of individual sounds prior to final mixdown.

The routing can be performed according to MIDI channel from the Mix Output screen in the Master menu. Simply assign each channel to the desired output.

**Master  
Menu**

MIX OUTPUT  
channel 01: Send 2

To route a particular preset to a Send, first go to the Mix Output screen in the Master menu and set the MIDI channel to "Preset".

**Master  
Menu**

MIX OUTPUT  
channel 01: Preset

Next set the Mix Output routing in the preset to the desired output (for each layer). Yes, you can send each layer to a different send if you want.

**Edit  
Menu**

L1 MIX OUTPUT  
Send 2

By sending different amounts of presets to the effects, subtle or striking effects can be achieved using the two effect processors. This feature allows you to get the most out of two effects since you can have eight different mixes.

For more information, refer to the diagram on the following page or, See "Mix Output" on page 75.

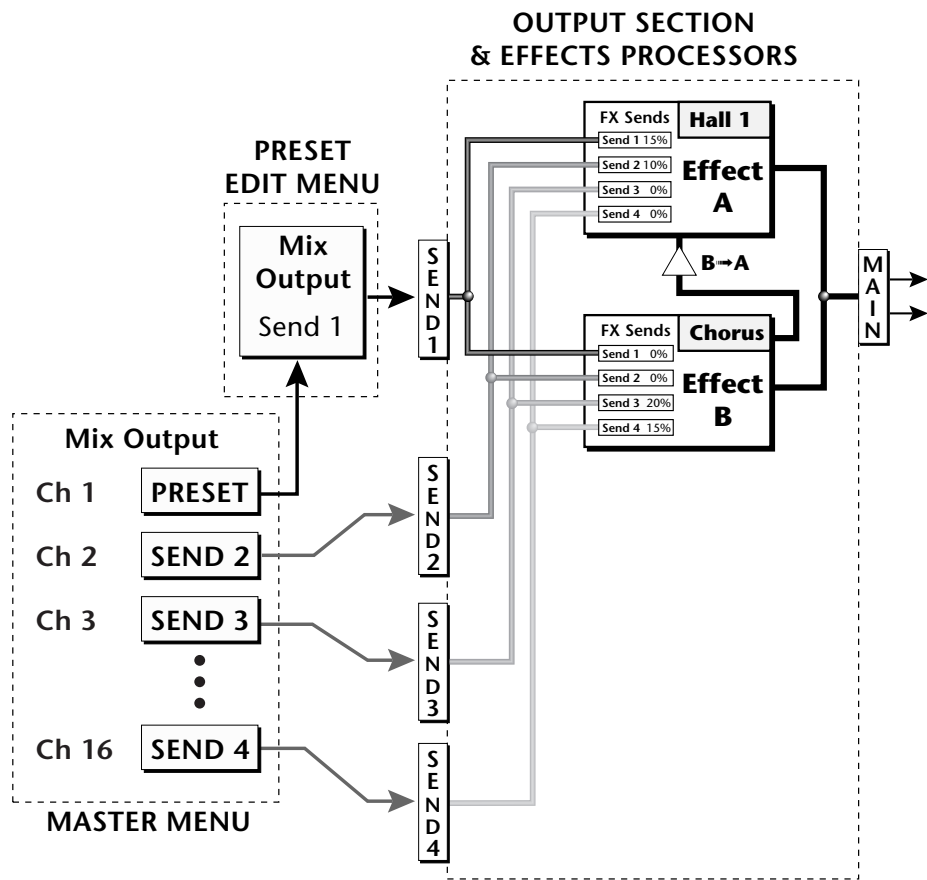

The Mix Output screen in the **Master** menu assigns each MIDI channel to a Send (1-4) or to "Preset".

The Mix Output screen in the **Edit** menu is ONLY used if the Master Mix Output is set to "Preset". Otherwise the Edit menu Mix Output settings are ignored.



# Edit Menu



*While the Edit menu is activated, all incoming MIDI preset changes on the selected channel are ignored.*



*If there is no "A" option in the Layer field, you must enable the "Edit All Layers" function in the Master Menu.*

The Edit Menu contains four layers of preset parameters that you can modify and then save as preset information in one of the user preset locations.

There are four instrument layers in the Edit menu. See the illustration on page 123 for a description of the Preset Layer model.

## ► To Access the Edit Menu

Press the Edit button, lighting the LED. The Edit Menu screen displays the menu page most recently selected since powering up Xtreme Lead. The cursor appears below the first character of the screen heading on line one.

## ► To Scroll through Layers

Place the cursor below the layer field. Rotate the Data Entry Control to select a layer (1-4).

You can also select **All Layers** by choosing "A" in the layer field. When All Layers is selected, the existing parameter value for any field will be displayed if the values of all four layers are equal. If the values of all four layers are NOT equal, the value of layer 1 will be displayed with flashing characters. If you change the parameter value, all layers will assume the new value and the display will stop flashing.

## ► To Scroll through Pages

Place the cursor below the page title field. This will automatically be done when you press the Home/Enter button. Rotate the Data Entry Control to scroll through the pages.

## ► To Change a Parameter

Place the cursor below the parameter field. Rotate the Data Entry Control to change the parameter value.

## Preset Name

The Preset names consists of two parts: a 3 letter preset category and a 12 letter preset name. Position the cursor under the character location and use the data entry control to change the character.

The preset category is used in conjunction with the Sound Navigator feature. Using the Sound Navigator, a category is selected and the presets in that category are listed in alphabetical order. Creating categories makes it easier to find specific sounds when you need them. For more information on Sound Navigator, see Sound Navigator in Chapter 2: Operations.



The keyboard can also be used to select character. The charts below show the keyboard character assignments.

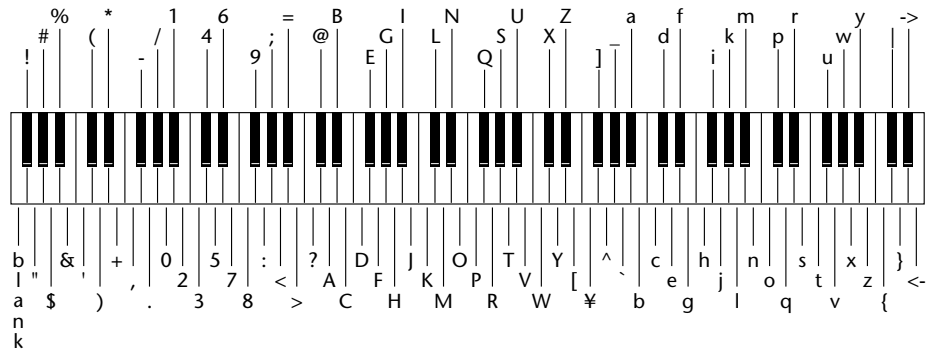

	C	C#	D	D#	E	F	F#	G	G#	A	A#	B	Pitch
-2						blank	!	"	#	\$	%	&	
-1	'	(	)	*	+	,	-	.	/	0	1	2	
0	3	4	5	6	7	8	9	:	;	<	=	>	
1	?	@	A	B	C	D	E	F	G	H	I	J	
2	K	L	M	N	O	P	Q	R	S	T	U	V	
3	W	X	Y	Z	[	¥	]	^	_	`	a	b	
4	c	d	e	f	g	h	i	j	k	l	m	n	
5	o	p	q	r	s	t	u	v	w	x	y	z	
6	{		}	→	←								

Octave

## Four Layer Architecture

Xtreme Lead provides a 4 layer instrument structure. Each layer is a complete synthesizer voice with 50 filter types, over 64 modulation sources, more than 64 modulation destinations and 24 patchcords to connect everything together. In addition, the four layers can be crossfaded or switched by key position, velocity or any real-time modulation source.

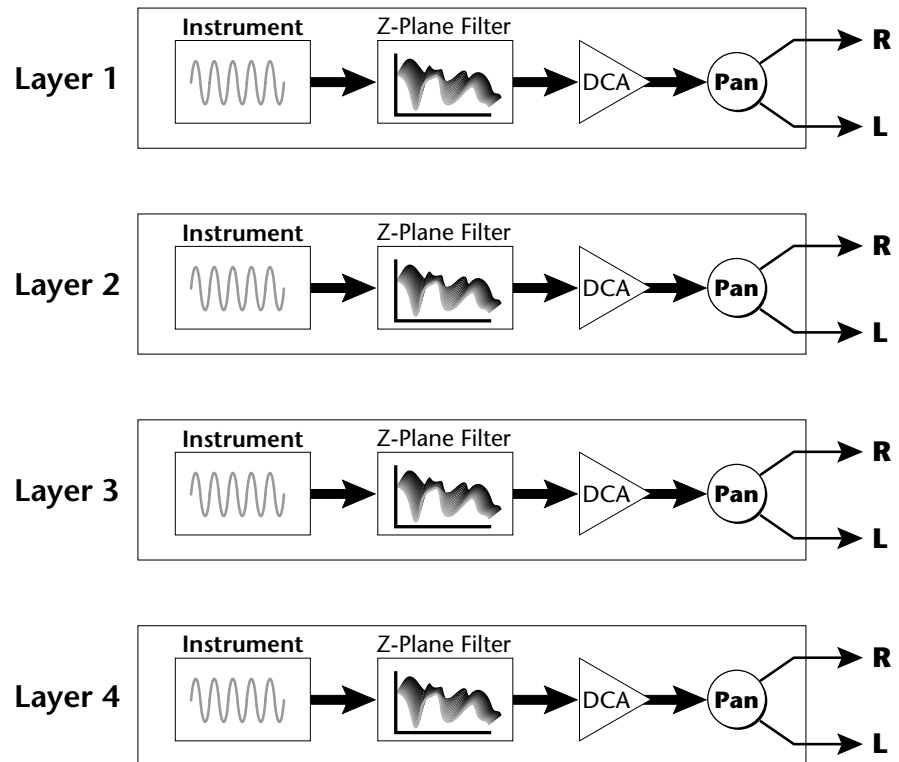

### Selecting Layers

In most of the Edit screens, the selected layer is shown in the upper left corner of the display. Layers 1-4 or All can be selected by positioning the cursor on this field and using the Data Entry Control to change the layer. In the screen shown below, Layer 1 is selected.

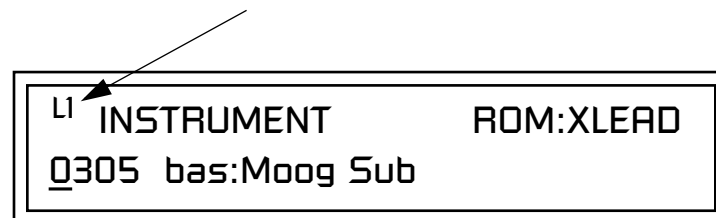

When "All Layers" (A) is selected, the existing parameter value for any field will be displayed if all layers are equal. If the layer parameter values are NOT equal, the value of Layer 1 will be displayed with flashing characters. If you move the Data Entry Control all values will be equal to this new value and the parameter value will no longer flash.

# Defining Layer Parameters

## Selecting an Instrument

The Edit menu parameters define the four layers and include the instrument assigned to the layer, the ranges of the layer, tuning, envelopes, filters, and patch cords. These parameters are defined for each layer on an individual basis (based on the currently selected layer). See “Common Preset Parameters” on page 154 for global preset settings.

The Instrument parameter defines which of the available instrument sounds is played by the current layer.

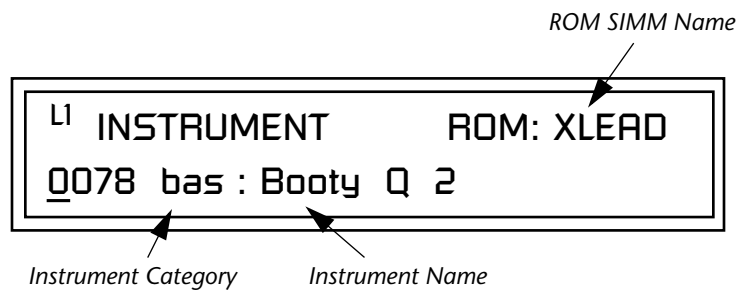

To select an instrument for the selected layer(s), move the cursor to the bottom line of the display and change the instrument using the Data Entry Control.

### Sound Navigator

Sound Navigator also works to help select Instruments although the category names are predefined. When the cursor is on the Instrument Category field, turning the Data Entry Control selects different instrument categories. The Name Field will change to show the first instrument in each category. Move the cursor to the instrument name to select instruments in the selected category.

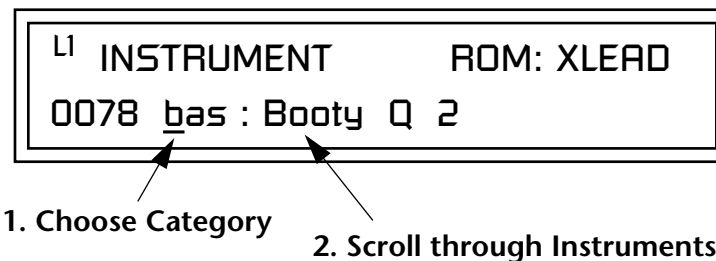

Selecting Categories of Instruments using Sound Navigator.

## Defining Key Range

The Key parameter defines the range on the keyboard used by the current layer. The Key range is from C-2 through G8.

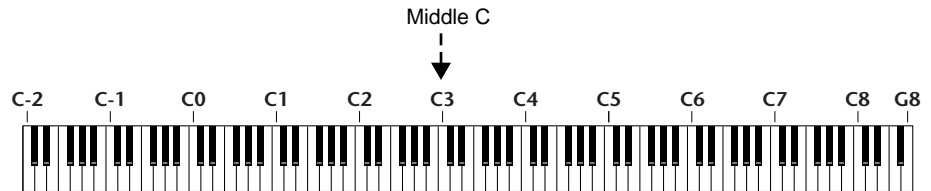

To define the range, set the low key value and the high key value.

You can select key numbers by simply pressing the desired keyboard key when the cursor is positioned on the low or high key field in the display.

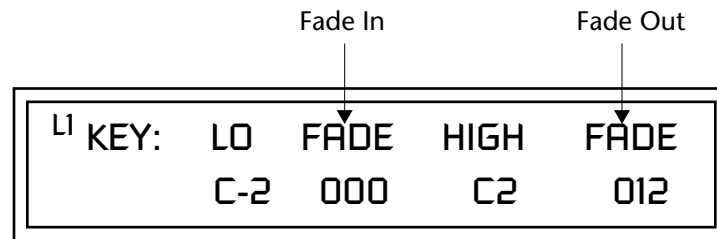

Layers can be crossfaded according to key position by adjusting the Low and High Fade parameters. The first Fade field determines how many semitones it takes the layer to Fade In from the low key. The second Fade field determines how many semitones it takes the layer to Fade Out to the high key. The screen shot above and the diagram below show Layer 1 being faded out over a one octave range.

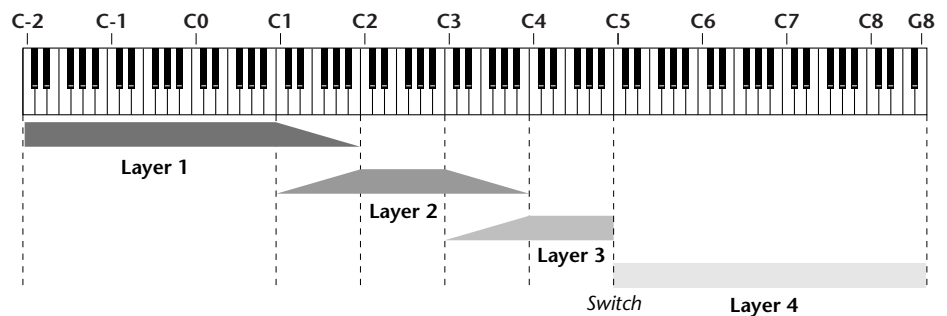

With a High Fade value of zero (as in layer 3 of the diagram), the layer simply switches off at the high key.

► To Switch Layers According to Key Position

The Key Range parameter allows you to create a “split” keyboard with up to four sounds adjacent to each other on the keyboard. This is shown in the diagram below.

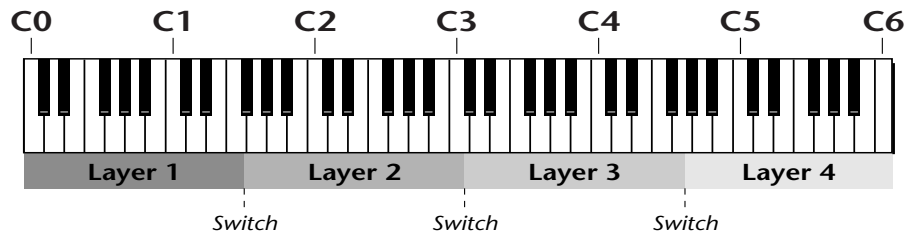

Just assign the low and high key range for each of the four layers with Fade set to zero. Set the Low and High Keys so they don't overlap other layers.

 You can select key numbers by simply pressing the desired keyboard key when the cursor is positioned on the low or high key field in the display.

L <sup>1</sup> KEY:	LO	FADE	HIGH	FADE
	<u>C</u> 0	000	F1	000

L <sup>2</sup> KEY:	LO	FADE	HIGH	FADE
	<u>F</u> #1	000	C3	000

L <sup>3</sup> KEY:	LO	FADE	HIGH	FADE
	<u>C</u> #3	000	F#4	000

L <sup>4</sup> KEY:	LO	FADE	HIGH	FADE
	<u>G</u> 4	000	C6	000

If two layers do overlap, both will play as shown in the next example.

► **To Stack Layers**

If the ranges of two or more Layers overlap it is called *stacking layers*. All Layers assigned to a key sound when the key is played. This is shown in the following diagram. It's very easy to stack layers. Simply duplicate the key ranges for any layers you want to stack.

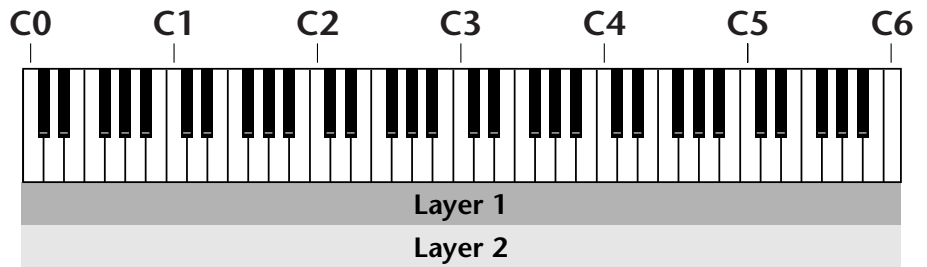

L <sup>1</sup> KEY:	LO	FADE	HIGH	FADE
	<u>C0</u>	000	C6	000

L <sup>2</sup> KEY:	LO	FADE	HIGH	FADE
	<u>C0</u>	000	C6	000

## Defining the Velocity Crossfade Range

Velocity is a measure of how hard the key is pressed. Velocity Range lets you control the volume of the layers using velocity. Using this function you can crossfade or cross-switch between layers according to how hard you play the keyboard.

Set the velocity range of the layer by defining the high and low velocity values. Values range from 0 (off) to 127 (hardest).

L2	VEL:	LO	FADE	HIGH	FADE
		<u>36</u>	012	96	012

The Fade fields define the velocity crossfade range for the currently selected layer. The first Fade field defines the Fade In range for the low velocity value. The second defines the Fade Out range for the high velocity value.

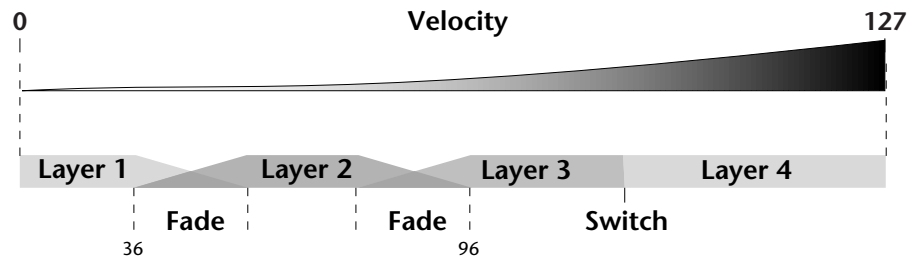

With soft playing, Layer 1 sounds. As you play harder, Layer 1 gradually fades out and Layer 2 fades in. When the keyboard is played hard, Layer 3 plays.



► To Set Up a Velocity Crossfade Between Layers

Set the velocity fades so that layer 1 fades out with higher key velocity, while layer 2 fades in. At a velocity of 64, the two sounds are equal volume. You may want to adjust the fade in and fade out points to achieve a natural sounding crossfade. These parameters vary depending on the sounds.

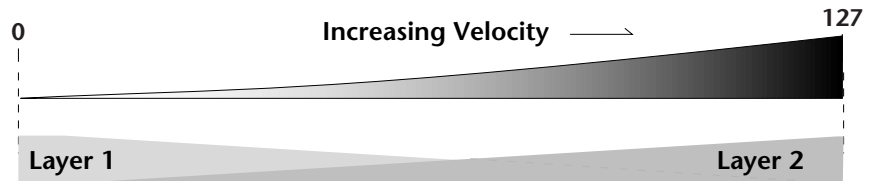

L <sup>1</sup>	VEL:	LO	FADE	HIGH	FADE
		<u>000</u>	000	127	127

L <sup>2</sup>	VEL:	LO	FADE	HIGH	FADE
		<u>000</u>	127	127	000

## Defining the Real-time Crossfade Range

The Real-time Crossfade window lets you control the volume of the four layers using a real-time controller such as a front panel knob, a pedal or an LFO or Envelope generator. The controller is defined by the PatchCord parameter (see “PatchCords” on page 150).

The Fade fields define the crossfade range in velocity for the currently selected layer. The first Fade field defines the Fade In amount for the low Real-time Control value. The second defines the Fade Out amount for the high Real-time Control value. The Fade value range is from 0 to 127.

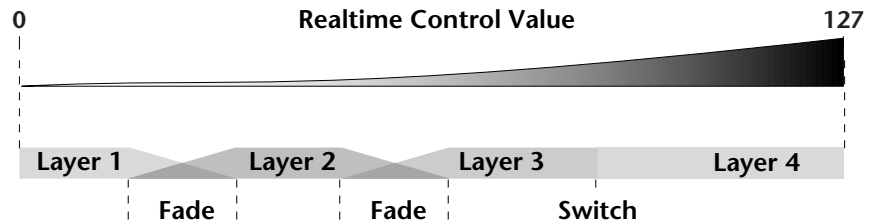

After the Ranges and Fades have been adjusted for each layer in the Real-time Crossfade screen, you must assign a real-time controller to RTXfade (Real-time Crossfade) on each Layer in the PatchCord screen. Set the PatchCord Amounts to +100.

### ► To Set Up a Real-time Crossfade Between Two Layers

As the real-time control (knob, pedal, LFO, etc.) is increased, Layer 1 fades out as Layer 2 fades in. This example only uses two of the possible four layers. Refer to the screen diagrams below.

L1	RT:	LO	FADE	HIGH	FADE
		000	000	127	127

L2	RT:	LO	FADE	HIGH	FADE
		000	127	127	000

1. Select a preset.
2. Press the Edit button to access the Edit menu.
3. Go to the Instrument page and select instruments for Layers 1 and 2.

4. Press Enter, then use the Data Entry Control to advance to the Real-time Crossfade page.
5. Define the High and Low range of each Layer. In this example the entire range of 0-127 is used.
6. Define the Fades for each Layer. This is just an initial setting. The Range and Fade parameters may have to be adjusted later to get a smooth crossfade.
7. Press Home/Enter and use the Data Entry Control to advance to the PatchCord page. Select Layer 1.
8. Select the modulation source for the crossfade (knob, pedal, LFO, Envelope) and set the destination to RTXfade. Set the Cord Amount to +100.
9. Select Layer 2. Select the same source and destination for the crossfade and set the Cord Amount to +127.

L1 PATCHCORD	#01
MidiA -> RTXfade	+100

10. Play the keyboard while adjusting the real-time controller. Go back to the Real-time Crossfade screens to fine tune the crossfade if necessary. Decreasing the fade size will narrow the region where both layers are sounding.

► **To Randomly Cross-Switch Between Four Layers**

In certain situations, you may want to switch between several layers randomly. **Crossfade Random** is a modulation source specifically designed to handle this situation. Unlike the other random sources, Crossfade Random generates one random number for all layers each time a key is pressed.

To set up a four layer Cross-Switch, simply assign each of the four layers to a different Real-time Crossfade range, then assign XfdRnd to RTXfade in the PatchCords for each layer.

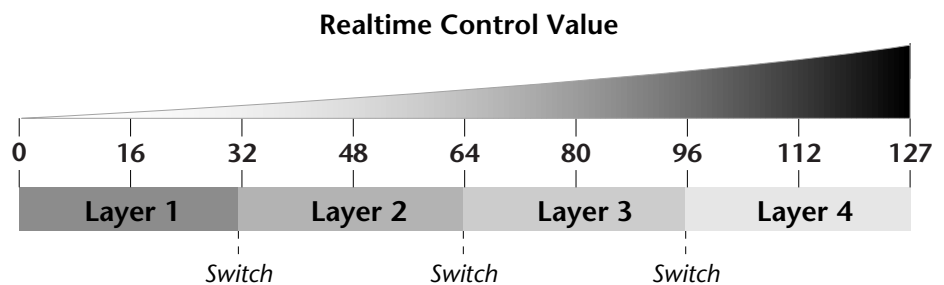

1. Press the Edit button to access the Edit menu.
2. Go to the Instrument screen and select Instruments for Layers 1 through 4.
3. Press Enter, then use the Data Entry Control to advance to the Real-time Crossfade page.

L1	RT:	LO	FADE	HIGH	FADE
		000	000	<u>031</u>	000

L2	RT:	LO	FADE	HIGH	FADE
		<u>032</u>	000	063	000

L3	RT:	LO	FADE	HIGH	FADE
		<u>064</u>	000	095	000

L4	RT:	LO	FADE	HIGH	FADE
		09 <u>6</u>	000	127	000

4. Define the High and Low range of each Layer as shown above.
5. Press Home/Enter and use the Data Entry Control to advance to the PatchCord page. Select Layer 1.
6. Select XfdRnd as the modulation source and RTXfade as the destination. Set the Cord Amount to +100.
7. Repeat step 6 for the remaining three layers.

*Transposing the  
Instrument*

```
L1 PATCHCORD #01  
XfdRand -> RTXfade +100
```

8. That's it! Now set each Layer up the way you want. Try radically different instruments, filter settings, or tunings. Or you can make each layer just slightly different for a more natural effect. Try adjusting the Fades or overlapping the ranges if you want more than one layer to play at once.

The Transpose parameter lets you transpose the key of the current layer's Instrument. Transpose works by shifting the keyboard position in semitone intervals relative to middle C. Use this parameter to transpose different layers apart by semitone intervals. For example, by transposing one layer by +7 semitones, it will track other layers at a perfect fifth interval.

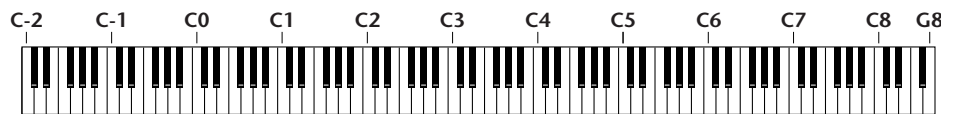

The range of transposition is -36 to +36 semitones.

```
L1 TRANSPOSE  
+36 semitones
```

## Tuning

The Tuning parameter changes the pitch of the key in semitone and 1/64 semitone intervals.

L1 <u>T</u> UNING			
Coarse:	+36	Fine:	+63

Use the Coarse field to shift the tuning by semitone intervals. Use the Fine field to shift tuning by 1/64 semitones (or 1.56 cents) intervals.

### Background: Transpose vs. Coarse Tuning

Transpose works by shifting the keyboard assignment of the Instrument (as if you were sliding the keyboard up and down with the Instrument remaining in the same position). Coarse Tuning keeps the instrument placement on the keyboard and actually tunes the samples up using a digital process called interpolation. Use Course Tuning on drum instruments to change the pitch while keeping sample placement constant. Coarse Tuning can also be useful to slightly change the timbre of the instrument.

## Amplifier

This parameter sets the initial volume and pan position of the current layer. These values can be changed using any Real-time Controller set up in the PatchCords. The value range for the volume is from -96 dB to +10 dB. 0 dB is the default setting. Routinely turning the volume up to +10 dB is not recommended because it doesn't allow other modulation sources to increase the volume further.

L1 <u>A</u> MPLIFIER			
Volume:	+10dB	Pan:	48L

This field determines the initial Pan value for the current layer. The value range for Pan is from 64L to 0 (left) and 0 to 63R (right). Pan adjusts the volume into the left and right output channels relative to the Pan setting in the main Preset Select screen (see "Channel Pan" on page 40). So, if you, for example, set the Pan value in the Preset Select screen to 64L and set this Pan value to 63R, the actual pan amount would be 0 as these two pan parameters are relative to each other.

## Volume Envelope

 *Factory Mode is useful for Instruments containing multiple drums, since each drum can have its own envelope settings.*

 *If two adjacent segments have the same level in a "time-based" envelope, the segment will be skipped. Adjacent segments must have different levels for the rate control to work.*

An envelope can be described as a "contour" which is used to shape the sound over time. The *Volume Envelope* controls the volume of the sound in the current layer over time. The way the volume of a sound evolves has a profound effect on how we perceive the sound.

Each instrument has its own Factory preset Volume Envelope setting. The Volume Envelope allows you to program your own envelope settings.

### Selecting the Mode

The Mode field determines whether the layer will use the instrument's default envelope (Factory) or use the user-programmed Volume Envelope. There are three mode options and repeat.

- **Factory:** Uses the factory preset envelope contained in each instrument. If you select the "Factory" mode, the Volume Envelope parameters are disabled and the factory defined settings are used instead.

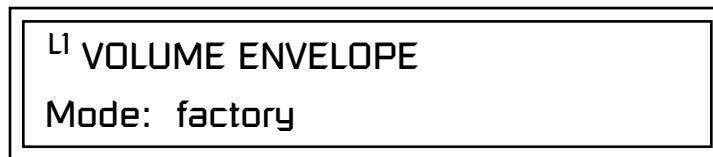

- **Time-based:** Defines the Volume Envelope rates from 0 to 127 (approximately 1 ms to 160 seconds). The Master clock has no affect on time-based rates.
- **Tempo-based:** The Volume Envelope times vary based on the master tempo setting. Note values are displayed instead of a number when the time corresponds to an exact note value. Tempo-based envelopes are useful when using external sequencers and arpeggiators because the envelope rates compress and expand according to the Master Tempo setting, keeping the envelopes in sync with the sequence or arpeggio.

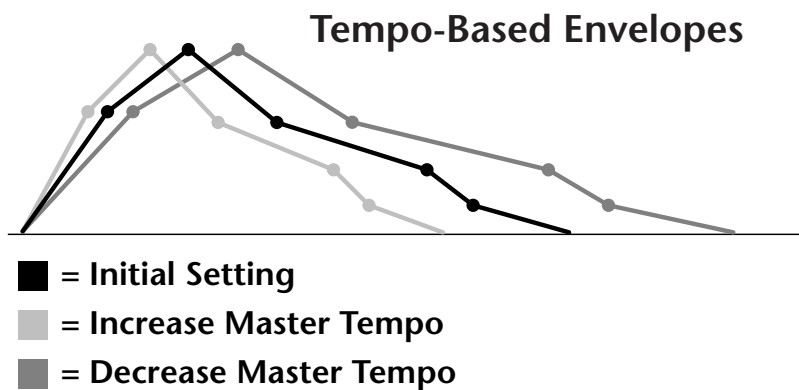

Tempo-based envelope rates change according to the Master Tempo rate.

 See the Programming Basics section of this manual for detailed information about how the Envelopes work.

### Defining the Volume Envelope

The Volume Envelope controls the volume of the layer over time. The Volume Envelope has six stages to the contour: Attack 1, Attack 2, Decay 1, Decay 2, Release 1 and Release 2. When a key is pressed, the Envelope goes through the first four stages. If you continue to hold down the key, the envelope holds at the Decay 2 level. When the key is released, the envelope continues through the Release stages ending at the Release 2 level.

L1	VOL ENV	RATE	LEVEL
	<u>A</u> ttack 1	84	100%

As soon as the Attack 1 level is reached, the Attack 2 phase begins. When the Attack 2 Level is reached, the Decay 1 phase begins. When the key is released, the envelope immediately jumps to the Release 1 stage, then the Release 2 stage finally ending at the Release 2 level.

If you have selected the factory mode, the Volume Envelope parameter screen looks like the following illustration.

L1	VOL ENV	RATE	LEVEL
	(using factory envelope)		

 If the Release 2 level is set at a value other than zero, the note will continue to sound after the key is released. This might be useful for drone effects, but the channel won't stop sounding until all channels are used up.

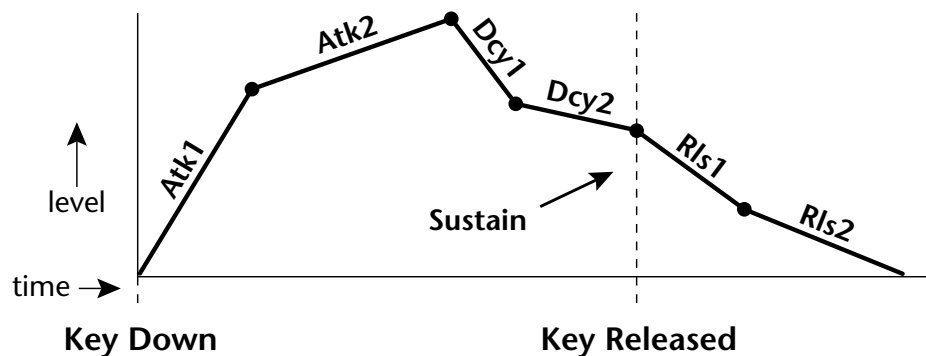

On the Volume Envelope, levels can only be set to positive values. The value range is from 0 to +100.



## Chorusing the Layer



**WARNING:** Because it works by doubling instruments, Chorusing halves the number of notes you can play.

Chorusing “thickens” the sound by doubling the sound in stereo and then detuning it. Every layer with chorus turned on uses twice the polyphony for that layer.

L1	CHORUS	WIDTH
	off	100%

The first field in this screen turns Chorus On or Off and allows you to adjust the amount of detuning (1 to 100%). The *Width* parameter controls the stereo spread. 0% reduces the chorus to mono and 100% provides the most stereo separation.

## Sound Start Offset and Delay

**Sound Start** sets where the instrument begins playing when you hit a key. Setting the Start Offset amount to “0” plays the sample from the beginning. Higher values move the Sample Start Point further into the sample toward the end. There is also a PatchCord source which can be used to change the Sound Start point at note-on time.

L1	SOUND	START	DELAY
		127	127

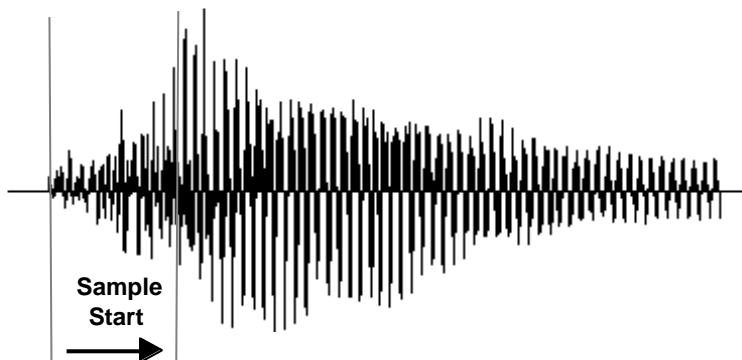

Controlling the Sound Start using Key Velocity (< Amt -) brings in the attack of the wave only when you play hard. This is especially effective with percussion instruments.

**Delay** defines the time between when you hit a key (note-on) and the onset of the current layer’s note and the start of the envelopes (if applicable). Delay values below zero are *Tempo-based* values, meaning the time is based on the Master Tempo setting. Note values are displayed by adjusting the Delay Time value below zero. The sound will be delayed by the selected note value based on the master clock.

## Non-Transpose Mode

This function turns keyboard transposition On or Off for the current layer. With Nontranspose “on,” the keyboard will not control the pitch of the instrument. This is a useful function for drones, attack “chiffs,” or other sound effects which you may not want to track the keyboard.



```
L1 NONTRANSPOSE
off
```

## Solo Mode

Provides the playing action of a monophonic instrument such as a lead synthesizer by preventing more than one note from sounding at once. There are eight different solo modes provided. Try setting up different layers with different solo mode and glide rates or combine solo mode with polyphonic playing modes.



```
L1 SOLO MODE
synth (low)
```



In order to define a monophonic glide (see the Portamento parameter), you must be in Solo mode.

The Solo modes are:

**Multiple Trigger:** Last note priority. No key-up action. Retrigger envelopes and samples when a key is pressed.

**Melody (last):** Last note priority. No key-up action.

*First solo note:* Envelopes start at Attack segment from zero. Samples start at the beginning.

*If previous note is releasing:* Envelopes start at Attack segment, but from current level. Samples start at the beginning.

*When playing “Legato”:* Envelopes continue from current segment and level. Samples start at the loop or the beginning if unlooped.

**Melody (low):** Same as Melody (last), but with low note priority. Newly played keys which are higher than the lowest solo key held do not sound.

**Melody (high):** Same as Melody (last), but with high note priority. Newly played keys which are lower than the highest solo key held do not sound.

**Synth (last):** Similar to Melody (last) but this mode has key-up action. When you release the currently sounding solo key while holding other keys down, the highest held solo key sounds in a Legato fashion.

## Assign Group

**Synth (low):** Same as Synth (last) but with low note priority. When you release the currently sounding solo key while holding other keys down, the lowest held solo key sounds in a Legato fashion (MiniMoog).

**Synth (high):** Same as Synth (last) but with high note priority. When you release the currently sounding solo key while holding other keys down, the highest held solo key sounds in a Legato fashion.

**Fingered Glide:** Same as Synth (last), except that Glide is disabled when playing Staccato, enabled when playing Legato.

Use the Assign Group parameter to assign a certain number of channels to each layer. By assigning all voices in the preset to assign groups, important parts are protected from being “stolen” by more recently played keys. Or you can assign a voice, such as an open high hat, to a mono channel so it is cancelled by a closed high hat on the same mono channel. Layers rotate within their assigned “bin” of channels, not interfering with other bins.

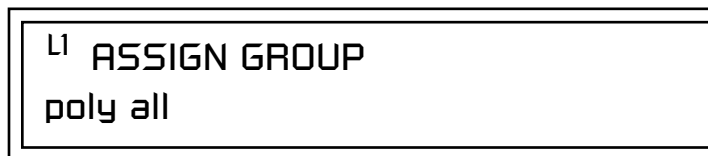

The modes are:

**Poly All:** Notes are played polyphonically with dynamic channel assignment using all 64 channels.

**Poly 16 A-B:** Two bins of 16 channels each. Notes are played polyphonically with dynamic channel assignment using no more than 16 channels.

**Poly 8 A-D:** Four bins of 8 channels each. Notes are played polyphonically with dynamic channel assignment using no more than 8 channels each.

**Poly 4 A-D:** Four bins of 4 channels each. Notes are played polyphonically with dynamic channel assignment using no more than 4 channels each.

**Poly 2 A-D:** Four bins of 2 channels each. Notes are played polyphonically with dynamic channel assignment using no more than 2 channels each.

**Mono A-I:** Nine monophonic channels, Any layers assigned to the same letter interrupt each other without affecting other layers.

## Glide

Glide creates a smooth transition from one note to the next instead of the normal instantaneous change in pitch when a new key is pressed. This effect is commonly heard on slide guitars, synthesizers and violins.

<b>L1</b>	<b>GLIDE RATE</b>	<b>CURVE</b>
	<b>0.000 sec/oct</b>	<b>linear</b>

The **Glide Rate** parameter defines the time it takes to glide to the new pitch (the larger the value, the slower the glide rate) The glide rate value range is from 0 through 32.738 seconds (zero means off).

The **Glide Curve** describes how the glide accelerates as it slides between notes. Because of the ear's non-linear response to pitch, a linear glide sounds slow at the beginning and speeds up toward the end. Exponential curves actually sound smoother and more linear. Eight exponential curves are provided. Choose one that suits your style.

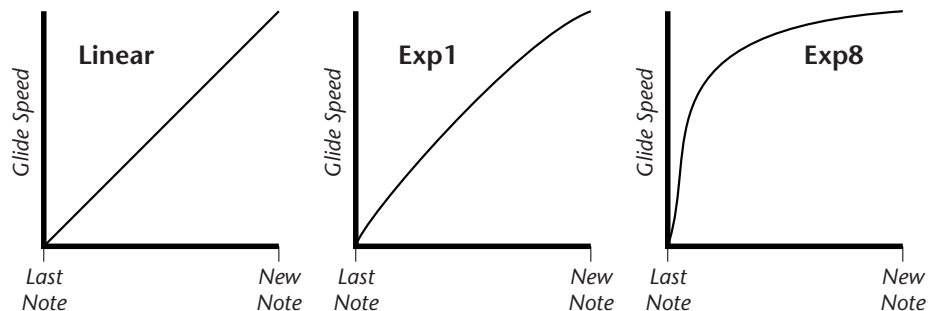

Glide can be either polyphonic or monophonic depending on the state of *Solo Mode*.

## Z-Plane Filters

A filter is a device which changes the output of a signal (sound) by removing certain elements of the signal based on the frequency and amplitude. The "Order" of a filter defines the number of filter elements it contains. The more elements, the more complex the filter.

Xtreme Lead contains 50 different types of E-mu's celebrated Z-plane filters. In addition to the standard Low pass, High pass and Band pass filters, Xtreme Lead contains Swept Octave Equalizers, Phasers, Flangers, Vocal Formant Filters, and digital models of classic synthesizer filters.

In the filter chart below you will notice that the "Order" of the filters varies from 2 to 12 order. Higher order filters have more sections and can produce more complex formants. XL-1 can produce 64 filters of up to 6th order or 32 filters of 12th order complexity. Therefore, if you decided to use all 12th

## Xtreme Lead Filter Types

order filters, XL-1 would be limited to 32 voices. See page 72 for more information about filters.

This screen allows you to choose the type of filter for the current layer.

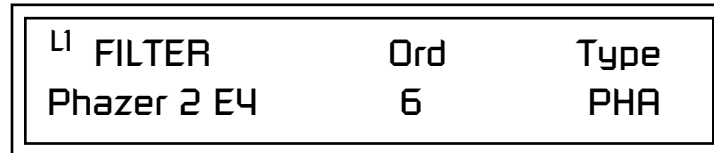

Filter Types	
LPF	Low-pass filter
PHA	Phaser
HPF	High-pass filter
FLG	Flanger
BPF	Band-pass filter
VOW	Vowel/ formant
EQ+	EQ boost
EQ-	EQ cut
SFX	Special Effect

Filter Name	Order	Type	Description
Smooth	02	LPF	Typical OB type low-pass filter with a shallow 12 dB/octave slope.
Classic	04	LPF	4-pole low-pass filter, the standard filter on classic analog synths. 24 dB/octave rolloff.
Steeper	06	LPF	6-pole low-pass filter which has a steeper slope than a 4-pole low-pass filter. 36 dB/octave rolloff!
MegaSweepz	12	LPF	“Loud” LPF with a hard Q. Tweeters beware!
EarlyRizer	12	LPF	Classic analog sweeping with hot Q and Lo-end.
Millennium	12	LPF	Aggressive low-pass filter. Q gives you a variety of spiky tonal peaks.
KlubKlassik	12	LPF	Responsive low-pass filter sweep with a wide spectrum of Q sounds
BassBox-303	12	LPF	Pumped up lows with TB-like squelchy Q factor.
Shallow	02	HPF	2-pole high-pass filter. 12 dB/octave slope.
Deeper	04	HPF	Classic 4-pole high-pass filter. Cutoff sweep progressively cuts 4th Order High-pass.
Band-pass1	02	BPF	Band-pass filter with 6 dB/octave rolloff on either side of the passband and Q control.
Band-pass2	04	BPF	Band-pass filter with 12 dB/octave rolloff on either side of the passband and Q control.
ContraBand	06	BPF	A novel band-pass filter where the frequency peaks and dips midway in the frequency range.
Swept1>1oct	06	EQ+	Parametric filter with 24 dB of boost or cut and a one octave bandwidth.
Swept2>1oct	06	EQ+	Parametric filter with 24 dB of boost or cut. The bandwidth of the filter is two octaves wide at the low end of the audio spectrum, gradually changing to one octave wide at the upper end of the spectrum.

Filter Name	Order	Type	Description
Swept3>1oct	06	EQ+	Parametric filter with 24 dB of boost or cut. The bandwidth of the filter is three octaves wide at the low end of the audio spectrum, gradually changing to one octave wide at the upper end of the spectrum.
DJAlkaline	12	EQ+	Band accentuating filter, Q shifts "ring" frequency.
AceOfBass	12	EQ+	Bass-boost to bass-cut morph
TB-OrNot-TB	12	EQ+	Great Bassline "Processor."
BolandBass	12	EQ+	Constant bass boost with mid-tone Q control.
BassTracer	12	EQ+	Low Q boosts bass. Try sawtooth or square waveform with Q set to 115.
RogueHertz	12	EQ+	Bass with mid-range boost and smooth Q. Sweep cutoff with Q at 127.
RazorBlades	12	EQ-	Cuts a series of frequency bands. Q selects different bands.
RadioCraze	12	EQ-	Band limited for a cheap radio-like EQ
AahAyEeh	06	VOW	Vowel formant filter which sweeps from "Ah" sound, through "Ay" sound to "Ee" sound at maximum frequency setting. Q varies the apparent size of the mouth cavity.
Ooh-To-Aah	06	VOW	Vowel formant filter which sweeps from "Oo" sound, through "Oh" sound to "Ah" sound at maximum frequency setting. Q varies the apparent size of mouth cavity.
MultiQVox	12	VOW	Multi-Formant, Map Q To velocity.
Ooh-To-Eee	12	VOW	Oooh to Eeee formant morph.
TalkingHedz	12	VOW	"Oui" morphing filter. Q adds peaks.
Eeh-To-Aah	12	VOW	"E" to "Ah" formant movement. Q accentuates "peakiness."
UbuOrator	12	VOW	Aah-Uuh vowel with no Q. Raise Q for throaty vocals.
DeepBouche	12	VOW	French vowels! "Ou-Est" vowel at low Q.
PhazeShift1	06	PHA	Recreates a comb filter effect typical of phase shifters. Frequency moves position of notches. Q varies the depth of the notches.
PhazeShift2	06	PHA	Comb filter with slightly different notch frequency moving the frequency of notches. Q varies the depth of the notches.
FreakShifta	12	PHA	Phasey movement. Try major 6 interval and maximum Q.
CruzPusher	12	PHA	Accentuates harmonics at high Q. Try with a sawtooth LFO.

Filter Name	Order	Type	Description
FlangerLite	06	FLG	Contains three notches. Frequency moves frequency and spacing of notches. Q increases flanging depth.
AngelzHairz	12	FLG	Smooth sweep flanger. Good with vox waves. eg. I094, Q =60
DreamWeava	12	FLG	Directional Flanger. Poles shift down at low Q and up at high Q.
MeatyGizmo	12	REZ	Filter inverts at mid-Q.
DeadRinger	12	REZ	Permanent "Ringy" Q response. Many Q variations.
ZoomPeaks	12	REZ	High resonance nasal filter.
AcidRavage	12	REZ	Great analog Q response. Wide tonal range. Try with a sawtooth LFO.
BassOMatic	12	REZ	Low boost for basslines. Q goes to distortion at the maximum level.
LucifersQ	12	REZ	Violent mid Q filter! Take care with Q values 40-90.
ToothComb	12	REZ	Highly resonant harmonic peaks shift in unison. Try mid Q.
EarBender	12	WAH	Midway between wah & vowel. Strong mid-boost. Nasty at high Q settings.
FuzziFace	12	DST	Nasty clipped distortion. Q functions as mid-frequency tone control.
BlissBatz	06	SFX	Bat phaser from the Emulator 4.
KlangKling	12	SFX	Ringing Flange filter. Q "tunes" the ring frequency.

### Filter Parameters

The Freq and Q parameters control various elements of the filter depending on the type of filter used. See the table in the *Filter Types* section for details about what the Freq and Q fields control in each filter.

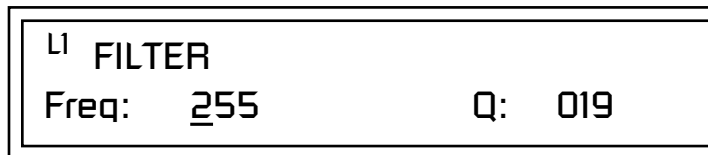

### Filter Envelope

The Filter Envelope is normally used to control the filter frequency and has six stages. Unlike the Volume Envelope, the Filter Envelope must be patched to the Filter Frequency using a PatchCord. In this respect, it can be thought of as a general purpose envelope generator which is normally patched to control the filter. The Filter Envelope Levels can be negative as well as positive.

There are three mode options:

- **Time-based:** Defines the Filter Envelope rates from 0 to 127 (approximately 1 ms to 160 seconds). The Master clock has no affect on time-based rates.

L1	FILT ENV	RATE	LEVEL
	Attack 1	<u>8</u> 4	100%

- **Tempo-based:** The Filter Envelope times vary based on the master tempo setting and are displayed in values such as 1, 2, 3, etc. Note values are displayed instead of a number when the time corresponds to an exact note value. Tempo-based envelopes are useful when using arpeggiators and sequencers because the envelope rates compress and expand according to the Master Tempo setting, keeping the envelopes in sync with the music. See the illustration on page 96.

L1	FILT ENV	RATE	LEVEL
	Attack 1	<u>1</u> /4	100%

- **Envelope Repeat:** The Envelope Generators can also be made to repeat. When the envelope repeat function is On, the Attack (1&2) and Decay (1&2) stages will continue to repeat as long as the key is held. As soon as the key is released, the envelope continues through its normal Release stages (1 & 2). For more information, see “Envelope Repeat” on page 96.

► **To Turn on Envelope Repeat:**

1. Move the cursor until it is underneath the Mode field as shown below.

L1	FILTER ENVELOPE
	<u>M</u> ode: time-based

2. Turn the data entry control clockwise. The lower line changes to:

L1	FILTER ENVELOPE
	Repeat: <u>o</u> ff

3. Move the cursor underneath the on/off field, then turn the data entry control clockwise so that Repeat is On.



 See the Programming Basics section of this manual for detailed information about how the Envelopes work.

 The default PatchCord settings connect the Filter Envelope to Filter Frequency but the envelope can be routed to any real-time control destination using a PatchCord.

### Defining the Filter Envelope

The Filter Envelope controls the filter frequency of the layer over time. The Envelope has six stages to the contour: Attack 1, Attack 2, Decay 1, Decay 2, Release 1 and Release 2. When a key is pressed, the Envelope goes through the first four stages. If the key continues to be held, the envelope holds at the Decay 2 level. When the key is released, the envelope immediately jumps to the Release 1 stage, then the Release 2 stage finally ending at the Release 2 level.

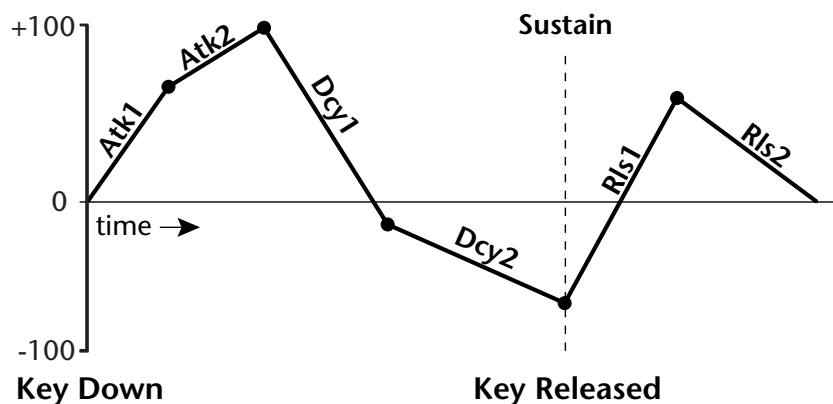

### Auxiliary Envelope

The Auxiliary Envelope is a supplementary general purpose envelope that can be routed to any real-time control destination in the PatchCords. It is identical to the filter envelope generator. See “Filter Envelope” on page 143 for full details.

### Low Frequency Oscillators (LFOs)

A Low Frequency Oscillator or LFO, is simply a wave that repeats at a slow speed. Xtreme Lead has two LFOs per layer identified on the display as LFO1 and LFO2.

An LFO can be routed to any real-time control destination using a PatchCord. LFOs have a myriad of uses, some of which probably haven’t been thought of yet. The following examples show a few common uses.

- Control the pitch of the sound (LFO -> Pitch). This effect is called “vibrato” and is an important performance tool. Many presets use this routing with the modulation wheel controlling “how much” modulation is applied.
- Create a “tremolo” effect by routing the LFO to control the volume (LFO -> AmpVolume).
- Add a bit of animation to the sound by routing the LFO to control the filter. Set the PatchCord amount low for a subtle effect.

The LFOs have five parameters: Shape, Sync, Rate, Delay and Variation.

### Shape

LFO waveforms have different shapes. The shape of the waveform determines the effect of the LFO. LFOs have traditionally been used to add vibrato or repeating movement to a sound. These new shapes offer a lot of new programming possibilities.

If you modulate the pitch of an instrument, it's easy to visualize the shape of the waveform. For example, the sine wave has a smooth, rolling shape that changes the pitch smoothly. The square wave changes between two pitches abruptly. A sawtooth waveform increases the pitch smoothly, then abruptly changes back down. The available waveforms are shown below.

#### LFO Tricks & Tips:

- The Random LFO wave is truly random and is different for each voice and layer.
- The Pattern (Pat) waveforms will sound the same on different layers and voices.
- Sine + Noise is very useful for simulating trumpet and flute vibrato.

#### ★ When routing Hemi-quaver to Pitch:

- +38 = major scale
- 38 = phrygian scale
- +76 = whole tone scale
- (+38) + (+76) = diminished (two cords)
- odd amount = S+H sound

**Note:** References to musical intervals in the pattern LFO shapes are with the LFO routed to pitch and a PatchCord amount of +38.

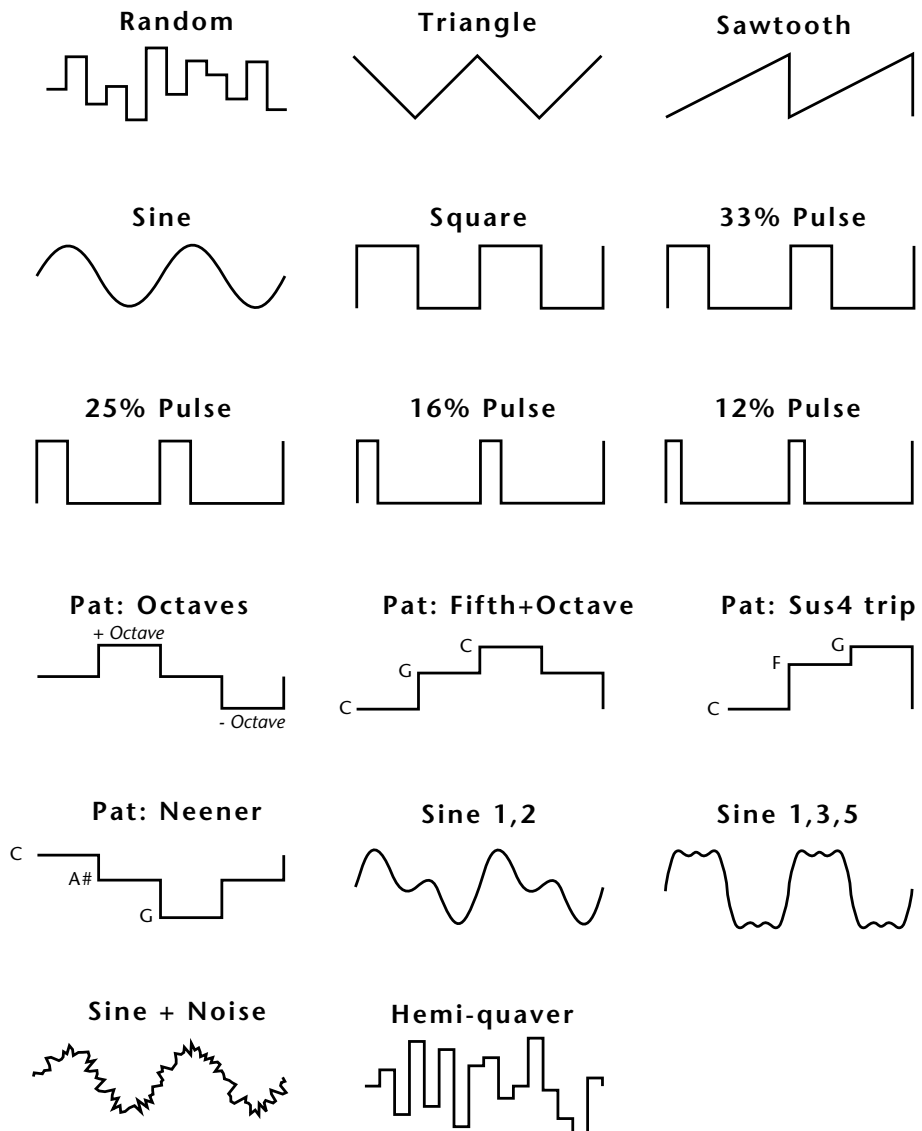

L1	LFO1	SHAPE	SYNC
		sawtooth	<u>key sync</u>

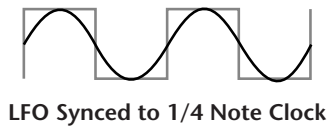

### Sync

The Sync field specifies whether the LFO is synchronized to a key stroke or is Free Running. Key Sync starts the LFO wave at the beginning of its cycle each time you press a key on the controller. In Free Run mode, the LFO wave begins at a random point in its cycle each time you press a key on the controller.

### Rate

The Rate field determines the LFO speed in absolute frequency rate values or tempo-based note values. All values equal to or greater than zero specify absolute frequency values from 0.08 Hz to 18.14 Hz.

Values less than zero specify tempo-based rates. If you modulate the rate of a tempo-based LFO, the rates will jump between the tempo-based note values with each PatchCord increment of "1". As an example: if the LFO rate was set to 8/1 and you patched the Mod Wheel to control rate with a PatchCord amount of +1, turning the Mod Wheel to maximum would change the LFO rate to 4/1d. Refer to the chart below.

L1	LFO1	RATE	DELAY	VAR
		<u>0.08Hz</u>	60	020

Tempo-based Rates (based on Master Tempo)	Display
octal whole note	8/1
dotted quad whole note	4/1d
octal whole note triplet	8/1t
quad whole note	4/1
dotted double whole note	2/1d
quad whole note triplet	4/1t
double whole note	2/1
dotted whole note	1/1d

<b>Tempo-based Rates (based on Master Tempo)</b>	<b>Display</b>
double note triplet	2/1t
whole note	1/1
dotted half note	1/2d
whole note triplet	1/1t
half note	1/2
dotted quarter note	1/4d
half note triplet	1/2t
quarter note	1/4
dotted 8th note	1/8d
quarter note triplet	1/4t
8th note	1/8
dotted 16th note	1/16d
8th note triplet	1/8t
16th note	1/16
dotted 32nd note	1/32d
16th note triplet	1/16t
32nd Note	1/32

### Delay

The Delay parameter defines the amount of time between hitting a key on the controller and the onset of the LFO modulation. Delay can be used to simulate an effect often used by acoustic instrument players where the vibrato is brought in only after the initial note pitch is established. The following illustration demonstrates how delay works.

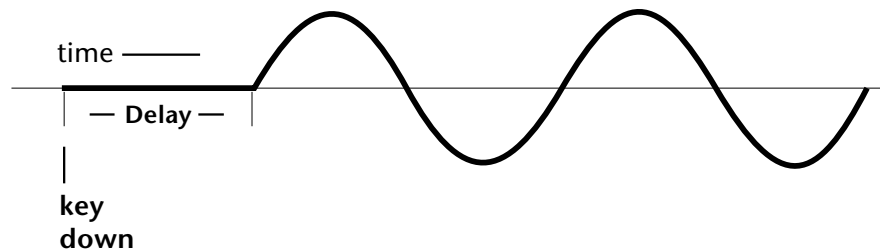

All Delay values equal to or greater than zero specify absolute time rates from 0 to 127. Values less than zero specify Tempo-based mode. Refer to the previous table for times and tempo-based rates.

 Variation is disabled when a Tempo-Based LFO is selected.

### Variation

LFO Variation sets the amount of random variation of the LFO each time you press a key on the controller. This creates a chorus or ensemble effect since each note played has a slightly different modulation rate. The higher the value entered, the greater the note to note variation in the LFO.

The Variation value range is from 0 through 100.

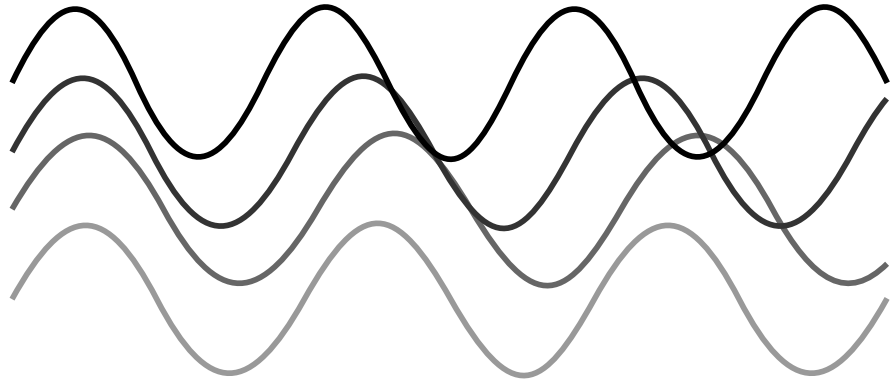

LFO variation changes the rate of each note to create an “ensemble” effect.

PatchCords

PatchCords tie everything together by connecting modulation sources to destinations. Each PatchCord has its own *Amount* control which can be positive or negative (negative amounts invert the signal). In addition, the PatchCord amounts themselves can be controlled by any modulation source. Xtreme Lead provides 24 patches for each layer.

There are three permanently connected control routings: volume envelope to amplifier, pitch wheel to pitch and key to pitch. All other connections must be made using the PatchCords.

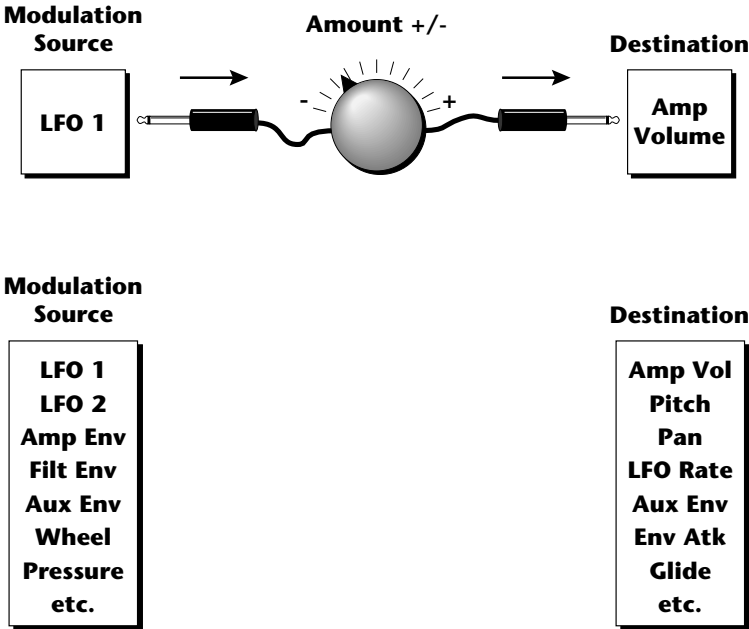

Each patch has an amount field which determines how much modulation is applied to the destination. The modulation amount can be positive or negative. Negative values invert the input. The amount value range is from -100 to +100.

```
L1 PATCHCORD #01
RlsVel -> AmpVol +100
```

```
L1 PATCHCORD #24
Key+ -> FiltRes -27
```

### Modulator Polarity

You will notice that some of the modulation sources have symbols following their names. For example, there are three Velocity modulation sources, Vel +, Vel ±, and Vel <.

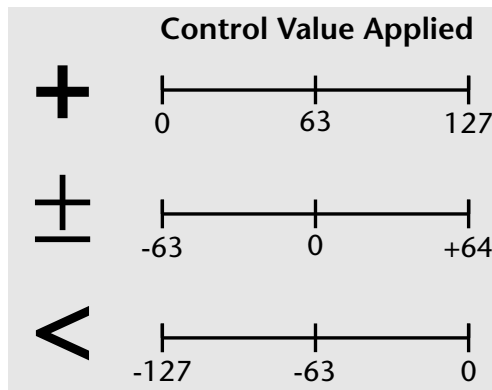
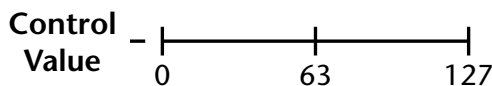

**Note:** Flip-Flop Footswitches 1 & 2 remain in their last condition when a new preset is selected. Flip-Flop Footswitch 3 resets to the Off condition whenever a new preset is selected.

**“+” Modulation:** Uses only the positive half of the range, adding to the current value. For example, if the filter frequency were set to 100 and you patched Vel+ to the filter, the filter frequency would increase from 100 as velocity was applied.

**“±” Modulation:** Uses both sides (full) range and both adding and subtracting from the current value. For example, if the filter frequency were set to 100 and you patched Vel ± to the filter, the filter frequency would decrease from 100 with key velocities of 63 or less and increase from 100 with key velocities of 64 and above. Therefore with medium velocity, the Filter frequency is approximately where you set it at 100.

An LFO ± works the same way; on the positive half of the cycle it increases the initial amount and on the negative half of the cycle it decreases the initial amount. With a ± modulation source, a value of 64 equals 0.

**“<” Modulation:** Uses only the negative half of the range, subtracting from the current value. For example, if the Amplifier Volume were set to +3 dB and you patched Vel < to AmpVol, the volume would be at +3 dB only when maximum key velocity were applied. Lower key velocities would scale back the volume. In general, < modulation is the proper choice when modulating Volume.

Refer to the following table for a list of modulation sources and destinations available in the Xtreme Lead.

<b>Modulation Sources:</b>	<b>Modulation Destinations</b>
Off	Off
Key (+, ±)	KeySust (Key Sustain)
Velocity (+, ±, <)	FinePtch (Fine Pitch)
RlsVel (Release Velocity)	Pitch
Gate	Glide
Pressure	ChrsAmt (Chorus Amount)
PitchWhl (Pitch Wheel)	'SStart (Sample Start) -note-on)
ModWhl (Modulation Wheel)	SLoop (Sample Loop)
Pedal	SRetrig (Sample Retrigger)
MIDI A-L	FiltFreq (Filter Frequency)
PLagOut (Preset Lag Out)	'FiltRes (Filter Resonance -note-on)
PRampOut (Preset Ramp Out)	AmpVol (Amplifier Volume)
FootSw1 - 3 (Foot Switch 1-3)	AmpPan (Amplifier Pan)
FootFF (Flip-Flop Foot Switch 1 -3)	RTXfade (Real-time Crossfade)
MIDI Volume (Controller 7)	VEnvRts (Volume Envelope Rates -all)
MIDI Pan (Controller 10)	VEnvAtk (Volume Envelope Attack)
KeyGlide	VEnvDcy (Volume Envelope Decay)
VolEnv +, ±, < (Volume Envelope)	VEnvRls (Volume Envelope Release)
FilEnv +, ±, < (Filter Envelope)	FEnvRts (Filter Envelope Rates -all)
AuxEnv +, ±, < (Auxiliary Envelope)	FEnvAtk (Filter Envelope Attack)
LFO 1 & 2 (+, ±)	FEnvDcy (Filter Envelope Decay)
White (White Noise)	FEnvRls (Filter Envelope Release)
Pink (Pink Noise)	FEnvTrig (Filter Envelope Trigger)
XfdRand (Crossfade Random)	AEnvRts (Auxiliary Envelope Rates -all)
KeyRand 1 & 2 (Key Random)	AEnvAtk (Auxiliary Envelope Attack)
Lag 0 sum (summing amp out)	AEnvDcy (Auxiliary Envelope Decay)
Lag 1 sum (summing amp out)	AEnvRls (Auxiliary Envelope Release)
Lag 0 & 1 (Lag Processor)	AEnvTrig (Auxiliary Envelope Trigger)
Clk Divisors (Octal, Quad, Double Whole, Whole, Half, Qtr, 8th,16th)	LFO 1 & 2 Rate
DC (DC Offset)	LFO 1 & 2 Trigger
Summing Amp	Lag Processor In 0 & 1
Sum	Sum (Summing Amp)
Switch	Switch
Absolute Value	Abs (Absolute Value)
Diode	Diode
Flip-Flop	Quantize
Quantizer	Flip-Flop
4x Gain	Gain 4x
	Cord 1-24 Amount



## Pitch Bend Range

Specifies the Pitch Wheel range in semitones for the current layer. Pitch Wheel is a standard synthesizer control which is transmitted as a MIDI continuous controller message used (normally) to bend the pitch up and down.

The PitchBend range is from 0 to  $\pm 12$  semitones or "Master." A setting of "0" turns the pitch wheel Off for the current layer. The Master setting uses the Pitch Bend range defined in the *Master menu*.



## Mix Output

This feature allows you to program the Effect Send as a part of the preset. Note that for this feature to work, the Mix Output setting in the Master menu MUST be set to "Preset" on the selected MIDI channel. If you want to define output routing by MIDI channel, set it up using the Mix Output page in the Master menu. See "Mix Output" on page 75 for more information.

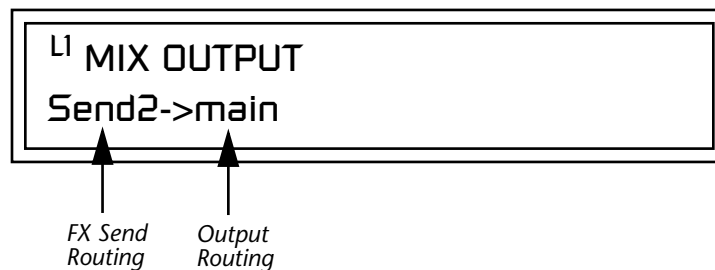

The Sends function as effect processor inputs (effect sends). The Output Routing field shows the true routing of the Sends to the Main output. The Output Routing never changes!

### ► To Control the Mix Output from the Preset:

1. Move the cursor until it is underneath the Layer field and change the Layer using the Data Entry Control.
2. Move the cursor until it is underneath the FX Send Routing field and change the Send (1-4) using the Data Entry Control.
3. Locate the MIX OUTPUT screen in the Master menu.
4. Set the MIDI channel you are using to "use preset".

# Common Preset Parameters

## Preset Effects

This section of the Edit menu chapter describes parameters that affect all layers in the preset.

Xtreme Lead has two stereo effects processors. When playing presets one at a time, the two processors can be programmed as part of the preset. The diagram below shows how the effects are integrated into the signal path using a parallel effects send/return model, similar to a mixing console.

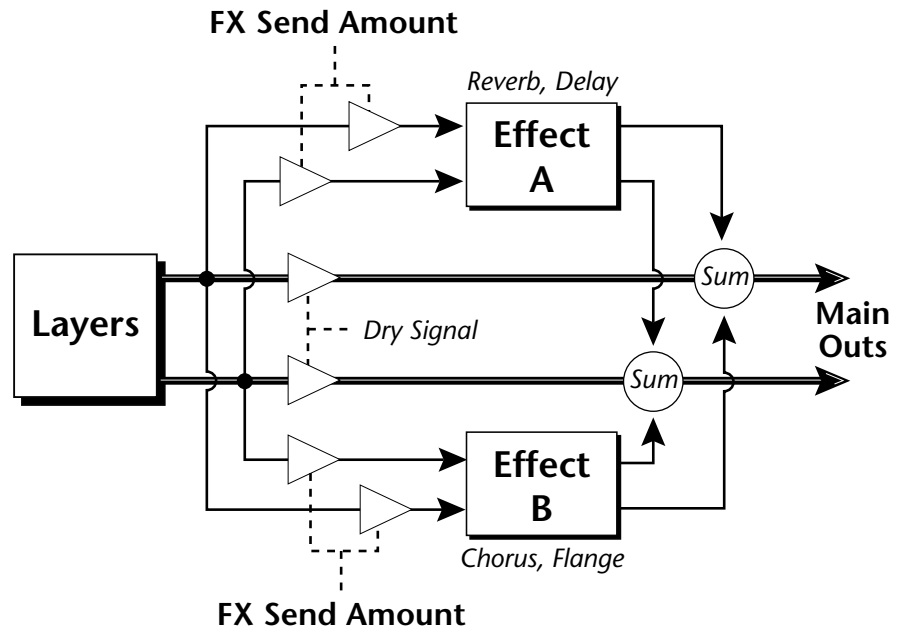

Refer to the Effects chapter for additional information and instructions for setting up both the Preset Effects and the Master Effects.

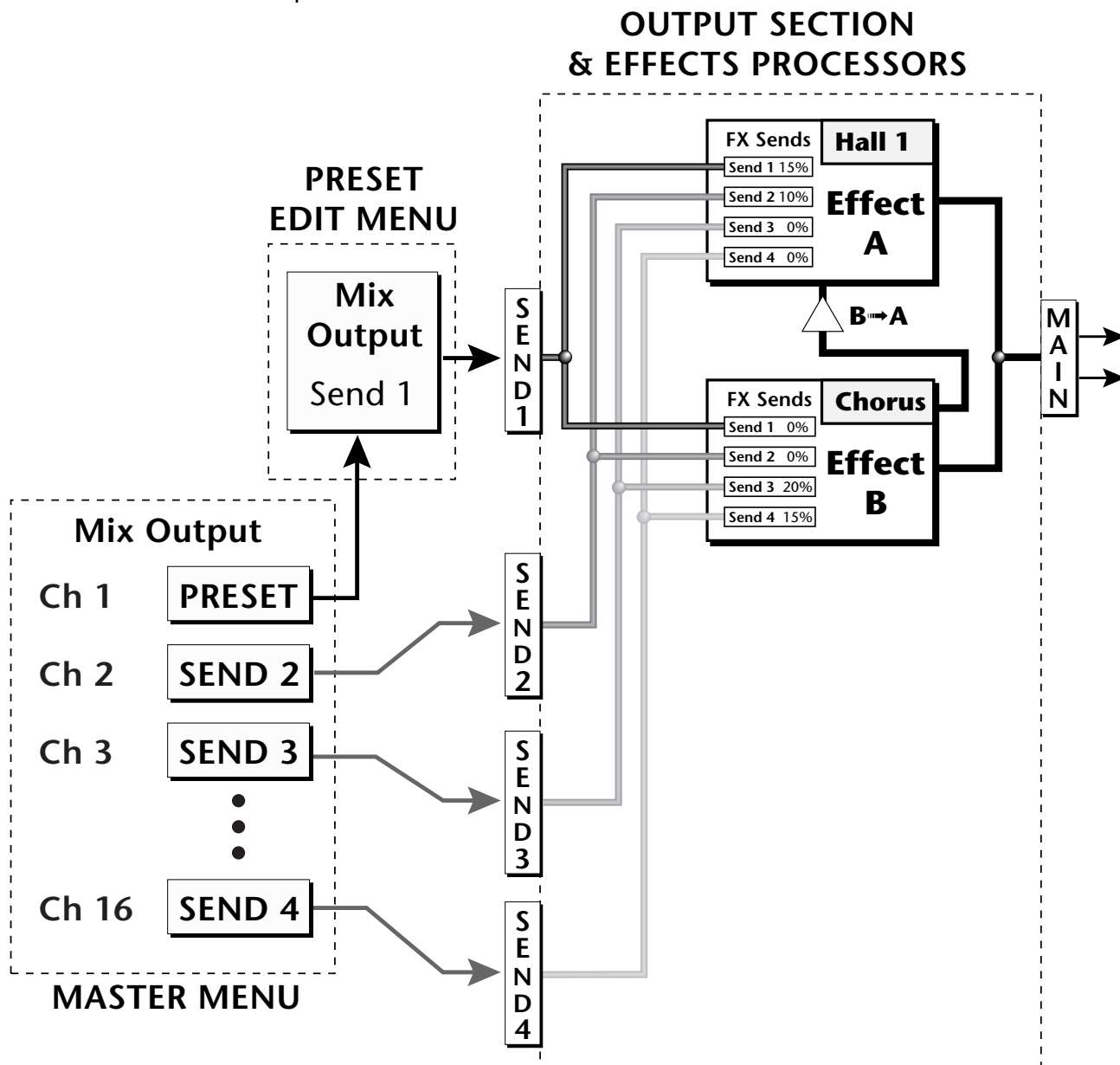

The Mix Output setting in the Master Menu determines if the Preset's Mix Output routing will be used. This allows the Sends to be programmed by either MIDI Channel or by Preset, whichever you prefer.

## FXA Algorithm

This screen selects the effect type for Effect Processor A. The “A” effects consist of different reverb types and digital delays. Move the cursor to the lower line of the display and select the effect you want.

**FXA ALGORITHM**  
**Lg Concert Pan**

### A Effect Types

- |                     |                       |
|---------------------|-----------------------|
| 1. Room 1           | 23. BBall Court       |
| 2. Room 2           | 24. Gymnasium         |
| 3. Room 3           | 25. Cavern            |
| 4. Hall 1           | 26. Concert 9         |
| 5. Hall 2           | 27. Concert 10 Pan    |
| 6. Plate            | 28. Reverse Gate      |
| 7. Delay            | 29. Gate 2            |
| 8. Panning Delay    | 30. Gate Pan          |
| 9. Multitap 1       | 31. Concert 11        |
| 10. Multitap Pan    | 32. Medium Concert    |
| 11. 3 Tap           | 33. Large Concert     |
| 12. 3 Tap Pan       | 34. Large Concert Pan |
| 13. Soft Room       | 35. Canyon            |
| 14. Warm Room       | 36. DelayVerb 1       |
| 15. Perfect Room    | 37. DelayVerb 2       |
| 16. Tiled Room      | 38. DelayVerb 3       |
| 17. Hard Plate      | 39. DelayVerb 4 Pan   |
| 18. Warm Hall       | 40. DelayVerb 5 Pan   |
| 19. Spacious Hall   | 41. DelayVerb 6       |
| 20. Bright Hall     | 42. DelayVerb 7       |
| 21. Bright Hall Pan | 43. DelayVerb 8       |
| 22. Bright Plate    | 44. DelayVerb 9       |

### FXA Parameters

The FXA parameters are Decay, High Frequency Damping, and the FxB to FxA send. **Decay** sets the length of time it takes an effect to fade out. **HF Damping** causes the high frequency energy to fade away more quickly during the reverb decay. **FxB to FxA** controls the amount of the “B” effect sent through effect “A”. This allows you to place the two effects in series and create setups such as “distortion through reverb” among others. Please refer to the Effects chapter for more information about the effects.

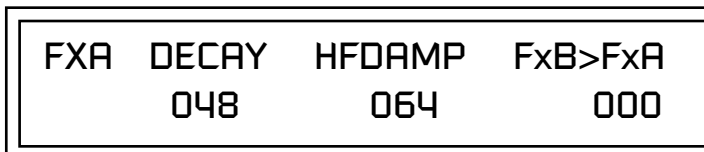

### FXA Send Amounts

These parameters set the effects amounts for each of the four stereo effects busses.

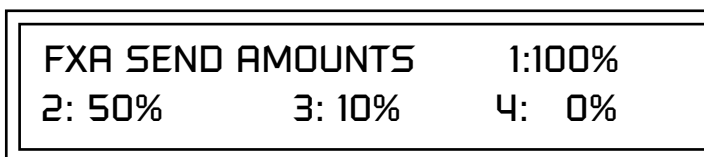

### FXB Algorithm

This screen selects the effect type for Effect Processor A. Move the cursor to the lower line of the display and select the effect you want.



#### B Effect Types

- |              |                    |                       |
|--------------|--------------------|-----------------------|
| 1. Chorus 1  | 12. Flange 5       | 23. PanDelay Chorus 1 |
| 2. Chorus 2  | 13. Flange 6       | 24. PanDelay Chorus 2 |
| 3. Chorus 3  | 14. Flange 7       | 25. Dual Tap 1/3      |
| 4. Chorus 4  | 15. Big Chorus     | 26. Dual Tap 1/4      |
| 5. Chorus 5  | 16. Symphonic      | 27. Vibrato           |
| 6. Doubling  | 17. Ensemble       | 28. Distortion 1      |
| 7. Slapback  | 18. Delay          | 29. Distortion 2      |
| 8. Flange 1  | 19. Delay Stereo   | 30. Distorted Flange  |
| 9. Flange 2  | 20. Delay Stereo 2 | 31. Distorted Chorus  |
| 10. Flange 3 | 21. Panning Delay  | 32. Distorted Double  |
| 11. Flange 4 | 22. Delay Chorus   |                       |

### *FXB Parameters*

The FXB parameters are Feedback, LFO Rate and Delay. **Feedback** sends the output of the effect back into the input. This creates multiple echoes on a delay effect and intensifies a chorus or flange effect. **LFO Rate** allows you to change the speed of the modulation oscillator for flange and chorus effects. **Delay** sets the length of the delay line. This affects the time between echoes, or the tone of flange effects.

FXB	FEEDBK	LFORATE	DELAY
	032	003	200ms

### *FXB Send Amounts*

These parameters set the effects amounts for the four stereo effects busses.

FXB SEND AMOUNTS	1:100%
2: 50%	3: 10%
	4: 0%

## Preset Patchcords

Preset PatchCords give you real-time control of global parameters. The effect processors are a powerful synthesis tool and this feature lets you control and use them in exciting new ways. For example, you can dynamically adjust the effects mix during a sequence or live performance.

There are many exciting performance possibilities using Preset PatchCords to control BEATs and Arpeggiator parameters. The front panel knobs “Wild 1-4” are usually connected to Arp and BEATs parameters in factory presets marked “arp:” or “bts:”. Likewise, Pitch and Mod wheels are often routed to “Beats Busy” and “Beats Variation” in factory presets marked “bts:”. Be sure to try out these controls

There are 12 Preset PatchCords per preset with a source, a destination and an amount control. The amount can be set from -100 to +100. The Preset PatchCord controls are *added* to the FX Send Amounts set in the Master or Edit menus. In other words, multiple sources connected to destinations are *summed*.



To crossfade between effects.

- 1) Set FXA Send 1 to 100%.
- 2) Set FXB Send 1 to 0%.
- 3) Set FX Cord #1 to FXA Send 1 at -100.
- 4) Set FX Cord #2 to FXB Send 1 at +100.

Increasing the controller amount will crossfade from FXA to FXB.

<b>PRESET CORDS</b>		<b>#01</b>
Pedal	-> FXBSend2	+100

### Modulation Sources:

Off  
PitchWhl (Pitch Wheel)  
ModWhl (Modulation Wheel)  
Pedal  
MIDI Volume (Controller 7)  
MIDI Pan (Controller 10)  
MIDI A-L  
Footswitch 1  
Flip-Flop Footswitch 1  
Footswitch 2  
Flip-Flop Footswitch 2  
Footswitch 3  
Flip-Flop Footswitch 3  
DC

### Modulation Destinations

Off  
Effect A Send 1  
Effect A Send 2  
Effect A Send 3  
Effect A Send 4  
Effect B Send 1  
Effect B Send 2  
Effect B Send 3  
Effect B Send 4  
Preset Lag In  
Preset Lag Amount  
Preset Lag Rate  
Preset Ramp Rate  
Arp Resolution  
Arp Extension  
Arp Velocity  
Arp Gate  
Arp Interval  
Beats Velocity Group 1-4  
Beats Transpose (Xpose) Group 1-4  
Beats Variation  
Beats Busy

## Initial Controller Amount

This parameter sets the initial value of MIDI controllers A-L when the preset is first selected. The front panel Control Knobs can be thought of as front panel MIDI controllers because in the Xtreme Lead, they are treated just as if they originated from an external MIDI device. Refer to the following diagram. There are three Initial Controller Amount screens (A-D, E-H, I-L).

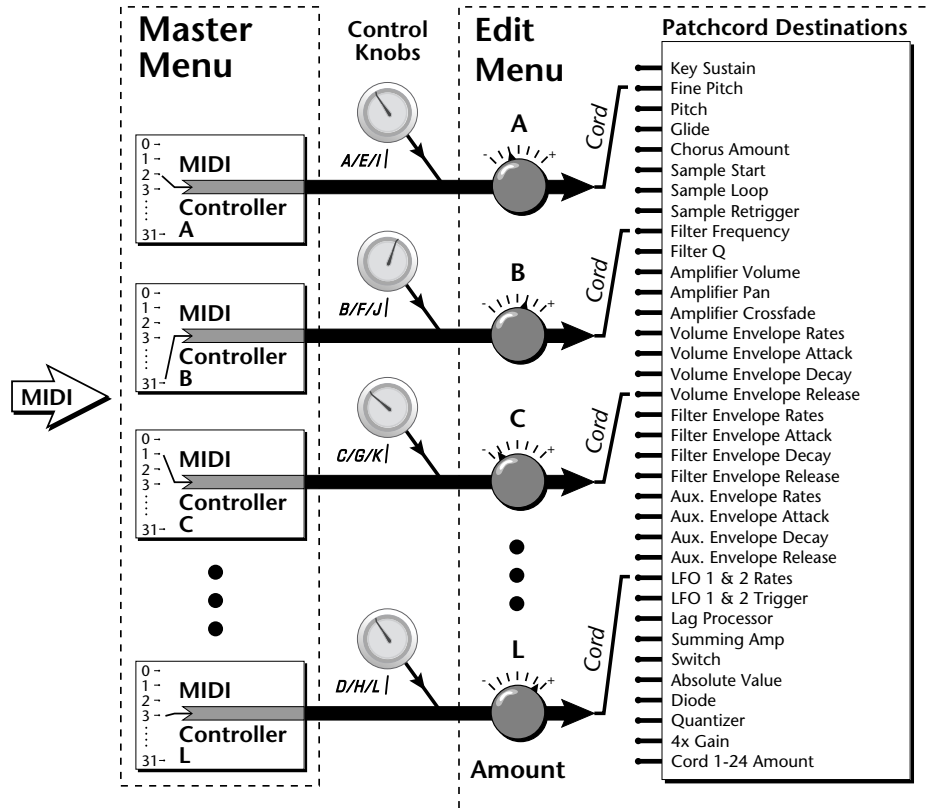

External MIDI controller numbers are assigned to the Letters A-L in the Master menu. The Initial Controller Amount value is sent to the PatchCord destination when the Preset is first selected. If you move the Control Knob, then that value replaces the initial value. If MIDI controller data is received it will similarly replace the knob or initial setting.



The Initial controller amounts can be set from 000-127 or they can be turned Off. If set to Off, the current controller value is used when the preset is first selected. Setting the Initial Amount to "off" uses the values from the previously selected preset.



## Keyboard Tuning

In addition to the standard equally divided octave tuning, Xtreme Lead contains twelve factory programmed tunings and 12 user-definable tunings. The Keyboard Tuning parameter selects which tuning is used by the current preset. The User Tuning tables are defined in the Master menu.

The factory Keyboard Tuning tables are described in the following table.

<b>Tuning Tables</b>	<b>Description</b>
<b>Equal Temperament</b>	Standard Western tuning (12 equally spaced notes per octave)
<b>Just C</b>	Just intonation. (Based on small interval ratios. Sweet and pure, non-beating intervals.)
<b>Vallotti</b>	Valotti & Young non-equal temperament. (Similar to 12 tone equal temperament. Each key has a different character for a given scale.)
<b>19-Tone</b>	19 tone equal temperament. (19 notes per octave. Difficult to play, but works well with a sequencer.)
<b>Gamelan</b>	5 tone Slendro and 7 tone Pelog. (Javanese. Pelog are white keys, Slendro are black keys. Exotic tunings of Gamelan flavor.
<b>Just C2</b>	Allows you to play the following chords in the key of C: C, E, F, G, A, B, C#m, D#m, Em, F#m, G#m, Am, Bm
<b>Just C-minor</b>	Allows you to play the following chords in the key of C: C, E, F, G, A, B, Em, Am, Bm, C#m, D#m, G#m
<b>Just C3</b>	Allows you to play the following chords in the key of C: C, D, F, Bb, C#m, Dm, Em, F#m, G#m, Am
<b>Werkmeister III</b>	A "well" temperament developed in the 17th century. Although you can play in all keys, each key sounds slightly different.
<b>Kirnberger</b>	Another well temperament developed by Johann Philipp Kirnberger where no pitch is more than 12 cents off from equal temperament.
<b>Scarlatti</b>	A variant of Meantone tuning which was used from the 15th to 18th centuries.
<b>Repeating Octave</b>	Middle C octave is repeated up and down the keyboard. Link with a preset in equal temperament to form unusual inversion up and down the keyboard.
<b>User 1-12</b>	Define your own tuning tables ( <i>Master menu</i> ).

Refer to "User Key Tuning" on page 90 in the Master Menu chapter for instructions on how to define your own Keyboard Tunings.



*Xtreme Lead implements the MIDI Tuning Dump protocol which allows you to create tuning tables on your personal computer and download them via MIDI. There are several computer applications available on the internet which let you create and download tuning tables via MIDI.*

## The Just C Tuning Tables

Well Tempered and Just were standard keyboard tunings up until the 20th-century when the current “equal tempered” scale became prevalent. In an equal tempered scale, the octave is equally divided into 12 parts. In Just or Well Tempered scales, the 12 notes are separately tuned to produce pure chords. However, in Just tunings you are limited to playing certain chords and if you play the wrong chord it may sound very BAD!

Xtreme Lead allows you to modulate between keys by providing you 12 user tuning tables. Tuning tables can be changed as you play using a program change (create several presets with the same sound and different tuning tables), by MIDI SysEx command (using a programmable MIDI footswitch or other device), or using a continuous controller (link 2 presets and crossfade between them using a controller). The Just C2, Just C min, Just C3 Tuning Tables

These new tuning tables take the concept of just intonation a step beyond previous E-mu products. Fully explaining the mysteries of just intonation is beyond the scope of this manual, but the subject is covered exhaustively in Hermann Helmholtz's On the Sensations of Tone, available at most libraries and bookstores.

The new tables are called Just C2, Just C3, and Just C Minor. Try playing in the key of C/Cm using each table. You'll quickly discover both the wonders and the frustrations of just intonation! In Just C, for example, you'll find that the chords C, Em, F, G, and Am sound beautiful. If you hold one of these chords, you'll hear no “beating”. After playing for a few minutes, switch back to Equal Temperament for a rude awakening!

At this point you might wonder why anyone would use Equal Temperament to begin with. For the answer to that question, play a D, Dmi, or Bb chord!.The intervallic ratios that make the C & G chords sound so pure make the D chord sound horribly out of tune. That's why we had to include Just C3. In this tuning, D, Dmi and Bb sound in tune, but the G chord will sound wrong.

Each of the 4 tables allows you to play a different group of common chords in just intonation. Sadly, there is no single 12 note tuning that will allow all of the common chords to be in tune, and of course that's why they invented the equal temperament tuning system that we use today.

### Just C

Play these chords: C, E, F, G, A, Cm, C#m, Em, F#m, Gm, Am

### Just C2

Play these chords: C, E, F, G, A, B, C#m, D#m, Em, G#m, Am, Bm

### Just C2 minor

Play these chords: C, D<sup>b</sup>, D, E<sup>b</sup>, G, A<sup>b</sup>, Cm, Em, Fm, Gm

### Just C3

Play these chords: C, D, F, B<sup>b</sup>, C#m, Dm, Em, F#m, G#m, Am

## Preset Links

You can link presets to other presets to create layering or keyboard splits. The current preset can be linked with up to two other presets (Links 1 & 2). Each linked preset can be assigned to a specific range in order to create keyboard splits or can be assigned a velocity range to switch links according to key velocity. In addition, you can specify Volume, Pan, Transpose and Delay settings for each Link. The modulation parameters specified in each preset remain in effect for each preset in the link.

LINK 1 Preset	XLEAD
000 <sup>2</sup> Preset Name	

LINK 1	KEY	VEL
RANGE	C-2	G8
		000-127

LINK 1	VOLUME	PAN
	+0dB	00

LINK 1	TRANSPOSE	DELAY
	+00	0

Links provide an easy way to create new sounds by combining the existing presets. Or, you can create your own custom stacked presets with up to 12 layers! We're talking LARGE sounds here. Of course Links can also be used when you just want to stack up two sounds.

As an example, let's stack two presets to create a big sound. Start with a preset you like, then go into the Links screen and start scrolling through the preset list while you play to hear both presets together. When you find a winner, simply Save the preset and you're finished!

- You can "Split" the keyboard up to 12 ways by using combinations of the Layers and Links.
- By adjusting the Velocity for the link, you can bring in the link by playing hard.
- Transposing the Link can radically change the sound.
- The delay parameter lets you create surprise effects, echoes or cascades of sound as you continue to hold the keys.

## Preset Tempo Offset

This function allows you to double or halve the Master Tempo as it applies to this preset. When playing or sequencing several presets in Multimode, the Master Tempo may be too fast or slow for one preset. Using this feature, you can adjust the tempo for the misbehaving preset. The Tempo Offset can use the **current tempo** or be set to **half** or **twice** the current tempo.

TEMPO OFFSET  
use current tempo x 2

## Audition Riff Selection



*Listening to the Riffs is a quick way to learn the sounds in Xtreme Lead. If a preset has hidden tricks or controllers, these will be shown off in the Riff.*

A Riff is a short pre-recorded musical phrase which can be anything from a single note to a full 16-track sequence as in the BEATS (bts) Riffs. This function allows you to assign a Riff to a Preset. The Preset Riff will be used when the front panel Audition button is pressed or when BEATS mode is set either to "On" or "Omni" in the main preset selection screen.

The Riffs themselves cannot be modified.

AUDITION SELECTION  
Plays:KEY-MiddleC

## Play Solo Layers

When constructing multilayer sounds it is often useful to turn off one or more of the layers so you can hear what you're doing! This feature allows you to temporarily solo individual layers or listen to them in any combination. This screen differs from the other Edit screens in that it is NOT saved with the preset. The values reset each time you exit the Edit menu.

Solo is activated by setting any layer to On (On = the layer is being Soloed). Any layers set to **On will play** and any layers set to **Off will be muted**. If all layers are set to Off, then Solo mode ends and all layers play normally. When you exit the Edit menu, all layers play normally.

PLAY SOLO LAYERS  
1: off    2: off    3: off    4: off

# Programming Tutorial

## Editing Presets

### Changing the Instrument

There is so much you can do with the Xtreme Lead it's impossible to describe it all. This chapter will give you some ideas for programming your own custom sounds and contains step-by-step instructions to help you get started. In order to get the most from this chapter, we recommend you actually try each example. Have fun!

One of the easiest ways to make a new preset is to edit an existing preset. This is also an excellent way of becoming familiar with Xtreme Lead. If you don't like what you hear, simply select a new preset, then Xtreme Lead reverts to the original sound. Changes are not permanent until you Save them (see "Saving a Preset" on page 191).

Let's experiment and modify a few parameters of an existing preset. We'll start with functions that have an obvious effect on the sound: Instrument Select, Tuning, and Chorus.

Changing the instrument is the easiest and most dramatic way to modify an existing preset.

#### ► To Change the Instrument for the Current Layer

1. Choose any cool preset, then press the Edit button.
2. Scroll through the Edit menu until you come to the Instrument page.



```
L1 INSTRUMENT      ROM:XLEAD
0307 bas:Fat Sun
```

3. Move the cursor down to the bottom line (using a Cursor button).
4. Use the Data Entry Control to change the instrument. This changes the instrument for the current layer (in this case it's L1).
5. Play the keyboard as you scroll through the various instruments.

## Changing the Tuning of an Instrument

### ► To Change the Instrument for any Layer in the Preset

6. Move the cursor back up to the first field in the first line (the layer).
7. Use the Data Entry Control to select the layer you want.



8. Repeat steps 3 and 4 for each selected layer. Find an instrument that sounds good when combined with the previous instruments selected.

With all these great instruments to work with, you really can't go wrong. Now let's play with the tuning.

Tuning the selected layer of the preset changes the pitch of the key on the controller. If the numbers are "00," it means that the instruments are tuned to concert pitch (A=440 Hz). The Coarse tuning value represents whole semitone intervals. The Fine tuning value shifts the pitch in 1/64 semitones (or 1.56 cents).

### ► To Tune the Instrument of the Current Layer

1. Scroll through the Edit menu until you come to the Tuning page.

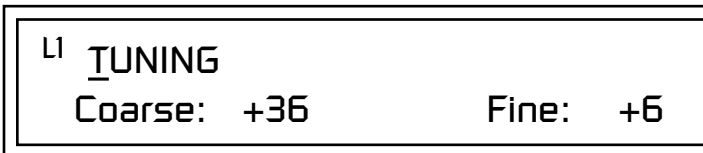

2. Move the cursor to the Coarse field (using the cursor button).
3. Set the value to +12 to shift the pitch up a whole octave. To shift the pitch in smaller units than a semitone, use the Fine field.

Try tuning one of the instruments to a perfect fifth above the other by setting the Coarse value to +7.

Tuning an instrument far out of its normal range completely changes the character of the sound. For example, if you tune a bass guitar up 2 octaves, it's going to sound rather petite. On the other hand, if you tune it down 2 octaves, you can probably rattle plaster off the walls! Experiment with radical pitch shifting. You'll be surprised at the results.

## Chorus



**WARNING:** Since it works by doubling the instruments, Chorus halves the number of notes you can play on Xtreme Lead.

This is an easy one. Chorus works by doubling the instruments and detuning them slightly. The larger the chorus value, the more detuning occurs. The Width parameter controls the stereo spread. A Width value of 0% reduces the chorus to mono, a value of 100% provides the most stereo separation. Chorus is useful when you want to “fatten up” a part quickly and easily.

### ► To Chorus a Layer

1. With the cursor on the top line of the display, turn the Data Entry Control until you find the Chorus page.
2. Use the cursor buttons to advance the cursor to the Chorus field (the first field in the bottom line of the display). Use the Data Entry Control to turn on chorus.

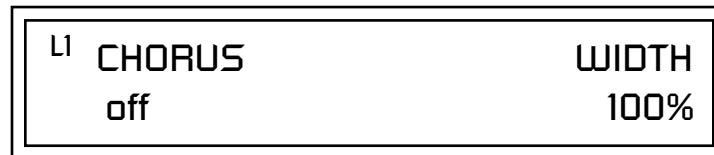

3. Select a Width value based on the amount of detuning you want. Smaller numbers mean less detuning, larger ones more.

You can select various amounts of chorusing for each of the instruments, just play around with the Chorus and Width parameter until you like what you hear.

## Volume Envelope

Every sound you hear, whether it’s a piano note, a drum, or a bell, has a characteristic volume curve or envelope. This Volume Envelope shapes the volume of the sound which grows louder or softer in various ways during the course of the sound. The volume envelope of a sound is one of the clues our brain uses to determine what type of sound is being produced.

An envelope shapes the sound or volume of the sound over time. The envelope generators in Xtreme Lead all have six stages to the contour: Attack 1, Attack 2, Decay 1, Decay 2, Release 1 and Release 2. When you press a key on the keyboard, the envelope goes through each of the first four stages, advancing to the next stage when the defined Level for each is reached. As long as you continue to hold the key down, the envelope continues through the first four stages holding at the end of the Decay 2 level until the key is released. When you release the key, the envelope jumps to the Release stages (no matter where the envelope is when you release the key) ending at the Release 2 level.

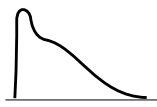

Piano

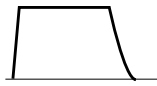

Organ



Strings

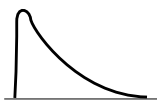

Percussion

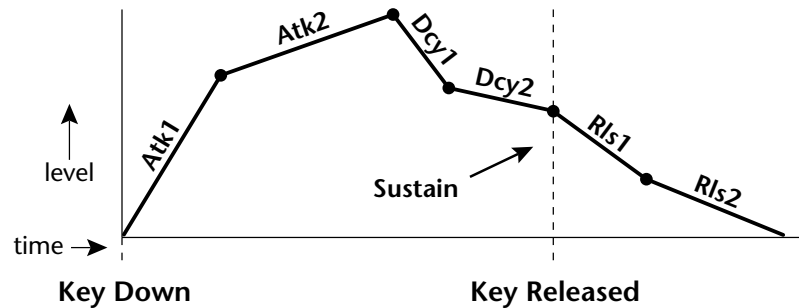

Every instrument in Xtreme Lead has its own predetermined volume envelope which is used when the Volume Envelope parameter is set to "factory." By setting the Volume Envelope to "time-based" or "tempo-based," we can reshape the instrument's natural volume envelope any way we want. By reshaping the volume envelope of an instrument, you can dramatically change the way the sound is perceived. For example, you can make "bowed" pianos or backward gongs. The diagrams to the left show the characteristic volume envelopes of a few common sounds.

In preparation for this experiment choose almost any of the standard organ presets which continues to sustain when the key is held down. Go to the Instrument page and set it to "None" on all layers except Layer 1. Now you're ready to play with the Volume Envelope.

### ► To Setup the Volume Envelope

1. Go to the Volume Envelope mode screen and set the Volume Envelope mode to "time-based."

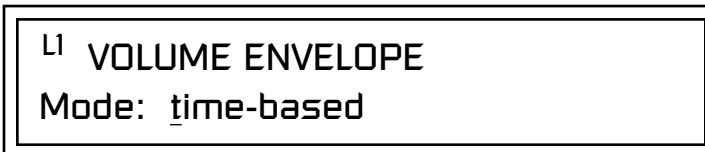

2. Now move on to the next screen to set the Volume Envelope parameters.

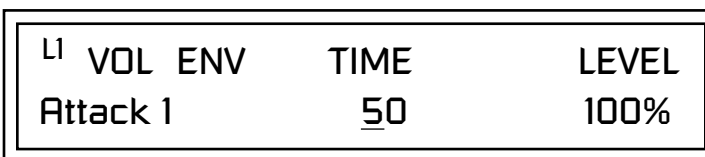

3. Increase the Attack 1 time value and play a note. The attack controls the time it takes for the sound to reach the Attack level when a key is pressed and held.



## Working with Filters

4. Move the cursor to the first field in the bottom line and use the cursor buttons to advance to the Release pages.
5. Increase the Release 1 and 2 times. Note the effect as you release the key on the controller. The Release stages controls the time it takes for the sound to die away when a note is released.

The filters make it possible to remove certain components of the sound. A low pass filter removes the high frequency components or put another way, it “lets the low frequencies pass.” A high-pass filter removes the low frequency components from the sound letting only the high frequencies pass. See “Xtreme Lead Filter Types” on page 141 for a complete list of Xtreme Lead’s filters and their descriptions.

In preparation for the next tutorial, select the Blank Preset. (Select the Preset Category and spin the Data Entry Control all the way to the left).

1. Go to the Instrument screen (Edit menu) and select Instrument #140 - Looped 1 This is a harmonically rich sound. Since filters work by removing or accentuating certain frequencies, we want to make sure that we have a lot of frequencies to start with.
1. Advance to the Filter Type screen using the Data Entry Control. Select the Classic 4th order filter.

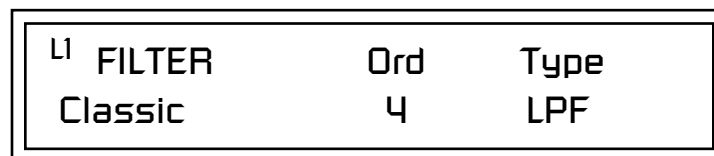

2. Go to the Filter Frequency and Q screen. Position the cursor in the Freq: field as shown in the following illustration.

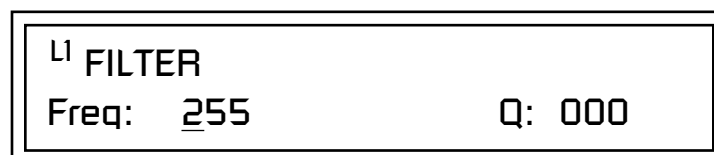

The Frequency parameter determines the filter cutoff frequency or the frequency the filter uses as the highest frequency allowed to pass.

If you play the keyboard now, you should hear the raw Looped Perc 1 sound. Slowly decrease the filter cutoff frequency value as you play the keyboard. The sound gets more and more dull as you remove more and more high frequencies from the sound. At some point, the sound completely disappears. (You have filtered out everything.) The chart on the following page illustrates what you just did.

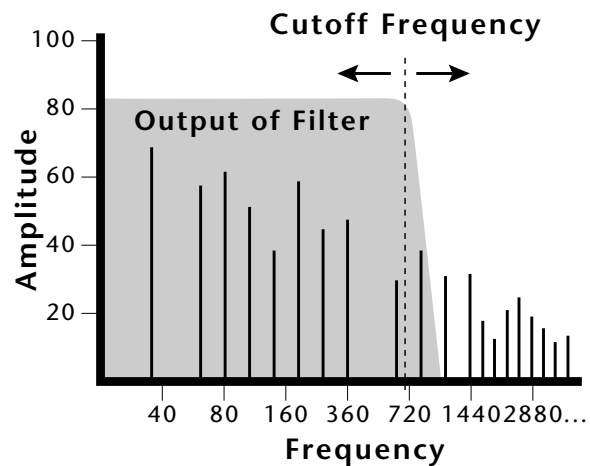

3. Open the filter back up to 255, then move the cursor to the Q field.
4. Set the Q to 10, then move the cursor back under the Freq value. As you change the frequency, notice that the sound now has a sharp, nasal quality. A high Q boosts or amplifies the frequencies at the cutoff frequency (Fc).
5. Reset the cutoff frequency to the lowest setting (0.08Hz) and the Q to 00.

### Adding the Filter Envelope

Now let's modulate the Filter Frequency with the Filter Envelope. The Filter Envelope is a device that can automatically change the filter frequency during the course of the note. Before we define the Filter Envelope, we need to patch the Filter Envelope to the Filter Frequency.

#### ► To Setup the Filter Envelope

1. Go to the PatchCord screen.

L1 PATCHCORD	#01
RlsVel -> AmpVol	+100

2. Move the cursor below the first field in the bottom line of the display. This is the Source field. Use the Data Entry Control to change the Source to "FiltEnv" as shown in the following illustration.
3. Advance the cursor to the next field. This is the Destination field. Use the Data Entry Control to change the destination to "FiltFreq."

4. Move the cursor to the last field in the line. This is the Amount field. The Amount field determines the amount of modulation applied. Set this value to "+100."

```

L1 PATCHCORD                #01
FiltEnv+  ->  FiltFreq      +100
  
```

This setup connects the Filter Envelope Generator to the Filter Cutoff as shown in the following diagram.

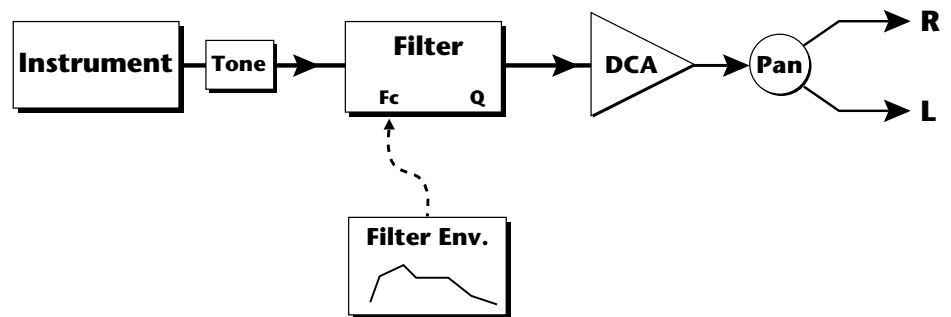

5. Now, return to the Filter Envelope Mode screen. Set the Mode to "time-based."

```

L1 FILTER ENVELOPE
Mode: time-based
  
```

6. Advance to the Filter Envelope parameter page.

```

L1 FILT ENV      RATE      LEVEL
Attack1         50         100%
  
```

7. Move the cursor underneath the time field and change the value to about +50. Now when you press a key the filter slowly sweeps up.

L1 FILT ENV	RATE	LEVEL
Attack1	50	+88%

8. Change the attack rate and note the change in the sound.
9. Set the envelope parameters as shown in the following table.

Envelope Phase	Time	Level %
Attack 1	40	65
Attack 2	65	100
Decay 1	80	85
Decay 2	25	50
Release 1	97	20
Release 2	73	0

With the above setup, the filter sweeps up, then Decays back down to the Decay 2 Level until you release the key. Then it sweeps down at the Release rates. Play with the envelope parameters for awhile to get a feel for their function. (If you're having trouble understanding the Envelope Generators, please refer to the Programming Basics section in this manual.)

### Changing Filter Types

Go back to the Filter Type screen shown below and move the cursor down the lower line of the display. Change the filter type while playing the keyboard. There are 50 different filter types.

L1 FILTER	Ord	Type
Aah-Ay-Eeh	6	VOW

These filters are extremely powerful and have been carefully crafted to offer maximum flexibility and musical control. You may want to change the Envelope (PatchCord) Amount, Q and/or the Filter Frequency to get the right sound for each filter and instrument. These three controls, coupled with the Filter Envelope, are perhaps the most important controls on any synthesizer. Take the time to learn how they interact with each other and you will be able to create sounds beyond imagination.

## Envelope Repeat

The Envelope Generator can also be made to repeat. When the envelope repeat function is On, the Attack (1&2) and Decay (1&2) stages will continue to repeat as long as the key is held.

### ► To Make the Filter Envelope Repeat:

1. Go to the Filter Envelope **Mode** screen shown below.
2. Move the cursor to the Mode field.



3. Turn the data entry control clockwise. The Mode field will change to Repeat as shown below.



4. Move the cursor to the on/off field and turn Envelope Repeat On.
5. Play a key on the keyboard. You should now hear the envelope repeating.
6. Go back to the envelope parameter page and adjust the Attack 1&2, and Decay 1&2 parameters. The repeating envelope cycles through these four stages as long as the key is held.

## Practice Modulating

- Try modulating the pitch with the Filter Envelope generator
- Use Velocity to modulate the Filter Envelope PatchCord or the Filter Frequency. This brightens the sound as you play harder.
- Program the LFO to modulate Filter Frequency and Volume (Patch-Cord screen).
- Modulate the LFO with the other LFO, with Velocity, and with the Modulation Wheel.
- Examine the Factory presets to learn how they're constructed. There are lots of cool synthesis tricks you can use in your own presets.
- Think of ten of your own modulation routings, then try them out. The key to learning Xtreme Lead is to experiment.

## Troubleshooting

A common source of confusion when working with the filter envelope is that the Attack or Release parameters might not seem to be working correctly. If you are not getting the expected result, try to analyze the situation. There will be many times when you will have to stop for a minute and think, "What am I trying to do and why isn't it working?" When this happens (and it will), don't panic. Troubleshooting is a normal part of the synthesis process. Simply examine the various parameters and try to be as analytical as possible as you solve the problem. The solution is usually simple (the filter is already wide open and can't open any more). Learning to play any instrument takes a little patience and practice.

Referring to the diagram below which shows the Xtreme Lead signal flow, notice that the DCA comes after the Filter. The DCA controls the final volume of the sound, so if the filter's release is longer than the release for the DCA, you won't hear it, because the DCA has already shut off the sound.

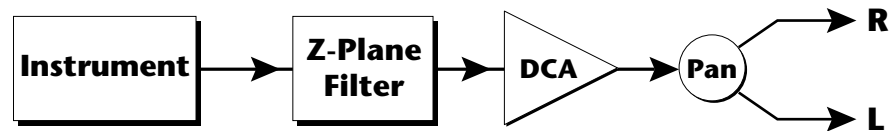

You're getting the general idea by now. Remember not to select a new preset before saving the current one or all your changes will be lost (the preset reverts to the last saved version). If you want to save your creation, select the Save/Copy menu and select a destination preset location for your masterpiece, then press Enter.

Because you can save your work, it's worth spending time to get the sound just right. When designing sounds you become an instrument builder as well as a musician. With Xtreme Lead you can design the custom radical instruments you've always wanted!

## Linking Presets

 See "Preset Links" on page 163 for more information.

Using the Link pages in the Edit menu is a quick and easy way to create new sounds. Use the Links to "layer" presets and to "split" a keyboard into sections containing different sounds.

### ► To Layer Two Presets

1. Select the first preset you want to layer.
2. Press the Edit button. Use the Data Entry Control to move through the screens until you find either the "LINK 1" or "LINK 2" screen shown below.

LINK 1	PRESET	XLEAD
off		

3. Move the cursor to the second line of the display. Select the preset you want to link with the preset you selected in step 1. Play the keyboard as you scroll through the various presets to hear the results.
4. If you want the link to be a permanent part of the preset, be sure to save the preset. Otherwise, simply change the preset to erase your work.

### ► To Create a Split Keyboard Using Links

1. Follow steps 1 through 4 above.
2. Press Enter and use the Data Entry Control to advance to the next page.

LINK 1	KEY	VEL
RANGE	<u>C</u> -2 B4	000 127

3. Set the keyboard range of the linked preset as desired.
4. Press Enter and use the Data Entry Control to go to the Key Range page (It's one of the first Edit menu pages).

L1	KEY:LO	FADE	HIGH	FADE
	C5	000	G8	000

5. Set the range of the original preset so it fills the remaining keyboard area. Save the preset.





# Effects

## Effects Overview

Xtreme Lead has two stereo effects processors. When playing presets one at a time, the two processors can be programmed as part of the preset. When the MIDI Mode is set to “multi,” the Proteus uses a global effects assignment (Master Effects). The diagram below shows how the effects are integrated into the signal path using a parallel effects send/return model, similar to a mixing console.

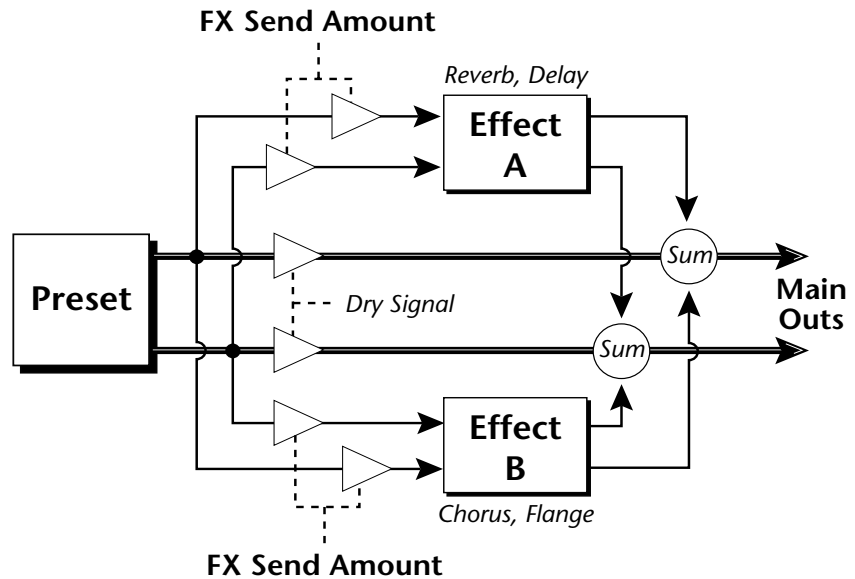

## The Effects Sends

On a mixing console you can control the amount of signal each channel sends to the effect bus. This allows each channel to be placed in a slightly different “sonic space” which creates an airy, open sound.

Xtreme Lead uses this basic concept, but works in a slightly different manner. There are four effects busses: Send1-Send4. Each preset or each MIDI channel (you determine which), can be directed to one of the four busses. Each effect processor has four Send Amounts which allow you to set the wet/dry mix on each of the four busses going into the effect. A setting of 0% is completely dry (no effect). A setting of 50% contains an equal mix of affected and normal (dry) signal.

The Effects Send is programmed for each layer in the Edit menu. These routings can be overruled in the Master menu *Mix Output* screen by changing the submix setting from “preset”, which uses the preset routing, to Send1-Send4. In the diagram below, MIDI channel 1 is programmed to obey the preset routing which in this case is Send 1.

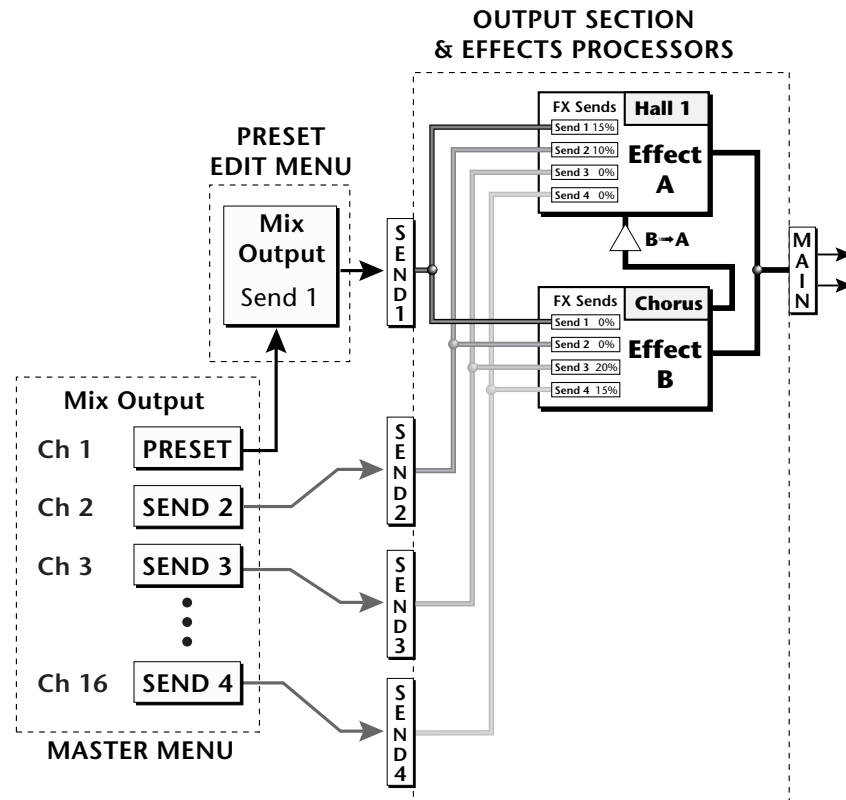

Individual layers or entire MIDI channels can be routed to any of the four busses.

The four Effect Sends allow you to get the most out of the two effect processors. For example, with Effect B set to an echo algorithm, you could route one MIDI channel to Send 3 and set the effect amount to 80%. Another MIDI channel could be routed to Send 4 with an effect amount of only 5%. This is almost like having two different effects!

The Mix Output function is also useful when sequencing since it lets you route specific MIDI channels (and thus sequencer tracks) to specific Sub outputs (on the back panel) where they can be processed with EQ or other outboard effects.

## Effect Types

### A Effect Types

Room 1-3  
Hall 1 & 2  
Plate  
Delay  
Panning Delay  
Multitap 1  
Multitap Pan  
3 Tap  
3 Tap Pan  
Soft Room  
Warm Room  
Perfect Room  
Tiled Room  
Hard Plate  
Warm Hall  
Spacious Hall  
Bright Hall  
Bright Hall Pan  
Bright Plate  
BBall Court  
Gymnasium  
Cavern  
Concert 9  
Concert 10 Pan  
Reverse Gate  
Gate 2  
Gate Pan  
Concert 11

Medium Concert  
Large Concert  
Large Concert Pan  
Canyon  
DelayVerb 1-3  
DelayVerb 4-5 Pan  
DelayVerb 6-9

### B Effect Types

Chorus 1-5  
Doubling  
Slapback  
Flange 1-7  
Big Chorus  
Symphonic  
Ensemble  
Delay  
Delay Stereo  
Delay Stereo 2  
Panning Delay  
Delay Chorus  
Pan Delay Chorus 1 & 2  
Dual Tap 1/3  
Dual Tap 1/4  
Vibrato  
Distortion 1 & 2  
Distorted Flange  
Distorted Chorus  
Distorted Double

### *Effect Parameters*

“A” Effect types contain Reverb and Delay effects. “B” Effect types contain Chorus, Flange and Distortion effects. There are 44 “A” effects and 32 “B” effects. In addition to the effect type, there are user adjustable parameters for each effect. The “A” effects have programmable Decay and High Frequency Damping. The “B” effects have user programmable Feedback, LFO Rate, and Delay Time.

### **Decay**

The Decay parameter is used when setting “A” type effects. Decay sets the length of time it takes an effect to fade out. When setting up reverb effects, Decay controls the room size and the reflectivity of the room. For larger room sizes and greater reflectivity, set the Decay value higher. When setting up delay effects, the Decay parameter controls how many echoes are produced or how long the echoes last. The greater the value, the more echoes and longer lengths of time.

The Decay value range is from 0 through 90.

### **High Frequency Damping**

The HF Damping parameter is used when setting “A” type effects. High Frequency energy tends to fade away first as a sound is dissipated in a room. The HF Damping parameter adjusts the amount of damping applied to the signal’s high frequency elements which, in turn, changes the characteristics of the room. Rooms with smooth, hard surfaces are more reflective and have less high frequency damping. Rooms filled with sound absorbing materials, such as curtains or people, have more high frequency damping.

The value range for High Frequency Damping is from 0 through 127.

### **Feedback**

The Feedback parameter is used when setting “B” type effects. The Chorus and Flange effects have a controllable feedback loop after the delay element. Feeding back a small amount of the signal intensifies the effect by creating multiple cancellations or images. Higher feedback values increase the amount of the Feedback loop.

The Feedback value range is from 0 to 127.

### **LFO Rate**

The LFO Rate parameter is used when setting “B” type effects. Both Chorus and Flange effects use a Low Frequency Oscillator (LFO) to animate the effect. LFO applied to a chorus effect creates the slight changes necessary for a realistic choral effect. Applied to a flanger effect, the LFO moves the comb filter notches and adds animation to the sound.

The LFO Rate value range is from 0 to 127.

### **Delay**

Flanging, chorus and echoes are all based on a delay line where the signal is delayed by some time period and then mixed back with the unaltered signal. This parameter specifies the how much time passes before you hear the delayed signal. On some effects, this value cannot be changed. In this case, the field contains a dash.

The Delay value range is from 0ms to 635ms.

## Effects Programmed in the Preset

Effects are normally programmed as part of the preset allowing you to have a different effect for each. This section describes how to program and modify Xtreme Lead's preset effects.

### ► To Program the Effects as Part of the Preset:

1. Press the Edit button. The LED illuminates and the Edit screen appears.
2. Use the Data Entry Control to select the FXA Algorithm screen.



3. Select an Effect. Do not select the "Master Effect" setting or the global effects set up in the Master menu will be used instead of the Preset Effect settings.
4. Use the Data Entry Control to select the FXA parameter screen.

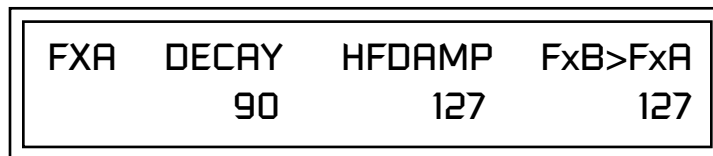

The FxB -> FxA parameter lets you route the B effect through the A effect. See "Effect B Into Effect A" on page 186.

5. Set the other effect parameters to your preference. Refer to the information in the last section for detailed descriptions of these parameters.
6. Use the Data Entry Control to select the FXB Algorithm screen.



7. Select an Effect. Do not select the "Master Effect" setting or the global effects set up in the Master menu will be used instead of the Preset Effect settings.
8. Use the Data Entry Control to select the FXB parameter screen.

## Master Effects

FXB	FEEDBK	LFORATE	DELAY
	127	127	635ms

9. Set the other effect parameters to your preference. Refer to the information in the last section for detailed descriptions of these parameters.
10. Save the preset. The programmed effects setting will be saved along with the preset.

You might want the effects to be programmed on a global basis when in Omni or Poly modes. You could choose your favorite reverb, for example, and have it applied to any preset you select.

When playing single presets, the effects are normally programmed as part of the preset. In Multimode, the Master effects are used, since there are only two effect processors to serve 16 MIDI channels.

### ► To Program the Master Effects

1. Press the Master menu button. The LED illuminates and the Master screen appears.
2. Use the Data Entry Control to select the FXA Algorithm screen.

FXA ALGORITHM
Lg Concert Pan

3. Select an Effect.
4. Use the Data Entry Control to select the FXA parameter screen.

FXA	DECAY	HFDAMP	FxB>FxA
	90	127	127

The FxB -> FxA parameter lets you route the B effect through the A effect. See "Effect B Into Effect A" on page 186.

5. Set the other effect parameters to your preference. Refer to the information in the last section for detailed descriptions of these parameters.
6. Use the Data Entry Control to select the FXB Algorithm screen.



7. Select an Effect.
8. Use the Data Entry Control to select the FXB parameter screen.

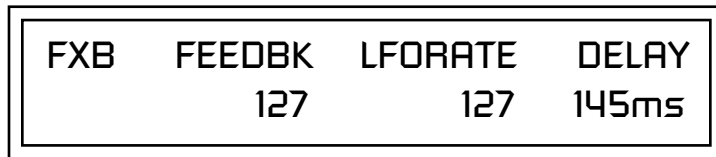

9. Set the other effect parameters to your preference. Refer to the information in the last section for detailed descriptions of these parameters.
10. Press the Edit menu button. The LED illuminates and the Edit menu displays the last screen used.
11. Use the Data Entry Control to access the FXA Algorithm page and select "Master Effect A."



*The MIDI mode (Master Menu) must be set to Omni or Poly mode in order to select the effects in the preset.*



12. Repeat step 11 for the FXB Algorithm
13. Save the preset. The Master effects routing will be saved along with the preset.

## Effects Mode

This control provides a true bypass of the effects engine. Bypass is a useful feature if you are using external effects at the mixing console and want to turn the effects off for all presets.

### ► To Bypass the Effects:

1. Press the Master menu button. The LED lights and the last Master parameter screen used is displayed.
2. Use the Data Entry Control to select the Effects Mode screen.

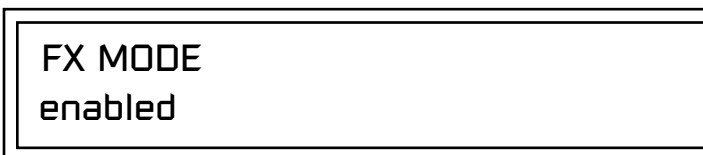

3. Use the cursor button to advance the cursor to the bottom line in the screen.
4. Use the Data Entry Control to change the value.
5. Press the Enter key to save the settings.

The Effects Mode values are “enabled” and “bypassed.” Enabling the Effects Mode turns on effects. Selecting “bypassed” turns off the effects.

## Flexible Effects Control

The effects processor controls are very flexible. The effects can be controlled in three different ways to suit your personal preference and to adapt to different situations.

When in Omni or Poly mode, effects are normally programmed as part of the preset. In Multi mode, the two effects processors can be controlled using the Master settings or by using the effects settings of a preset on a specific MIDI channel. Effects can be programmed in the following ways:

1. **Programmed as part of the preset when playing single presets (Omni or Poly Modes).**
2. **Programmed from the Master Effects Section when playing either single presets (preset Effect Type set to “Master”) or when in Multi Mode.**
3. **Programmed from the designated control preset when in Multi Mode.**

 You can create special “Effects Presets” which are assigned to the FX Multi mode Control channel, then use standard MIDI Program Change commands to switch effects during sequence playback.



Refer to the following diagram for a look at how effects are programmed.

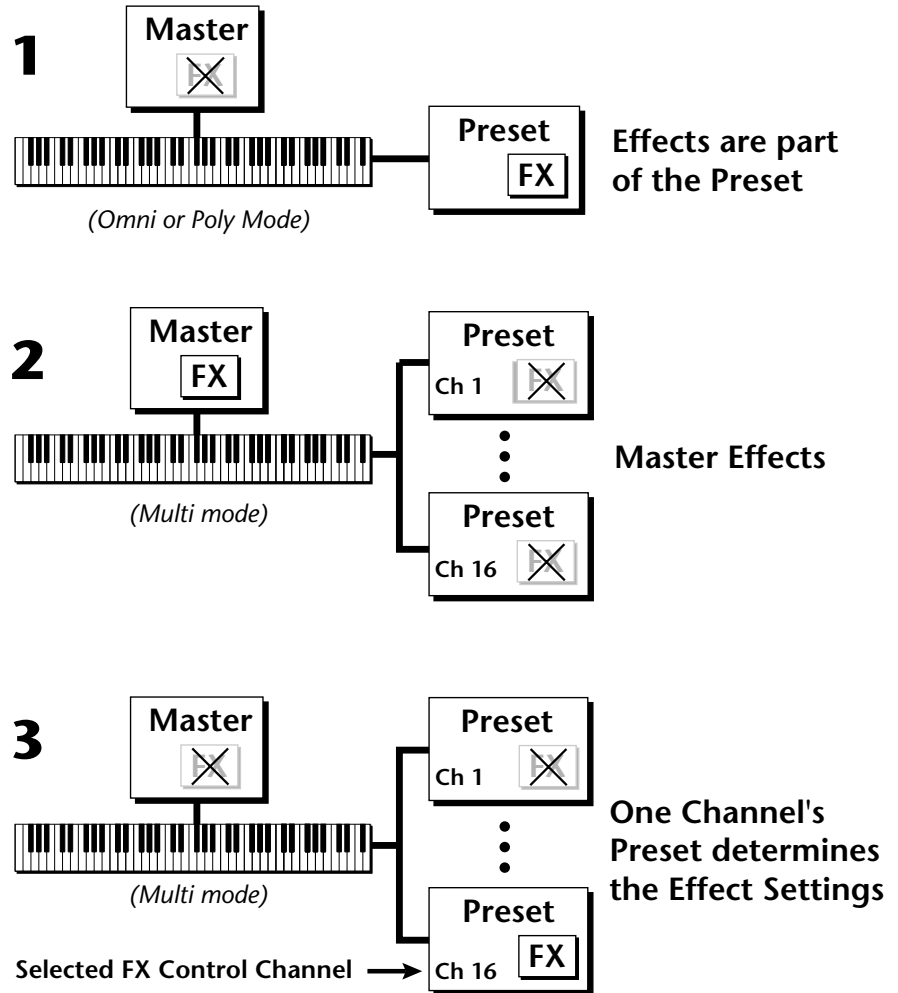

► **To Program the Effects Globally for all Presets in Multi Mode:**

1. Press the Master menu button. The LED illuminates and the Master menu screen appears.
2. Use the Data Entry Control to select the MIDI mode page. Choose "multi" for the mode.

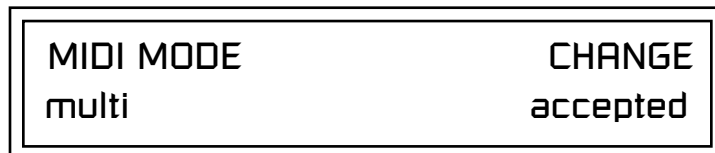

3. Move the cursor to the Multi mode Effects Control page using the Data Entry Control.

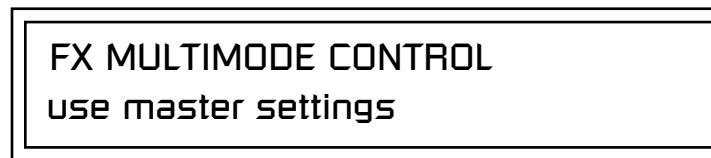

4. Set the Effect Control channel to *use master settings* using the Data Entry Control.
5. Press the Enter key to save the settings and return to the main screen.

### Using the Effects Channel Settings in Multi Mode

In Multi mode, the two effects processors can be controlled from the Master Effects settings or they can follow the effects settings of the preset on a special MIDI channel. The effect settings on this special channel will be applied to all the other MIDI channels. This allows the effects to be changed during a sequence simply by changing the preset on a specified MIDI channel.

#### ► To Program the Effects by Channel Number in Multi Mode

1. Press the Master menu button. The LED illuminates and the Master menu screen appears.
2. Use the Data Entry Control to select the MIDI mode page. Choose “multi” for the mode.
3. Move the cursor to the Multi mode Effects Control field using the Data Entry Control
4. Set the Effect Control to “preset on Channel #” (where # is replaced by the actual channel number from 1 through 16) using the Data Entry Control.
5. Press Enter to save the settings and return to the main screen.

### Effect B Into Effect A

The output of effects processor B can be routed into effects processor A. This connects the effects in series instead of their normal parallel configuration. Two effects connected in series sound very different than the same two effects in parallel. For example, a chorus patched through reverb can turn a bland string section into a lush wall of sound. The B →A amount can also be controlled for even more flexibility.

#### ► To Send the Output of Effect B through Effect A:

In this example, 100% of Effect B will be sent into Effect A.

1. Access the FXA parameter screen (in either the Master or Edit menus) that contains the FXB →FXA parameter.

FXA	DECAY	HFDAMP	FxB>FxA
	127	127	127

- Set this amount to 127. Press the cursor button to return the cursor to the top line in the display.
- Use the Data Entry Control to select the FXA submix routing parameter screen.

FXA SEND AMOUNTS	1: 10%
2: 20%	3: 30%
	4: 40%

- Press the cursor buttons to advance the cursor to the Main field.
- Set the Main send amount to any amount other than zero.
- Press the cursor button again to return the cursor to the FXA title. Use the Data Entry Control to advance to the FXB Algorithm page.
- Select an effect.
- Advance to the FXB submix routing page and set the Main FXB send percentage to zero.
- Play the keyboard and you should hear the B Effect running through Effect A. This patch is shown below.

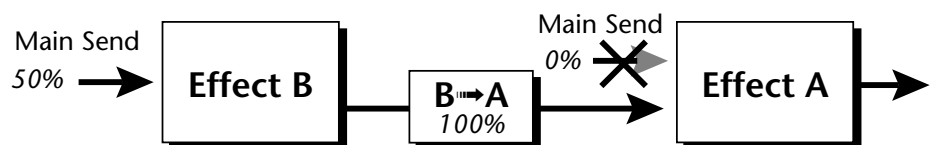

## General Effect Descriptions

### Reverb

Reverberation is a simulation of a natural space such as a room or hall. The reverb algorithms in Xtreme Lead simulate various halls, rooms and reverberation plates. In addition, there are several other reverb effects such as Gated Reverbs, Multi Tap (early reflections), Delay and Panning effects. There are two adjustable parameters on the reverb effects - Decay Time and High Frequency Damping.

Decay time defines the time it takes for the reflected sound from the room to decay or die away. The diagram below shows a generalized reverberation envelope.

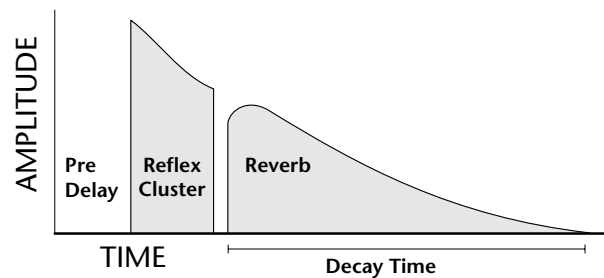

After an initial pre-delay period, the echoes from the closest walls or ceiling are heard. These first echoes, or the early reflection cluster, vary greatly depending on the type of room. Roughly 20 milliseconds after the early reflection cluster, the actual reverberation begins and decays according to the time set by the Decay Time parameter.

High frequency energy tends to fade away first as a sound is dissipated in a room. The High Frequency Damping parameter allows you adjust the amount of high frequency damping and thus change the characteristics of the room. Rooms with smooth, hard surfaces are more reflective and have less high frequency damping. Rooms filled with sound absorbing materials such as curtains or people have more high frequency damping.

#### General Descriptions of the Reverb Types

**Room:** Programs simulate small rooms with high frequency absorption caused by drapes and furniture.

**Plates:** Simulates plate type reverbs with their tight, dense, early reflections and sharp reverb buildup.

**Hall:** Presets recreate the open, spacious ambience of large concert halls.

**Gated Reverbs:** Add ambience only while the original signal is still sounding. As soon as the signal falls below a threshold, reverb is cut off.

**Delay:** Programs can be used to create echo and doubling effects.

**Multi Tap:** Programs consist of the reflection cluster only without the reverb decay.

## Chorus

The function of a chorus device is to thicken the sound or to make one voice sound like many. This effect is usually created by mixing one or more delayed versions of the signal with the original. The delay times used are too short to be perceived as an echo, but long enough so that comb filtering does not occur. In addition, the delay time is varied via a low frequency oscillator to simulate the random differences which occur when multiple instruments are playing together. A slight amount of feedback improves the effect by creating multiple images of the sound as it recirculates again and again.

All the choruses are true stereo using two separate delay lines controlled by a single set of controls. The delay times are slightly different for each channel and the LFO phase is inverted on one channel to help contribute to the overall chorus effect. The LFO Rate and Depth settings are critical to achieving a realistic effect, with faster LFO rates generally requiring less LFO amount and vice-versa.

## Doubling

When a copy of a sound delayed by about 26 milliseconds is added back to the original, two audio images are perceived by your brain. When the delayed image is slightly varied or modulated, the illusion of two voices is created.

## Slapback

Slapback is a single short echo in the range of 50-60 milliseconds. A sound delayed by this length of time is perceived as a discrete and separate image which is useful for a thickening effect or as a pre-delay for reverb simulating a hard, reflective surface such a gymnasium wall.

## Stereo Flanger

A flanger consists of a short audio delay line whose output is mixed together with the original signal. Mixing the delayed and original signals results in multiple frequency cancellations called a comb filter. Since the flanger is a type of filter, it works best with harmonically rich sounds.

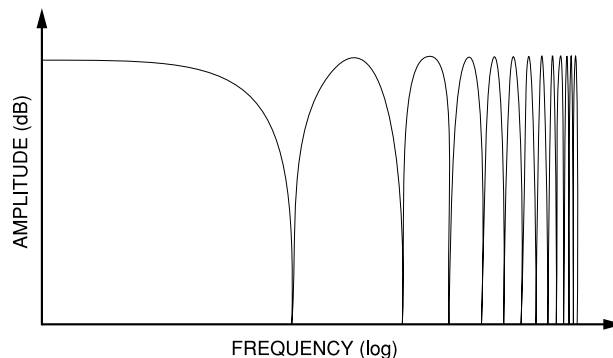

This is the frequency response of a Comb Filter.

Flanging was originally created using two tape recorders playing identical recordings. By exactly synchronizing the two decks and then slowing the speed of one by grasping the tape reel flanges, the flanging effect was born.

The Xtreme Lead flanger is a stereo device consisting of two separate delay lines controlled by a single set of controls. A Low Frequency Oscillator (LFO) varies this initial delay setting, changing the frequency of the notches and adding animation to the sound. LFO Rate controls the rate of change and LFO Depth controls how much the LFO changes the delay.

The Feedback control sends some of the delayed signal through the delay line again. When feedback is used the comb filter notches are deepened.

### *Delay*

Delay is an effect which can be used for doubling, reverb pre-delay, or echoes.

Delay Time is variable from 0-635 mS and controls the time between echoes. Feedback and determines how long the echoes continue sounding. "Infinite" delay effects are also possible without the risk of runaway.

### *Stereo Delay*

Similar to delay except that the delay line outputs a stereo signal from the mono input. The two output signals are a few milliseconds apart to create a stereo image. The delay times are variable from 0-635 mS.

### *Panning Delay*

A panning delay is similar to the normal delay lines except that the echoes bounce back and forth between the two stereo speakers.

### *Dual Tap*

These are delay lines where the signal is "tapped off" at two unevenly spaced locations. When feedback is used, multiple complex echoes are produced. The fraction in some of the algorithm names (i.e. 1/3, 1/4) refers to the time ratio between the taps.

### *Vibrato*

Basically, this a delay line modulated by an LFO, but with none of the original signal added in. The LFO modulation creates a Doppler shift and a resultant cyclical pitch shift. The vibrato created in this manner sounds very different than vibrato created by frequency modulating the sample.

### *Distortion*

Distortion uses a technique called "soft-clipping" to create additional harmonics in the signal. As the level increases, the top of the waveform becomes somewhat squared. As the level increases further, it transforms into a true square wave.



Soft clipping gradually squares the edges of the waveform as the amplitude is increased.

# Save/Copy Menu

## Saving a Preset

 Each time you change a preset parameter, the Save/Copy button LED illuminates reminding you to save your work.

The Save/Copy menu is used to save changes to a preset and to copy data between presets. When in “Quick Edit” mode, this menu always defaults to the “Save to Preset” page of this menu with the cursor on the second line. You can use the Data Entry Control to navigate to other pages that support copying information.

Any time you make a change to a preset, either using the Edit menu or by changing the Controller Knobs in Quick Edit mode, you must save the preset in order for the change to become permanent. When you save a preset it erases any existing preset information in that location. Make sure that the destination location does not contain preset information you want to keep.



```
SAVE PRESET to      User
0201 Destination Preset
```

### ► To Save a Preset

1. Press the Save/Copy menu button.
2. Move the cursor to the bottom line on the display.
3. Select the new preset location using the Data Entry Control.
4. Press the Enter/Home button.

## Copying Information

The Copy operations let you copy information from any preset or layer to any other preset or layer. To use the copy command, first select the preset or layer to which you want to copy (the destination location). Then, from the copy screen, select the preset or layer you want to copy to the currently selected location (the source location). Using the copy commands you can copy preset, layer, PatchCord and arpeggiator information.

### Copy Preset

The Copy Preset command lets you copy all of the preset information from one location into the preset of the current location. The preset information in the source location (the preset location from which you want to copy) is not deleted from the original location, just copied to the destination location.



#### ► To Copy a Preset

1. Select the Preset you want to copy information *into*.
2. Press the Save/Copy menu button.
3. Select "Copy Preset from" using the Data Entry Control.
4. Select the preset you want to copy using the Data Entry Control. The ROM Bank, Preset Number, Bank Number, Category and Preset Name fields are all selectable.
5. Press the Enter/Home button.
6. A warning screen appears asking you to confirm once more. Press the Enter/Home button to copy the selected preset into the current location.

 All the Sound Navigator features work when using the Copy functions.

### Copy Layer

The Copy Layer command lets you copy any layer information from one preset into any layer of the current preset location. The layer information in the source location (the layer location from which you want to copy) is not deleted from the original location, just copied to the destination location.

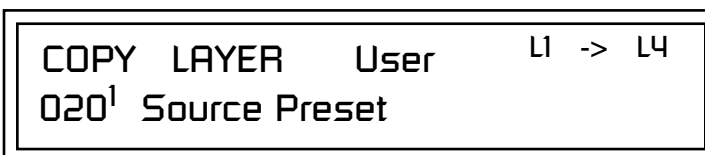



*Copy  
PatchCords*

► **To Copy a Layer**

1. Select the Preset and Layer you want to copy information into.
2. Press the Save/Copy menu button.
3. Move the cursor to the bottom line on the display.
4. Select the preset location using the Data Entry Control, of the preset containing the information you want to copy into the current preset.
5. Move the cursor to the top line in the display.
6. Select the layer of the source preset in the first field on the right.
7. Select the destination layer in the second field.
8. Press the Enter/Home button.

The Copy PatchCord command lets you copy the patchcord settings from one layer of the preset location into the current layer of the current preset location. The preset information in the source location (the preset location from which you want to copy) is not deleted from the original location, just copied to the destination location.

```
COPY CORDS   User   L1 -> L4
0201 Source Preset
```

► **To Copy a PatchCord**

1. Select the Preset and Layer you want to copy information into.
2. Press the Save/Copy menu button.
3. Move the cursor to the bottom line on the display.
4. Select the preset location using the Data Entry Control, of the preset containing the information you want to copy into the current preset.
5. Move the cursor to the top line in the display.
6. Select the layer of the source preset in the first field on the right.
7. Select the destination layer in the second field.
8. Press the Enter/Home button.

## Copy Preset PatchCords

The Copy Preset PatchCord command lets you copy the preset patchcord settings from one preset location into the current preset location. The preset information in the source location (the preset location from which you want to copy) is not deleted from the original location, just copied to the destination location.

```
COPY PRESET CORDS      User
0201 Source Preset
```

### ► To Copy a Preset PatchCord

1. Select the Preset you want to copy information into.
2. Press the Save/Copy menu button.
3. Move the cursor to the bottom line on the display.
4. Select the preset containing the information you want to copy.
5. Press the Enter/Home button.

## Copy Arpeggiator Settings

This function lets you copy the Arpeggiator settings from any ROM or RAM preset location into the current RAM (User) preset.

```
COPY ARP SET from XLEAD
0520 syn: Syn Chaos
```

### ► To Copy the Arpeggiator Settings

1. From the main display, select the User Preset you want to copy the Arp setting *into*.
2. Press the Save/Copy menu button.
3. Move the cursor to any of the fields on the bottom line on the display.
4. Use the Data Entry Control to select the preset you want to copy *from*.
5. Press Enter when you have made your selection. *The Enter LED is flashing indicating that XL-1 is waiting for your response.*
6. The Arp Settings are copied into the current preset.

## Copy Arpeggiator Pattern

This function lets you copy the Arpeggiator pattern from any ROM or RAM preset to any RAM (user) pattern.



COPY ARP PAT from XLEAD  
96<sup>1</sup> TRANCED

### ► To Copy the Arpeggiator Pattern

1. Press the Save/Copy menu button.
2. Move the cursor to any of the fields on the bottom line on the display.
3. Use the Data Entry Control to select the preset you want to copy *from*.
4. Press Enter when you have made your selection.



Overwrite pattern:  
00<sup>0</sup> No Control

5. Press Enter, The Arp Pattern is copied into the selected User Pattern.

## Copy Preset Bank

The Copy Preset Bank command lets you copy an entire bank from any ROM or RAM bank location to any RAM (user) bank. This function can be especially useful after installing a new sound SIMM.

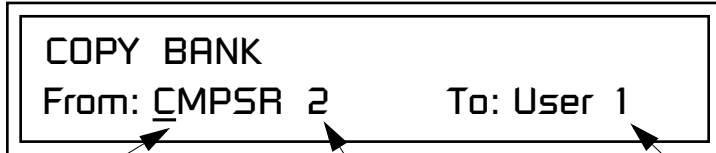

COPY BANK  
From: CMPSR 2 To: User 1

ROM or RAM Preset Location      Bank No.      Destination Bank No.

### ► To Copy a Preset Bank

1. Press the Save/Copy menu button.
2. Move the cursor to the "From" field on the bottom line on the display.
3. Use the Data Entry Control to select the preset bank you want to copy *from*.
4. Move the cursor to the "To" field on the bottom line on the display.
5. Use the Data Entry Control to select the User preset bank you want to copy *into*.
6. Press the Enter/Home button to overwrite the bank.

# Multisetups

A Multisetup is a group of parameters that you might associate with a particular sequence or song. It is like a “snapshot” of the current MIDI channel configuration of the module. There are 64 setups numbered 0-63. All Multisetups are user programmable.

## A Multisetup includes ALL the following parameters:

- Preset/Volume/Pan/Arp/Beats assignments for each of the 16 MIDI channels.
- Multisetup Name
- ALL Arp/BEATS Menu Parameters
- ALL Master Menu Parameters  
except...
- MIDI Program Change->Preset map
- User Key Tuning Tables

## Restoring Multisetups

Xtreme Lead contains 64 Multisetup locations. These are all User locations which you can use to store your own Multisetups.

Multisetups can also be restored using a MIDI Bank Select command.  
**Select: cc00 = 80, cc32 = 00, (dec)** then send a **Program Change** command corresponding to the Multisetup you wish to select.

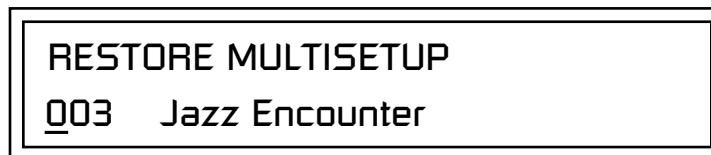

### ► To Restore (Select) a Multisetup:

1. From the Save/Copy menu, scroll to the Restore Multisetup screen using the data entry control. The menu page most recently selected since powering up Xtreme Lead will be displayed. The cursor appears below the first character of the screen heading on line one.
2. Press either cursor button to move the cursor to the bottom line of the screen.
3. Now, use the Data Entry Control to select a Multisetup. The Enter LED will be flashing.
4. Press the Enter button to load the selected Multisetup.

## Multisetup Name

Multisetups can be named to make it easier to remember their purpose.

1. Scroll to the "Setup Name" screen (shown below) using the Data Entry Control.

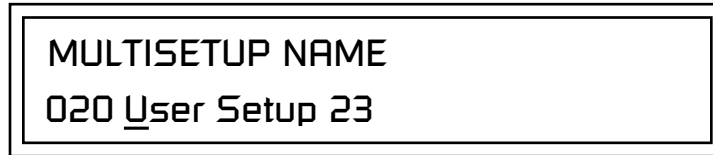

2. Press either cursor button to move the cursor to the bottom line of the screen.
3. Change the characters using the data entry control. Change the cursor position using the cursor buttons.
4. Press Enter or move the cursor to the top line when you're finished naming the multisetup.

### ► To Save a Multisetup:

1. Set the Preset, Volume, Pan, Arp and Beats settings the way you want them for all channels. Set the Master menu parameters the way you want them.
2. Press the Save/Copy button, then scroll to the "Save Setup" screen (shown below) using the Data Entry Control.



3. Press either cursor button to move the cursor to the bottom line of the screen.
4. Now, use the Data Entry Control to select the destination location. The Enter LED will be flashing.
5. Press the Enter button to save the Multisetup.

## Saving Multisetups

## Create Random Preset

This is a great feature which creates a new preset using portions of the ROM presets as source material. By merging random presets, really great sounding presets can be generated with ease. Use this feature to generate wild new sounds, get new programming ideas or just for fun.



*Examine interesting presets to learn how they work using the Edit menu.*

### ► To Create a Random Preset

1. Press the Save/Copy menu button.
2. Move the cursor to the bottom line on the display and press Enter.
3. A new random preset will be created.
4. Don't like the sound? Press Enter again and a new random sound will be generated.

## Copy User Bank to Flash

This is a special purpose function to be used with the Flash sound authoring feature. Flash Sound SIMMs created on an EOS Ultra sampler can be used as a custom Xtreme Lead bank. Presets are then created in a User bank. When the bank of presets is finished, it can be copied, using this function, to the Flash SIMM. Flash SIMMs contain two separate memory locations. One of these memories contains the sound samples and the other memory can hold four banks of 128 presets.

**WARNING: dangerous voltages are exposed inside Xtreme Lead!** Make sure power is completely disconnected from Xtreme Lead before removing the top panel. Replace the top panel before restoring power to the unit. The two sound SIMM sockets in Xtreme Lead, marked 0 and 1, are located behind the controller knobs on the circuit board. **The destination Flash SIMM must be placed in SIMM socket 1.**

**COPY USER BANK TO FLASH**  
From: User<sup>0</sup>      To: Flash<sup>2</sup>

### ► To Copy a User Bank to Flash

1. Make sure a Flash SIMM is inserted into the extra Xtreme Lead SIMM socket.
2. Press the Save/Copy menu button.
3. Rotate the Data Entry Control to select the "Copy User Bank" function shown above.
4. Move the cursor to the "From" field and select the User bank that you want to copy to the Flash SIMM.
5. Move the cursor to the "To" field and select the Flash bank that you want to contain the User bank.
6. Press Enter. The Enter LED will flash and the screen below appears.

**Press ENTER to Overwrite  
Flash SIMM Presets**

7. Press Enter again to confirm. The following screen appears:

**COPYING USER BANK TO FLASH  
Done. Please Reboot Now.**

8. The Flash presets cannot be used until Xtreme Lead is rebooted (power off then on). Reboot the Xtreme Lead and verify that the new Flash bank has been properly copied.



*If there is no Flash SIMM in the unit, the error message, "Requires Flash SIMM" will be displayed.*

## Rename Flash SIMM



TheFlash ID is the MSB of the MIDI Bank Select command used to select the Sound Bank.



If there is no Flash SIMM in the unit, the error message, "Requires Flash SIMM" will be displayed.

This utility allows you to rename the Flash SIMM and change its ID number. Flash SIMMs can have any five letter name you choose. Each Flash SIMM in a Xtreme Lead unit must have a unique ID number (106-119).

The field in the upper right corner selects between multiple Flash SIMMs. If only one Flash SIMM is installed, the field cannot be modified.

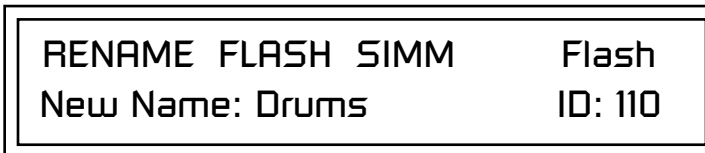

1. Make sure a Flash SIMM is inserted in a Xtreme Lead SIMM socket.
2. Press the Save/Copy menu button.
3. Rotate the Data Entry Control to select the "Rename Flash SIMM" function shown above.
4. Move the cursor to the "New Name" field and rename the SIMM using the Data Entry Control to select the letter and the cursor keys to select the position.
5. Set the Sound ID number for the SIMM. It doesn't matter which number you choose as long as the same number isn't used in another SIMM.
6. Press Enter. The following screen appears and the Enter LED will be flashing.

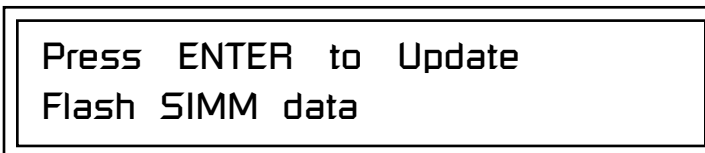

7. Press Enter again to confirm or any other button to abort. The following screen appears:

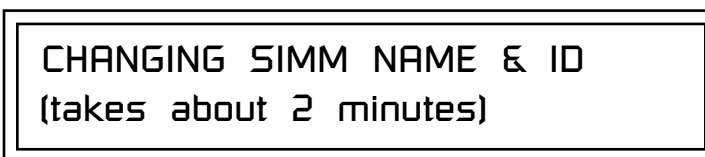

8. The Flash presets cannot be used until Xtreme Lead is rebooted (power off then on). Reboot the Xtreme Lead and verify that the new Flash bank has been properly renamed.



## Duplicate Flash

This utility allows you to duplicate Flash SIMMs using Xtreme Lead. Both Sound and Preset data is copied when a Flash SIMM is duplicated. A factory sound SIMM cannot be copied using this utility.

**WARNING: dangerous voltages are exposed inside Xtreme Lead! Make sure power is completely disconnected from Xtreme Lead before removing the top panel. Replace the top panel before restoring power to the unit.**

The two sound SIMM sockets in Xtreme Lead are marked 0 and 1. These are located behind the controller knobs on the circuit board. The Flash SIMM you want to copy **MUST** be placed into SIMM Socket 0. The destination Flash SIMM must be placed in SIMM socket 1.

DUPLICATE SLOT 0 FLASH  
Start



*If there are no Flash SIMMs in the unit, or if the SIMMs are in the wrong slots, an error message will be displayed.*

1. Make sure the two Flash SIMM are located in the required Xtreme Lead SIMM sockets.
2. Press the Save/Copy menu button.
3. Rotate the Data Entry Control to select the "Duplicate Flash SIMM" screen shown above.
4. Move the cursor to the bottom line and press Enter. The following screen appears and the Enter LED will be flashing.

Press ENTER to overwrite  
the Flash SIMM in Slot 1

5. Press Enter again to confirm or any other button to abort. The following screen appears and the SIMM is copied.

DUPLICATING SLOT 0 -> SLOT 1  
(Takes about 5 minutes)

6. When Xtreme Lead has finished duplicating the SIMM, turn power off, remove the copied SIMM, then reboot. That's it!



# Appendix

## Front Panel Knob Functions

 The Front Panel Knobs can be reprogrammed for each preset and stored in any of the User Presets. The functions shown here are the factory programmed settings.

This section provides some of the more technical information about XL-1. In this appendix, you will find information about velocity curves, MIDI commands and PatchCord charts.

The front panel knob functions are standardized for most of the factory presets. The typical functions of the controller knobs are described below. Match the controller knobs on your MIDI controller to the Realtime Controller Assignments in the Master menu to control these functions.

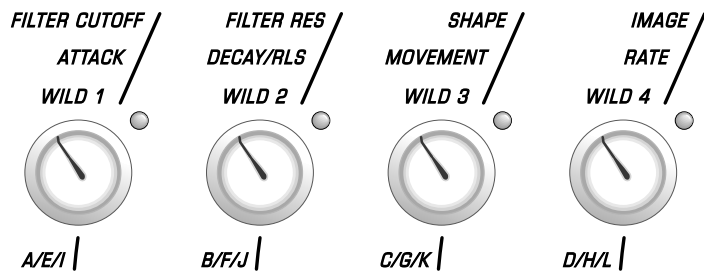

- Filter Cutoff** ..... Filter Frequency
- Filter Res** ..... Filter Resonance
- Shape** ..... Volume or Filter Envelope Attack
- Image** ..... Pitch/Glide/Chorus Amount/Layer Volume
- Attack** ..... Volume Envelope Attack Rate
- Decay/Release** ..... Volume Envelope Decay or Release Rate
- Movement** ..... LFO Amount
- Rate** ..... LFO Rate
- Wild 1** ..... BEATS = Busy +/-, Non-BEATS = Filt Env Attack
- Wild 2** ..... BEATS = Variation, Non-BEATS = Filt Env Release
- Wild 3** ..... BEATS = Xpose Grp 1, Non-BEATS = Arp Velocity
- Wild 4** ..... BEATS = Xpose Grp 4, Non-BEATS = Arp Gate

## Presets

### *XL-1 Preset Categories*

The XL-1 presets are organized in categories according to the types of sound. Listed below are the categories and their three letter prefixes:

<b>arp:</b> Arpeggiated	<b>air:</b> Wind noise instrument
<b>bas:</b> Bases	<b>bel:</b> Bells
<b>bpm:</b> Synchro-sonic, clocks	<b>bts:</b> BEATS presets
<b>edg:</b> Edgy, cutting	<b>hit:</b> Shorter
<b>key:</b> Keyboard instrument, organ	<b>kit:</b> Drum kit
<b>led:</b> Leads	<b>nse:</b> Noises
<b>pad:</b> Sustained, pad-like	<b>prc:</b> Percussion
<b>raw:</b> Playable, vanilla	<b>sfx:</b> Sound Effects
<b>syn:</b> Complex, harmonically rich	<b>vox:</b> Vocals
<b>wal:</b> Dense, harmonically complex	

## Preset Listing

### User Bank 0, XLEAD Bank 0

- |                      |                      |                       |
|----------------------|----------------------|-----------------------|
| 0. syn:ORiON         | 43. syn:Weezeled     | 86. bas:Sven Analog   |
| 1. bts:Trancer       | 44. syn:Post Modern  | 87. bas:B-Acer mono   |
| 2. raw:Basic Saw     | 45. syn:JourneyMan   | 88. bas:Henny-P mono  |
| 3. bpm:Boogy Synth   | 46. syn:Skouls       | 89. bas:Pinhead       |
| 4. arp:X-light       | 47. syn:Kyng Doam    | 90. bas:SlappyFlange  |
| 5. edg:BoXT mono     | 48. syn:Nordica Comp | 91. bas:FinGruzzler   |
| 6. wal:Raverotic     | 49. syn:Geaxoils     | 92. bas:Goin'Lo mono  |
| 7. bas:1 Shot mono   | 50. syn:DarkShadows  | 93. bas:Go Long mono  |
| 8. pad:Strings Box   | 51. syn:AudKlav      | 94. bas:M-Deep mono   |
| 9. led:Wet           | 52. syn:Syn Chaos    | 95. bas:CReePeR mono  |
| 10. air:Bat Pann     | 53. syn:R&B Syncomp  | 96. bas:KEVLAR mono   |
| 11. bts:Perception   | 54. syn:Octivate     | 97. bas:Mango         |
| 12. kit:Hide & Seek  | 55. syn:Smooth Saw   | 98. bas:JUMPUP mono   |
| 13. bas:SquareV mono | 56. syn:Saint-A.     | 99. bas:Acid Vox      |
| 14. nse:DSTRUCTOR    | 57. syn:Grindin Me!  | 100. bas:ReedBass     |
| 15. arp:Glory        | 58. syn:Calmer       | 101. bas:FuzzBizz     |
| 16. hit:Hittite      | 59. syn:Zionate      | 102. bas:Ventolator   |
| 17. bpm:UnderClasS   | 60. syn:Synterval    | 103. bas:Reso TB mono |
| 18. sfx:Moby's Trip  | 61. syn:ObieLand     | 104. bas:A.D. 3033    |
| 19. raw:Rave Organ   | 62. syn:SWELL        | 105. bas:Tugboat      |
| 20. syn:70-64        | 63. syn:Air Age      | 106. bas:Interference |
| 21. syn:Synthex 80's | 64. syn:SMAK         | 107. bas:TaurusT mono |
| 22. syn:Super Saw    | 65. syn:Tink         | 108. bas:DistTB1 mono |
| 23. syn:XtoZ         | 66. syn:FizzeeString | 109. bas:Bullit mono  |
| 24. syn:Spiders mono | 67. bas:P-dg mono    | 110. bas:Mo'          |
| 25. syn:Brass Juice  | 68. bas:Ring Bassox  | 111. bas:HybridPhased |
| 26. syn:Raved Pass   | 69. bas:Saws Normal  | 112. bas:UKshoot mono |
| 27. syn:South Euro 1 | 70. bas:T-Dance mono | 113. hit:Dinkness     |
| 28. syn:South Euro 2 | 71. bas:Bongo-B      | 114. hit:PolyClavWorm |
| 29. syn:Digitell     | 72. bas:Top Tri mono | 115. hit:Organist     |
| 30. syn:Quadralike   | 73. bas:Hard X       | 116. hit:Orgy Hitts   |
| 31. syn:BigDandyBoy  | 74. bas:Hupper mono  | 117. hit:DeepStall    |
| 32. syn:Riverdancing | 75. bas:POLY         | 118. hit:More Cheez   |
| 33. syn:Rendalaw     | 76. bas:2000 mono    | 119. hit:PLATINUM     |
| 34. syn:Dappy        | 77. bas:F16 mono     | 120. hit:Guit Hits    |
| 35. syn:Saw On High  | 78. bas:Bounce       | 121. hit:EP Rolls     |
| 36. syn:Tink Or Toys | 79. bas:FATSO mono   | 122. hit:Enrezzle     |
| 37. syn:C Z O        | 80. bas:H20 mono     | 123. hit:Lowy Techno  |
| 38. syn:OBX          | 81. bas:SuB DuH mono | 124. hit:Dreamer Tags |
| 39. syn:SinEnsemble  | 82. bas:RingCycle    | 125. hit:FoonZoom     |
| 40. syn:CZ BIG       | 83. bas:Ripin mono   | 126. hit:Ghost Organ  |
| 41. syn:Wide Load    | 84. bas:REZvsSINE    | 127. hit:Brazzy Hits  |
| 42. syn:Cvox         | 85. bas:Love Bee     |                       |

Preset Listing

User Bank 1, XLEAD Bank 1

- |                      |                      |                       |
|----------------------|----------------------|-----------------------|
| 0. raw:Classic Tri   | 43. pad:Daddy's Girl | 86. edg:Low Edge      |
| 1. raw:Sync4Sequece  | 44. pad:Ice Dreams   | 87. edg:Love II mono  |
| 2. raw:Prophety      | 45. pad:SaturnRings  | 88. edg:Bare Edge     |
| 3. raw:Ringer mono   | 46. pad:Smoovie      | 89. edg:Honker        |
| 4. raw:Play Sawcomp  | 47. pad:Aki's World  | 90. edg:Mr.Edge       |
| 5. raw:Drama         | 48. pad:Low Back     | 91. edg:19inch Nails  |
| 6. raw:Big Synth     | 49. pad:Warm&Lush    | 92. vox:Zephyr        |
| 7. raw:Syn Brass     | 50. pad:Lonely Space | 93. vox:Air Voices    |
| 8. raw:MortalSynth   | 51. pad:Pure Synth   | 94. vox:SIRRUS        |
| 9. raw:Farzy Sync    | 52. pad:HarmonicLift | 95. vox:Future Vox    |
| 10. raw:SLICER       | 53. pad:Sawpipe      | 96. vox:Bliss         |
| 11. raw:Rez Zip mono | 54. pad:www.f mono   | 97. vox:ARMAGEDDON    |
| 12. raw:3 O 3 mono   | 55. pad:Spelunkers   | 98. vox:ANGELIKA      |
| 13. raw:Acid Blomp   | 56. pad:aRt DeKo     | 99. vox:Galaxal       |
| 14. raw:Booty Qooty  | 57. pad:Shaku High   | 100. vox:Bandvoxxe    |
| 15. raw:Ubo mono     | 58. pad:Symphonix    | 101. vox:Exploration  |
| 16. raw:Euro Noise   | 59. pad:Softaflange  | 102. vox:AfterShock   |
| 17. raw:SweeTDreaM   | 60. pad:Lifedream    | 103. vox:SURFaCinG    |
| 18. raw:Edge         | 61. edg:Spawn mono   | 104. vox:Ethereal     |
| 19. raw:Mini 2000    | 62. edg:HlywdINative | 105. vox:Suffocating  |
| 20. raw:Basic Dodo   | 63. edg:PUNISH mono  | 106. vox:Space Voxxal |
| 21. raw:Basic Buzz   | 64. edg:Prephad      | 107. vox:Upper Bottom |
| 22. raw:Basic 2600   | 65. edg:SCRAPE mono  | 108. air:GhostStories |
| 23. raw:Low SawSweep | 66. edg:REZANATOR    | 109. air:Breath Stack |
| 24. raw:Low CL2Sweep | 67. edg:ACiDOP mono  | 110. air:Tibet        |
| 25. raw:BLAHSOM      | 68. edg:Ringer mono  | 111. air:Futura       |
| 26. raw:Flaps        | 69. edg:FuzzGrinder  | 112. air:Air Surf :-) |
| 27. raw:TeeTH        | 70. edg:BAD A mono   | 113. air:Eastern Mist |
| 28. raw:Prophet      | 71. edg:B-CUDA mono  | 114. air:Vampirella   |
| 29. raw:Profit Braz  | 72. edg:Swervy       | 115. air:Sonar Ghost  |
| 30. pad:BP Strings   | 73. edg:Love All     | 116. air:Druidz Song  |
| 31. pad:Slow Dance   | 74. edg:Space Komper | 117. air:Digital Noiz |
| 32. pad:Astrology    | 75. edg:SynkerSteppr | 118. air:Scary Noise  |
| 33. pad:DARK CITY    | 76. edg:SQUEAKE mono | 119. air:StickyFinger |
| 34. pad:Enoze Tri    | 77. edg:Syncked      | 120. air:LeaveMeAlone |
| 35. pad:Hi&LowLights | 78. edg:2Flange mono | 121. air:Breathless   |
| 36. pad:Danube       | 79. edg:Listoller    | 122. air:FluteState   |
| 37. pad:Vespers      | 80. edg:Reptoa       | 123. led:More Senses  |
| 38. pad:Jumpy Brass  | 81. edg:TotalControl | 124. led:Hisynk Lead  |
| 39. pad:Rio Dulce    | 82. edg:Growly Glide | 125. led:P5 Zentropa  |
| 40. pad:Big Aud'Pad  | 83. edg:Small Town   | 126. led:Funky-B mono |
| 41. pad:Gorgontastic | 84. edg:Zorkon       | 127. led:Solo Environ |
| 42. pad:SlogritStrng | 85. edg:Skreecher    |                       |

Preset Listing

User Bank 2, XLEAD Bank 2

0. bpm:Synthex 80's	43. arp:Dreamer	86. wal:REZARECT
1. bpm:Tempo LFOs	44. arp:Palomar	87. wal:Tension
2. bpm:Cult-feel	45. arp:theGrind	88. wal:Arrival
3. bpm:SakuraTime	46. arp:Fundamentals	89. wal:Maryland
4. bpm:"Carpe Diem"	47. arp:Tron X	90. wal:ByzantineNze
5. bpm:Monster	48. arp:XL Feel	91. wal:Thickets
6. bpm:Love 1	49. arp:B-loid	92. wal:Big Wall
7. bpm:Bouncerette	50. arp:Glider	93. wal:Silkness
8. bpm:L'room mono	51. arp:Axis One	94. wal:Marvs Modulo
9. bpm:Reepeter	52. arp:Bouchete	95. wal:Luscious
10. bpm:HOUSE	53. arp:Saw Standard	96. wal:BACKDRAFT
11. bpm:GRITS	54. arp:Tekno Cheep	97. wal:I made it
12. bpm:TRIPPER	55. arp:Phrophetics	98. wal:DailyBread
13. bpm:Higher Power	56. arp:SineDrum	99. wal:Clavonate
14. bpm:Solace	57. arp:CricketGruve	100. wal:HoverCraft
15. bpm:Lunar Pad	58. arp:Whisper	101. wal:C-Ride mono
16. bpm:CReeP mono	59. arp:Gut-P mono	102. wal:Duckfuzz
17. bpm:Trashy	60. arp:MooGie-D	103. wal:MaMMoTH mono
18. bpm:Mercy	61. arp:No Lo	104. wal:Ice Ring
19. bpm:Wading	62. arp:Trip Hard	105. wal:Love 2bee
20. bpm:Multisteps	63. arp:Sanctuary	106. wal:Uncle Fester
21. bpm:Squeapels	64. arp:LITTLE Guy	107. wal:THE MACHEEN
22. bpm:Grinded	65. arp:Kosy Love	108. wal:Strangled
23. bpm:SteppedDream	66. arp:Bust In	109. wal:DOOM 2020
24. bpm:Clocking Out	67. arp:Uroboros	110. led:JungleX mono
25. bpm:Bubbler	68. arp:Mighty Pulse	111. led:Hypass Ditty
26. bpm:End	69. arp:JUNOsis	112. led:Mono PolyFX
27. bpm:Wicked Low	70. arp:C2-Play me	113. led:Muffle Sync
28. bpm:RadioDaze	71. arp:C2-Play me2	114. led:CazioTone
29. bpm:Panhandel	72. arp:T-2000	115. led:Groove Wow
30. bpm:Sparkle	73. arp:HardNormlMom	116. led:Technoval
31. bpm:Square Rise	74. arp:On The Run	117. led:Krane mono
32. arp:Holographik	75. arp:Pissto Hi	118. led:Wormsine
33. arp:Pele	76. arp:Byg Stryngs	119. led:Dreamlead
34. arp:C2 Dmachine	77. arp:Space Coast	120. led:Tunnelituar
35. arp:Lust up mono	78. arp:Futura	121. led:Crunchette
36. arp:Bottom Perc	79. wal:Ripped	122. led:Blizzer
37. arp:You Know It	80. wal:Balls2The...	123. led:Junosquare
38. arp:Toxic Vox	81. wal:W6 3sEvEn	124. led:Multisync
39. arp:Deeper Love	82. wal:Field	125. led:WiggleWorm
40. arp:Full Time	83. wal:ABYSS	126. led:Levita Brass
41. arp:OrbisTabula1	84. wal:DonkeyBreath	127. led:DesertTrance
42. arp:OrbisPitcher	85. wal:GoSpeedRacer	

Preset Listing

User Bank 3, XLEAD Bank 3

- |                      |                      |                       |
|----------------------|----------------------|-----------------------|
| 0. bts:D&B Tight     | 43. bts:HI-NRG       | 86. nse:Uncowardinar  |
| 1. bts:D&B Smooth    | 44. bts:Trance Date  | 87. nse:Hadrian's     |
| 2. bts:LoFi          | 45. bts:Club it      | 88. nse:Quiet Wall    |
| 3. bts:Indy-T        | 46. bts:Groove II    | 89. nse:Machined      |
| 4. bts:Rocket        | 47. bts:Groove IT    | 90. nse:Cast          |
| 5. bts:Elbow>>Room   | 48. bts:C-Man        | 91. nse:MaRTIaNS      |
| 6. bts:L-101         | 49. bts:Humana       | 92. nse:Soline 9x     |
| 7. bts:Rush          | 50. kit:80's Tones   | 93. nse:PARANO mono   |
| 8. bts:Lo-Z          | 51. kit:K'werk It    | 94. nse:Masses        |
| 9. bts:Acid-dia      | 52. kit:BoomBoxx     | 95. nse:Saturn mono   |
| 10. bts:K-work       | 53. kit:Compressed   | 96. nse:LittleWeasel  |
| 11. bts:Logic        | 54. kit:Dirty Kit    | 97. nse:Future Harmi  |
| 12. bts:Roller Girl  | 55. kit:G Club       | 98. nse:FutureSteps   |
| 13. bts:Black House  | 56. kit:MANTIS       | 99. nse:Bottom Floor  |
| 14. bts:HiHo         | 57. prc:Crash Head   | 100. nse:That'sCreepy |
| 15. bts:Ginger       | 58. prc:Kicks 1      | 101. nse:Radon Shield |
| 16. bts:Unhooked     | 59. prc:Snare 1      | 102. nse:Diffuser     |
| 17. bts:Dr&Bass DoFi | 60. prc:Construction | 103. nse:Interfear    |
| 18. bts:Dist Treo    | 61. prc:Scratchin    | 104. sfx:Odd Quasar   |
| 19. bts:Big Body     | 62. prc:Scratchin 2  | 105. sfx:S-METAL mono |
| 20. bts:Xie-racy     | 63. prc:Mixed Bag    | 106. sfx:Zoned        |
| 21. bts:4AM`/_Flyin' | 64. prc:Cooleo       | 107. sfx:OverTheEdge  |
| 22. bts:Lily's Rage  | 65. bel:Modular Ring | 108. sfx:Granules     |
| 23. bts:HBtoo        | 66. bel:Efemm Bellsa | 109. sfx:Glassers     |
| 24. bts:Light-R      | 67. bel:Mult-A-Metal | 110. sfx:Alienator    |
| 25. bts:X-Mox        | 68. bel:Mystery Bell | 111. sfx:Ripped Lazer |
| 26. bts:Dark Hero    | 69. bel:NordicCalm   | 112. sfx:FoldingSpace |
| 27. bts:007          | 70. bel:Rainbellz    | 113. sfx:Uncertainty  |
| 28. bts:The Beast    | 71. bel:Agualla Bell | 114. sfx:CosmicCompny |
| 29. bts:Europia      | 72. bel:Encapsulate  | 115. sfx:REZA'S LaB   |
| 30. bts:TranzAmbient | 73. nse:REZAWRECKT   | 116. sfx:TerrorZoNE   |
| 31. bts:Frantikk     | 74. nse:UNDERTAKER   | 117. sfx:LupeDeKool   |
| 32. bts:Tekno Tribe  | 75. nse:Coyote       | 118. sfx:CyberScience |
| 33. bts:Mind Game    | 76. nse:Turbonic     | 119. key:P-soul       |
| 34. bts:D-Houce      | 77. nse:Heavy Mental | 120. key:DeepOrg      |
| 35. bts:Heaven       | 78. nse:GrainyPixel  | 121. key:Smarm Organ  |
| 36. bts:Peak-777     | 79. nse:Faucet Drip  | 122. key:HoreGaine    |
| 37. bts:Big Shaker   | 80. nse:DarkForest   | 123. key:DxJx Organ   |
| 38. bts:808 street   | 81. nse:PsychicSea   | 124. key:SynhissOrgan |
| 39. bts:Jump Hard    | 82. nse:AarnoLdt     | 125. key:Disca Queen  |
| 40. bts:System X     | 83. nse:PLAZMA mono  | 126. key:Organik      |
| 41. bts:Semi-Time    | 84. nse:LuciferDom   | 127. :XL-1 default    |
| 42. bts:Drumatic     | 85. nse:SpottedWhite |                       |



## Riff Listing

- |                      |                          |                         |
|----------------------|--------------------------|-------------------------|
| 0. KEY-C3.mid        | 44. BTS-Dark Hero 1      | 88. HIT-Enrezzele       |
| 1. AIR-Bat Pann      | 45. BTS-Dist Treo 1      | 89. HIT-Guit Hits       |
| 2. AIR-Breathless    | 46. BTS-DoFi 1           | 90. HIT-Orgy Hitts      |
| 3. AIR-Futura        | 47. BTS-Drumatic 1.mid   | 91. HIT-Tite            |
| 4. BAS-1 Shot        | 48. BTS-Elbowroom 1      | 92. KEY-C Triad.mid     |
| 5. BAS-2600x         | 49. BTS-Europiavis1      | 93. KEY-C2 (2 Bars)     |
| 6. BAS-3O3x          | 50. BTS-Frantikk 1.mid   | 94. KEY-C2 (4 Bars)     |
| 7. BAS-Acid Mono     | 51. BTS-Ginger 1         | 95. KEY-C3 (2 Bars).mid |
| 8. BAS-BadTubex      | 52. BTS-Groove II 1      | 96. KEY-C3 (4 Bars).mid |
| 9. BAS-Bullit        | 53. BTS-Groove IT 1      | 97. KEY-C4.mid          |
| 10. BAS-Dist TB1     | 54. BTS-HBtoo 3          | 98. KEY-Cm7.mid         |
| 11. BAS-DistortoTBx  | 55. BTS-Heaven 3         | 99. KEY-Cm9.mid         |
| 12. BAS-DoFi         | 56. BTS-HiHo 1           | 100. KEY-Cmaj7.mid      |
| 13. BAS-Filter 1     | 57. BTS-Indy-T 1         | 101. KEY-CUp-Down.mid   |
| 14. BAS-Filter 2     | 58. BTS-Jump Hard 1      | 102. KEY-Cs Up.mid      |
| 15. BAS-Filter 3     | 59. BTS-Kraftwork 1      | 103. KEY-DxJx           |
| 16. BAS-Heavy M      | 60. BTS-L-101 1          | 104. KEY-Groove         |
| 17. BAS-Interfear    | 61. BTS-Light-R 1.smf    | 105. KEY-Organik        |
| 18. BAS-Lo-Za        | 62. BTS-Lo-Z 1           | 106. KEY-Synhiss        |
| 19. BAS-Metal Heartx | 63. BTS-LoFi 1           | 107. KIT-80's 4track    |
| 20. BAS-Mini Morex   | 64. BTS-Logic1           | 108. KIT-Boom 4track    |
| 21. BAS-Pdg          | 65. BTS-Mind Game 2      | 109. KIT-Compre 4track  |
| 22. BAS-Q Bassx      | 66. BTS-Mind Game 3      | 110. KIT-Dirt 5track    |
| 23. BAS-SE Microx    | 67. BTS-Peak777 1        | 111. KIT-G 4track       |
| 24. BAS-Say Whatx    | 68. BTS-Perception 1     | 112. KIT-Hide 4track    |
| 25. BAS-Shiftx       | 69. BTS-RollerGirl 1.mid | 113. KIT-K'werk 4track  |
| 26. BAS-Sub Corex    | 70. BTS-Rush 1           | 114. KIT-Mant 4track    |
| 27. BEL-Bellsa       | 71. BTS-Semi-Time 2      | 115. LED-Boxt mono      |
| 28. BEL-Modular      | 72. BTS-System X 1       | 116. LED-Krane          |
| 29. BEL-Mystery      | 73. BTS-TeknoTribe 1     | 117. LED-More S         |
| 30. BPM-Boogy        | 74. BTS-The Beast 1.mid  | 118. LED-Tunnel         |
| 31. BPM-Bounce       | 75. BTS-Trancer 1        | 119. LED-Wet            |
| 32. BPM-UnderC       | 76. BTS-TranzAmbient     | 120. NSE-LucyF          |
| 33. BTS-007 1        | 77. BTS-Unhooked 1       | 121. PAD-BP Strings     |
| 34. BTS-4am flyin 1  | 78. BTS-X-Mox 1.smf      | 122. PAD-Danube         |
| 35. BTS-808 Street 1 | 79. BTS-Xie-racy 1       | 123. PAD-Dark City      |
| 36. BTS-Acid 1       | 80. BTS-HI-NRG           | 124. PRC-Construct      |
| 37. BTS-Big Body 1   | 81. BTS-Trance Date 1    | 125. PRC-Crash Head     |
| 38. BTS-Big Shaker 1 | 82. BTS-Club it 1        | 126. RAW-Drama          |
| 39. BTS-BlackHouse1  | 83. BTS-Lily's Rage      | 127. SYN- 7064          |
| 40. BTS-D&B Smooth 2 | 84. BTS-Rocket           | 128. SYN-4 track a      |
| 41. BTS-D&B Tight 1  | 85. EDG-Boxt filter      | 129. SYN-4 track b      |
| 42. BTS-D-House 1    | 86. EDG-FilterQ          | 130. SYN-Basic          |
| 43. BTS-DJ-A.mid     | 87. GTR-Chuckinx         | 131. SYN-Compu X        |

*Riff Listing*

- 132. SYN-Enviroment
- 133. SYN-Grind Me
- 134. SYN-Nordica
- 135. SYN-Octivate
- 136. SYN-Orion
- 137. SYN-Quadra
- 138. SYN-Saint
- 139. SYN-Sinner
- 140. SYN-South E2
- 141. SYN-Tran 3track
- 142. SYN-Tripper
- 143. VOX-Bliss
- 144. VOX-Zephr
- 145. WAL-Abyss
- 146. WAL-CRide
- 147. WAL-Love 2bee
- 148. WAL-Mammoth
- 149. WAL-Raverot
- 150. XTR-Booty Q
- 151. BTS-C-Man
- 152. BTS-Humana

## Instrument Listing

This section lists the raw instruments in the XL-1 ROM set. Instruments consist of either multisamples or single samples.

- |                    |                     |                     |
|--------------------|---------------------|---------------------|
| 0. None            | 41. Audity Synth 2  | 82. Zeek Bass       |
| 1. Sine Wave       | 42. Audity Synth 3  | 83. Audity Bell 1   |
| 2. Saw Wave        | 43. Audity Synth 4  | 84. Audity Bell 2   |
| 3. Square Wave     | 44. Audity Synth 5  | 85. Audity Bell 3   |
| 4. Triangle Wave   | 45. Audity Synth 6  | 86. Audity Bell 4   |
| 5. Audity Saw      | 46. Audity Synth 7  | 87. Audity Bell 5   |
| 6. Audity Square   | 47. Audity Synth 8  | 88. Vox Humana      |
| 7. Audity Blend    | 48. Audity Synth 9  | 89. Vapor Vox       |
| 8. Audity Sync     | 49. Audity Synth 10 | 90. Chronic Vox     |
| 9. Audity Sync     | 50. Audity Synth 11 | 91. Vox Wave 1      |
| 10. Audity Sync 1  | 51. Audity Synth 12 | 92. Vox Wave 2      |
| 11. Audity Sync 2  | 52. Audity Synth 13 | 93. Vox Wave 3      |
| 12. Audity Sync 3  | 53. Audity Synth 14 | 94. Vox Wave 4      |
| 13. Audity PWM 1   | 54. Audity Bass 1   | 95. Vox Wave 5      |
| 14. Audity PWM 2   | 55. Audity Bass 2   | 96. Vox Wave 6      |
| 15. Audity PWM 3   | 56. Audity Bass 3   | 97. White Noise     |
| 16. Ring Mod 1     | 57. Acid Bass 1     | 98. Pink Noise      |
| 17. Ring Mod 2     | 58. Acid Bass 2     | 99. Audity Wall 1   |
| 18. Ring Mod 3     | 59. Acid Bass 3     | 100. Audity Wall 2  |
| 19. Metal Wave     | 60. Acid Bass 4     | 101. Audity Wall 3  |
| 20. Jungle Lead    | 61. Acid Bass 5     | 102. Audity Wall 4  |
| 21. Metalik        | 62. Acid Bass 6     | 103. Audity Wall 5  |
| 22. Brass Lead 1   | 63. Acid Bass 7     | 104. Audity Wall 6  |
| 23. Brass Lead 2   | 64. Acid Bass 8     | 105. Audity Wall 7  |
| 24. Audity Lead 1  | 65. Acid Bass 9     | 106. Noise Tunnel   |
| 25. Audity Lead 2  | 66. Acid Bass 10    | 107. Air Pipe       |
| 26. Audity Lead 3  | 67. Hybrid Bass 1   | 108. Crystal Cavern |
| 27. Audity Lead 4  | 68. Hybrid Bass 2   | 109. Sonar          |
| 28. Audity Lead 5  | 69. Hybrid Bass 2b  | 110. Audity Edge 1  |
| 29. Audity Lead 6  | 70. Dance Bass 1    | 111. Audity Edge 1b |
| 30. Audity Lead 7  | 71. Dance Bass 2    | 112. Audity Edge 1c |
| 31. Audity Lead 8  | 72. Mikro Bass      | 113. Audity Edge 2  |
| 32. Audity Lead 9  | 73. Shush Bass      | 114. Audity Edge 3  |
| 33. Audity Lead 10 | 74. Fuzz Bass       | 115. Future World   |
| 34. Audity Lead 11 | 75. Flange Bass     | 116. Grinder        |
| 35. Classic Lead 1 | 76. Buzz Bass       | 117. Growly         |
| 36. Classic Lead 2 | 77. Booty Q Bass 1  | 118. Cricket        |
| 37. Classic Lead 3 | 78. Booty Q Bass 2  | 119. Fuzz Ball      |
| 38. Classic Lead 4 | 79. Zodiac Bass 1   | 120. Droid Scrape   |
| 39. Digi Lead      | 80. Zodiac Bass 2   | 121. Rez Honk       |
| 40. Audity Synth 1 | 81. Produgal Bass   | 122. Krunchy Hit    |

*Instrument Listing*

123.	Turbo	168.	Looped Perc 29	213.	1 Shot Perc 22
124.	Interference	169.	Looped Perc 30	214.	1 Shot Perc 23
125.	1 Shot Bass	170.	Looped Perc 31	215.	1 Shot Perc 24
126.	1 Shot Dis Bass 1	171.	Looped Perc 32	216.	1 Shot Perc 25
127.	1 Shot Dis Bass 2	172.	Looped Perc 33	217.	1 Shot Perc 26
128.	1 Shot Dis Bass 3	173.	Looped Perc 34	218.	1 Shot Perc 27
129.	1 Shot Perc Bass	174.	Looped Perc 35	219.	1 Shot Perc 28
130.	1 Shot Grind	175.	Looped Perc 36	220.	1 Shot Perc 29
131.	1 Shot Siren	176.	Looped Perc 37	221.	1 Shot Perc 30
132.	1 Shot Turbine	177.	Looped Perc 38	222.	1 Shot Perc 31
133.	1 Shot Alien	178.	Looped Perc 39	223.	1 Shot Perc 32
134.	1 Shot Laser Rip	179.	Looped Perc 40	224.	1 Shot Perc 33
135.	1 Shot Aud Vox	180.	Looped Perc 41	225.	1 Shot Perc 34
136.	1 Shot Scratch 1	181.	Looped Perc 42	226.	1 Shot Perc 35
137.	1 Shot Scratch 2	182.	Looped Perc 43	227.	1 Shot Perc 36
138.	1 Shot Scratch 3	183.	Looped Perc 44	228.	1 Shot Perc 37
139.	1 Shot Scratch 4	184.	Looped Perc 45	229.	1 Shot Perc 38
140.	Looped Perc 1	185.	Looped Perc 46	230.	1 Shot Perc 39
141.	Looped Perc 2	186.	Looped Perc 47	231.	1 Shot Perc 40
142.	Looped Perc 3	187.	Looped Perc 48	232.	1 Shot Perc 41
143.	Looped Perc 4	188.	Looped Perc 49	233.	1 Shot Perc 42
144.	Looped Perc 5	189.	Looped Perc 50	234.	1 Shot Perc 43
145.	Looped Perc 6	190.	Looped Perc 51	235.	1 Shot Perc 44
146.	Looped Perc 7	191.	Looped Perc 52	236.	1 Shot Perc 45
147.	Looped Perc 8	192.	1 Shot Perc 1	237.	1 Shot Perc 46
148.	Looped Perc 9	193.	1 Shot Perc 2	238.	1 Shot Perc 47
149.	Looped Perc 10	194.	1 Shot Perc 3	239.	1 Shot Perc 48
150.	Looped Perc 11	195.	1 Shot Perc 4	240.	1 Shot Perc 49
151.	Looped Perc 12	196.	1 Shot Perc 5	241.	1 Shot Perc 50
152.	Looped Perc 13	197.	1 Shot Perc 6	242.	1 Shot Perc 51
153.	Looped Perc 14	198.	1 Shot Perc 7	243.	1 Shot Perc 52
154.	Looped Perc 15	199.	1 Shot Perc 8	244.	1 Shot Perc 53
155.	Looped Perc 16	200.	1 Shot Perc 9	245.	1 Shot Perc 54
156.	Looped Perc 17	201.	1 Shot Perc 10	246.	1 Shot Perc 55
157.	Looped Perc 18	202.	1 Shot Perc 11	247.	1 Shot Perc 56
158.	Looped Perc 19	203.	1 Shot Perc 12	248.	1 Shot Perc 57
159.	Looped Perc 20	204.	1 Shot Perc 13	249.	1 Shot Perc 58
160.	Looped Perc 21	205.	1 Shot Perc 14	250.	1 Shot Perc 59
161.	Looped Perc 22	206.	1 Shot Perc 15	251.	1 Shot Perc 60
162.	Looped Perc 23	207.	1 Shot Perc 16	252.	1 Shot Perc 61
163.	Looped Perc 24	208.	1 Shot Perc 17	253.	1 Shot Perc 62
164.	Looped Perc 25	209.	1 Shot Perc 18	254.	1 Shot Perc 63
165.	Looped Perc 26	210.	1 Shot Perc 19	255.	1 Shot Perc 64
166.	Looped Perc 27	211.	1 Shot Perc 20	256.	1 Shot Perc 65
167.	Looped Perc 28	212.	1 Shot Perc 21	257.	1 Shot Perc 66

*Instrument Listing*

258.	1 Shot Perc 67	303.	Analow	348.	Perco
259.	1 Shot Perc 68	304.	Moog Tri	349.	Not So Mini
260.	1 Shot Perc 69	305.	Moog Sub	350.	Spitt
261.	1 Shot Perc 70	306.	Moogy	351.	Tap
262.	1 Shot Perc 71	307.	Fat Sun	352.	Juno Sub
263.	1 Shot Perc 72	308.	Analog	353.	Complex Sub
264.	1 Shot Perc 73	309.	Q 1	354.	Full Octave
265.	1 Shot Perc 74	310.	Q 2	355.	Deep Pocket
266.	1 Shot Perc 75	311.	Q 3	356.	JP4
267.	1 Shot Perc 76	312.	Planet	357.	Synth Hits
268.	1 Shot Perc 77	313.	2600	358.	DX 1
269.	1 Shot Perc 78	314.	Synth 1	359.	DX 2
270.	1 Shot Perc 79	315.	Synth 2	360.	DX 3
271.	1 Shot Perc 80	316.	Synth 3	361.	EP 1
272.	1 Shot Perc 81	317.	Synth 4	362.	EP 2
273.	Audity Scratches	318.	Synth 5	363.	EP 3
274.	El Perc Kit 1	319.	Synth 6	364.	Home 1
275.	El Kit 1 Looped	320.	Synth 7	365.	Home 2
276.	Kit 1 Env Loops	321.	Synth 8	366.	Street
277.	El Perc Kit 2	322.	Synth 9	367.	Pure
278.	El Kit 2 Looped	323.	Synth 10	368.	Fing&Harms 1
279.	Kit 2 Env Loops	324.	TB 1	369.	Fing&Harms 2
280.	Hybrid Perc	325.	TB 2	370.	All Purpose
281.	Warehouse Perc	326.	TB 3	371.	Standard
282.	Acoustic Perc A	327.	TB 4	372.	Fretless 1
283.	Ac Kick+Snare B	328.	CZ101	373.	Fretless 2
284.	Acoustic Kit A+B	329.	PPG	374.	Fretless 3
285.	Hardcore Kit 1	330.	Mini 1	375.	Fretless 4
286.	Hardcore Kit 2	331.	Mini 2	376.	Upright 1
287.	Hardcore Kit 3	332.	Mini 3	377.	Upright 2
288.	Hum	333.	Mini 4	378.	Slap 1
289.	Below Sub	334.	Saw	379.	Slap 2
290.	Super Sub	335.	Ultimate 1	380.	Gruzzly Pop
291.	SE Sub 1	336.	Ultimate 2	381.	Pop Slide 1
292.	SE Sub 2	337.	Micro Moog	382.	Pop Slide 2
293.	SE Sub 3	338.	DB9 1	383.	Pop Slide 3
294.	SE Sub 4	339.	DB9 2	384.	Pop Slide 4
295.	SE Sub 5	340.	Phlappy	385.	Funk Hits
296.	SE Sub 6	341.	Power Q	386.	Organ 1
297.	SE Sub 7	342.	Big Sync	387.	Organ 2
298.	Hit	343.	Buzzer	388.	Mutes
299.	Subtle	344.	Saw Sync	389.	Power 1
300.	Mem Moog	345.	Pocket	390.	Power 2
301.	Lowness	346.	Q Attack Sub	391.	Power Hit
302.	Ice	347.	Sonics	392.	Synth Axe

*Instrument Listing*

393. Hits	438. Rast Keys	483. Rezy
394. Pipe Organ	439. ARP Sync	484. Hi Octaves
395. DrawbarOrgan	440. Narrow Synth	485. Dreemy
396. Perc Organ	441. Fat Attack	486. Phat
397. Org Day	442. ARP Lead	487. Tekno
398. Disco Organ	443. Synthetic	488. Life
399. DX Organ	444. Overtone	489. Classic
400. JX Organ	445. Buzz Saw	490. Dreamer
401. Tone Organ	446. Blipper	491. Paddy
402. Simple Organ	447. Full Synth	492. Dance Chord
403. Org Lite	448. Bass Synth	493. Zoom
404. Org Nod	449. Mini Lead	494. Keyngdom
405. Full Organ	450. Sawtooth	495. Oddd Organ
406. Synth Organ	451. M12 Lead	496. Mood Strings
407. BreathyOrgan	452. Sync Wave 1	497. Brazz
408. Dance Organ	453. Sync Wave 2	498. Synthy
409. Farfisa 1	454. Sync Wave 3	499. P5
410. Farfisa 2	455. Sync Wave 4	500. Bari Wave
411. Vox Organ	456. Sync Wave 5	501. Sax Wave
412. Synth Cheeze	457. Sync Wave 6	502. Mute Trumpet
413. Organ Hits 1	458. Pop Square	503. Trumpet FX 1
414. Organ Hits 2	459. Juno Square	504. Trumpet FX 2
415. Tine EP	460. SquareAttack	505. Cool Loops
416. Pretty EP	461. Square Lead	506. Sax Riff
417. Classic EP	462. SquareChorus	507. Boink
418. FM EP 1	463. Sinusoid	508. Classic Hit
419. FM EP 2	464. Worm Lead 1	509. Hits 1
420. EP Hits	465. Worm Lead 2	510. Hits 2
421. Clavinet	466. Worm Lead 3	511. Jax Breath
422. Piano Wave	467. Worm Lead 4	512. Synth
423. Xylo Pad	468. Worm Lead 5	513. Orch
424. Pure H20	469. Worm Lead 6	514. Soul Oohs
425. Log Hit	470. Harmonica	515. CMI Breath
426. Pluck Tone	471. Synth Flute	516. Breathy
427. Hollow Deep	472. Soft Synth	517. Tarzana
428. Bell Synth	473. Hi String	518. Gothic
429. Syn Tone	474. OBX Saws	519. Oow
430. Perc Axe	475. Big Planet	520. Vox 1
431. Whine	476. JP6 Pad	521. Vox 2
432. CZ101 Digi	477. Saw Sweep	522. Strings
433. CZ Lead	478. Juno Pulse	523. All Dance 1
434. CZ Echo Lead	479. CZ Synstring	524. All Dance 2
435. Wild Synth	480. Ensemble	525. Sound Track
436. Spacey Keys	481. Rezy Wave	526. Music Crowd
437. Digi Buzz	482. Heavy	527. Lawn Mower

*Instrument Listing*

528.	Riff Trip	572.	Cowbell	616.	Dance 24
529.	Cyber Pan	573.	Agogos	617.	Dance 25
530.	Groove Thing	574.	Misc 1	618.	Dance 26
531.	Science	575.	Misc 2	619.	Dance 27
532.	Under Pad FM	576.	kit:1	620.	Organ 1
533.	Sci Fi	577.	kit:2	621.	Organ 2
534.	Synth Siren	578.	kit:3	622.	Organ 3
535.	Metal	579.	kit:4	623.	Organ 4
536.	Vinyl 1	580.	kit:5	624.	Organ 5
537.	Vinyl 2	581.	kit:6	625.	Organ 6
538.	Vinyl 3	582.	kit:7	626.	UnisonString
539.	Vinyl 4	583.	kit:8	627.	Unison Brass
540.	Pink	584.	kit:9	628.	Brass 1
541.	White	585.	kit:10	629.	Brass 2
542.	Scratches 1	586.	kit:11	630.	Brass 3
543.	Scratches 2	587.	kit:12	631.	Brass 4
544.	Kicks 1	588.	kit:13	632.	Brass 5
545.	Kicks 2	589.	kit:14	633.	Brass 6
546.	Snares 1	590.	kit:15	634.	Brass 7
547.	Snares 2	591.	kit:16	635.	Brass 8
548.	Toms 1	592.	GM Dance	636.	Brass 9
549.	Toms 2	593.	Dance 1	637.	Brass 10
550.	Timbales 1	594.	Dance 2	638.	Brass 11
551.	Timbales 2	595.	Dance 3	639.	Brass 12
552.	Congas etc 1	596.	Dance 4	640.	Brass 13
553.	Congas etc 2	597.	Dance 5	641.	Brass 14
554.	Hats 1	598.	Dance 6	642.	Brass 15
555.	Hats 2	599.	Dance 7	643.	Brass 16
556.	Cymbals 1	600.	Dance 8	644.	Brass 17
557.	Cymbals 2	601.	Dance 9	645.	Brass 18
558.	Shakers	602.	Dance 10	646.	Brass 19
559.	Maracas	603.	Dance 11	647.	Brass 20
560.	Bells 1	604.	Dance 12	648.	Trumpet FX 1
561.	Bells 2	605.	Dance 13	649.	Trumpet FX 2
562.	Blocks 1	606.	Dance 14	650.	Trumpet FX 3
563.	Blocks 2	607.	Dance 15	651.	Trumpet FX 4
564.	Tams 1	608.	Dance 16	652.	Trumpet FX 5
565.	Tams 2	609.	Dance 17	653.	Sax FX 1
566.	Claps 1	610.	Dance 18	654.	Sax FX 2
567.	Claps 2	611.	Dance 19	655.	Sax FX 3
568.	Snaps	612.	Dance 20	656.	Blipp
569.	Clave	613.	Dance 21	657.	Buzz Blip
570.	Vibraslap	614.	Dance 22	658.	Game
571.	Guiro	615.	Dance 23	659.	Dissss

*Instrument Listing*

660. Siren Loop	705. Gtr Wawa 3	750. Wazzup?
661. Bell	706. Gtr Wawa 4	751. Barker
662. Klank	707. Gtr Wawa 5	752. Plunger
663. Metal	708. Gtr Wawa 6	753. Skipper
664. Slinky Q	709. Heavy Guitar	754. Fast
665. Space Whip	710. HeavyGtrDive	755. Kick 1
666. Short Quack	711. Drum Stab	756. Kick 2
667. Quack Ahhh	712. Guit On It	757. Kick 3
668. Bowser Bark	713. Jazz Short	758. Kick 4
669. Chiffin	714. Blamp	759. Kick 5
670. CMI Hot Air	715. Bass Slide	760. Kick 6
671. L9000 Noise	716. Hip Hop	761. Kick 7
672. Comon Vox	717. Drum Stall	762. Kick 8
673. Odd Vox	718. Stalled	763. Kick 9
674. Mmm Hmm	719. Wind Down 1	764. Kick 10
675. Ah Hah	720. Wind Down 2	765. Kick 11
676. EP Roll 1	721. Ripped	766. Kick 12
677. EP Roll 2	722. Space Wiggle	767. Kick 13
678. EP Roll 3	723. Sqweal Rev	768. Kick 14
679. EP Fog	724. Draggit	769. Kick 15
680. Fat Low Syn	725. MC	770. Kick 16
681. Bass Stab 1	726. Fun	771. Kick 17
682. Bass Stab 2	727. SSSSystem 1	772. Kick 18
683. Gtr Hi Chuck	728. SSSSystem 2	773. Kick 19
684. Gtr UpStroke	729. Here	774. Kick 20
685. Gtr Scratch1	730. On It	775. Kick 21
686. Gtr Scratch2	731. Diss	776. Kick 22
687. KleanGtrChuk	732. Bow Wow	777. Kick 23
688. Gtr Jangle	733. Diva Scratch	778. Kick 24
689. Gtr Riff 1	734. Organ Blip	779. Kick 25
690. Gtr Riff 2	735. Classic Tape	780. Kick 26
691. Gtr Riff 3	736. Out!	781. Kick 27
692. Gtr FunkyHit	737. Punch It	782. Kick 28
693. Another Gtr	738. Ork	783. Kick 29
694. Jazz Riff 1	739. Tape Stop	784. Kick 30
695. Jazz Riff 2	740. Zip	785. Kick 31
696. Jazz Riff 3	741. Tape Pull	786. Kick 32
697. GtrSlideRiff	742. Wild	787. Kick 33
698. Gtr PopSlide	743. Up	788. Kick 34
699. Guitar Pop	744. Away	789. Kick 35
700. Chord Chuck	745. Frenzy	790. Kick 36
701. Guitar Slide	746. Kick 1	791. Kick 37
702. Sad Guitar	747. Kick 2	792. Kick 38
703. Gtr Wawa 1	748. Snare	793. Kick 39
704. Gtr Wawa 2	749. Tite	794. Kick 40



*Instrument Listing*

795. Kick 41	839. Snare 28	883. Snare 72
796. Kick 42	840. Snare 29	884. Snare 73
797. Kick 43	841. Snare 30	885. Snare 74
798. Kick 44	842. Snare 31	886. Snare 75
799. Kick 45	843. Snare 32	887. Snare 76
800. Kick 46	844. Snare 33	888. Snare 77
801. Kick 47	845. Snare 34	889. Snare 78
802. Kick 48	846. Snare 35	890. Snare 79
803. Kick 49	847. Snare 36	891. Snare 80
804. Kick 50	848. Snare 37	892. Snare 81
805. Kick 51	849. Snare 38	893. Snare 82
806. Kick 52	850. Snare 39	894. Snare 83
807. Kick 53	851. Snare 40	895. Snare 84
808. Kick 54	852. Snare 41	896. Snare 85
809. Kick 55	853. Snare 42	897. Snare 86
810. Kick 56	854. Snare 43	898. Snare 87
811. Kick 57	855. Snare 44	899. Snare 88
812. Snare 1	856. Snare 45	900. Snare 89
813. Snare 2	857. Snare 46	901. Snare 90
814. Snare 3	858. Snare 47	902. Snare 91
815. Snare 4	859. Snare 48	903. Snare 92
816. Snare 5	860. Snare 49	904. Snare 93
817. Snare 6	861. Snare 50	905. Snare 94
818. Snare 7	862. Snare 51	906. Snare 95
819. Snare 8	863. Snare 52	907. Snare 96
820. Snare 9	864. Snare 53	908. Snare 97
821. Snare 10	865. Snare 54	909. Snare 98
822. Snare 11	866. Snare 55	910. Snare 99
823. Snare 12	867. Snare 56	911. Snare 100
824. Snare 13	868. Snare 57	912. Snare 101
825. Snare 14	869. Snare 58	913. Snare 102
826. Snare 15	870. Snare 59	914. Snare 103
827. Snare 16	871. Snare 60	915. Snare 104
828. Snare 17	872. Snare 61	916. Snare 105
829. Snare 18	873. Snare 62	917. Snare 106
830. Snare 19	874. Snare 63	918. Tom 1
831. Snare 20	875. Snare 64	919. Tom 2
832. Snare 21	876. Snare 65	920. Tom 3
833. Snare 22	877. Snare 66	921. Tom 4
834. Snare 23	878. Snare 67	922. Tom 5
835. Snare 24	879. Snare 68	923. Tom 6
836. Snare 25	880. Snare 69	924. Tom 7
837. Snare 26	881. Snare 70	925. Tom 8
838. Snare 27	882. Snare 71	926. Tom 9

*Instrument Listing*

927. Tom 10	971. Hat 5	1015. Hat 49
928. Tom 11	972. Hat 6	1016. Hat 50
929. Tom 12	973. Hat 7	1017. Hat 51
930. Tom 13	974. Hat 8	1018. Hat 52
931. Tom 14	975. Hat 9	1019. Hat 53
932. Tom 15	976. Hat 10	1020. Hat 54
933. Tom 16	977. Hat 11	1021. Hat 55
934. Tom 17	978. Hat 12	1022. Hat 56
935. Tom 18	979. Hat 13	1023. Hat 57
936. Tom 19	980. Hat 14	1024. Hat 58
937. Tom 20	981. Hat 15	1025. Hat 59
938. Tom 21	982. Hat 16	1026. Hat 60
939. Tom 22	983. Hat 17	1027. Hat 61
940. Tom 23	984. Hat 18	1028. Hat 62
941. Tom 24	985. Hat 19	1029. Hat 63
942. Tom 25	986. Hat 20	1030. Hat 64
943. Tom 26	987. Hat 21	1031. Hat 65
944. Timbale 1	988. Hat 22	1032. Hat 66
945. Timbale 2	989. Hat 23	1033. Hat 67
946. Timbale 3	990. Hat 24	1034. Hat 68
947. Timbale 4	991. Hat 25	1035. Hat 69
948. Timbale 5	992. Hat 26	1036. Hat 70
949. Timbale 6	993. Hat 27	1037. Hat 71
950. Conga 1	994. Hat 28	1038. Hat 72
951. Conga 2	995. Hat 29	1039. Hat 73
952. Conga 3	996. Hat 30	1040. Hat 74
953. Conga 4	997. Hat 31	1041. Hat 75
954. Conga 5	998. Hat 32	1042. Hat 76
955. Conga 6	999. Hat 33	1043. Hat 77
956. Conga 7	1000. Hat 34	1044. Hat 78
957. Conga 8	1001. Hat 35	1045. Cymbal 1
958. Conga 9	1002. Hat 36	1046. Cymbal 2
959. Conga 10	1003. Hat 37	1047. Cymbal 3
960. Bongo 1	1004. Hat 38	1048. Cymbal 4
961. Bongo 2	1005. Hat 39	1049. Cymbal 5
962. Bongo 3	1006. Hat 40	1050. Cymbal 6
963. Bongo 4	1007. Hat 41	1051. Cymbal 7
964. Bongo 5	1008. Hat 42	1052. Cymbal 8
965. Bongo 6	1009. Hat 43	1053. Cymbal 9
966. Bongo 7	1010. Hat 44	1054. Cymbal 10
967. Hat 1	1011. Hat 45	1055. Cymbal 11
968. Hat 2	1012. Hat 46	1056. Cymbal 12
969. Hat 3	1013. Hat 47	1057. Cymbal 13
970. Hat 4	1014. Hat 48	1058. Cymbal 14

*Instrument Listing*

1059.	Cymbal 15	1104.	Bell 11	1149.	Clap 5
1060.	Cymbal 16	1105.	Bell 12	1150.	Clap 6
1061.	Cymbal 17	1106.	Bell 13	1151.	Clap 7
1062.	Cymbal 18	1107.	Bell 14	1152.	Clap 8
1063.	Shaker 1	1108.	Bell 15	1153.	Clap 9
1064.	Shaker 2	1109.	Bell 16	1154.	Clap 10
1065.	Shaker 3	1110.	Bell 17	1155.	Clap 11
1066.	Shaker 4	1111.	Bell 18	1156.	Clap 12
1067.	Shaker 5	1112.	Bell 19	1157.	Clap 13
1068.	Shaker 6	1113.	Bell 20	1158.	Clap 14
1069.	Shaker 7	1114.	Bell 21	1159.	Clap 15
1070.	Shaker 8	1115.	Bell 22	1160.	Clap 16
1071.	Shaker 9	1116.	Bell 23	1161.	Clap 17
1072.	Shaker 10	1117.	Bell 24	1162.	Snap 1
1073.	Shaker 11	1118.	Bell 25	1163.	Snap 2
1074.	Shaker 12	1119.	Bell 26	1164.	Snap 3
1075.	Shaker 13	1120.	Bell 27	1165.	Snap 4
1076.	Shaker 14	1121.	Bell 28	1166.	Snap 5
1077.	Shaker 15	1122.	Bell 29	1167.	Snap 6
1078.	Shaker 16	1123.	Bell 30	1168.	Misc 1
1079.	Shaker 17	1124.	Bell 31	1169.	Misc 2
1080.	Shaker 18	1125.	Block 1	1170.	Misc 3
1081.	Shaker 19	1126.	Block 2	1171.	Misc 4
1082.	Shaker 20	1127.	Block 3	1172.	Misc 5
1083.	Shaker 21	1128.	Block 4	1173.	Misc 6
1084.	Shaker 22	1129.	Block 5	1174.	Misc 7
1085.	Shaker 23	1130.	Block 6	1175.	Misc 8
1086.	Shaker 24	1131.	Block 7	1176.	Misc 9
1087.	Shaker 25	1132.	Block 8	1177.	Misc 10
1088.	Shaker 26	1133.	Block 9	1178.	Misc 11
1089.	Shaker 27	1134.	Block 10	1179.	Misc 12
1090.	Vibraslap	1135.	Block 11	1180.	Misc 13
1091.	Flexitone	1136.	Block 12	1181.	Misc 14
1092.	Bell Tree	1137.	Tam 1	1182.	Misc 15
1093.	Slay Bells	1138.	Tam 2	1183.	Misc 16
1094.	Bell 1	1139.	Tam 3	1184.	Misc 17
1095.	Bell 2	1140.	Tam 4	1185.	Misc 18
1096.	Bell 3	1141.	Tam 5	1186.	Misc 19
1097.	Bell 4	1142.	Tam 6	1187.	Misc 20
1098.	Bell 5	1143.	Tam 7	1188.	Misc 21
1099.	Bell 6	1144.	Tam 8	1189.	Misc 22
1100.	Bell 7	1145.	Clap 1	1190.	Misc 23
1101.	Bell 8	1146.	Clap 2	1191.	Misc 24
1102.	Bell 9	1147.	Clap 3	1192.	Misc 25
1103.	Bell 10	1148.	Clap 4	1193.	Misc 26

*Instrument Listing*

- 1194. Misc 27
- 1195. Misc 28
- 1196. Misc 29
- 1197. Misc 30
- 1198. Misc 31
- 1199. Misc 32
- 1200. Misc 33
- 1201. Misc 34
- 1202. Misc 35
- 1203. Misc 36
- 1204. Misc 37
- 1205. Misc 38
- 1206. Misc 39
- 1207. Misc 40
- 1208. Misc 41
- 1209. Misc 42
- 1210. Misc 43

# Trigger Layouts

## Trigger Layout 1 Setup 59

BEATS trigger layouts are saved when you save a Multisetup. Multisetups 59-62 contain four different BEATS Trigger layouts for you to check out. You may want to design your own trigger layout and when you do, be sure to save it in one of the Multisetup locations.

Note that none of these are write-protected (like the factory multisetup). They are initialized with these layouts, but you are free to overwrite them at will.

Parts 1-8 are set to C<sup>-2</sup> (effectively off). Group 1 & 2 are latched, and Start/Stop & Clear Parts are on the same trigger, so that starting and stopping the sequencer also clears active parts.

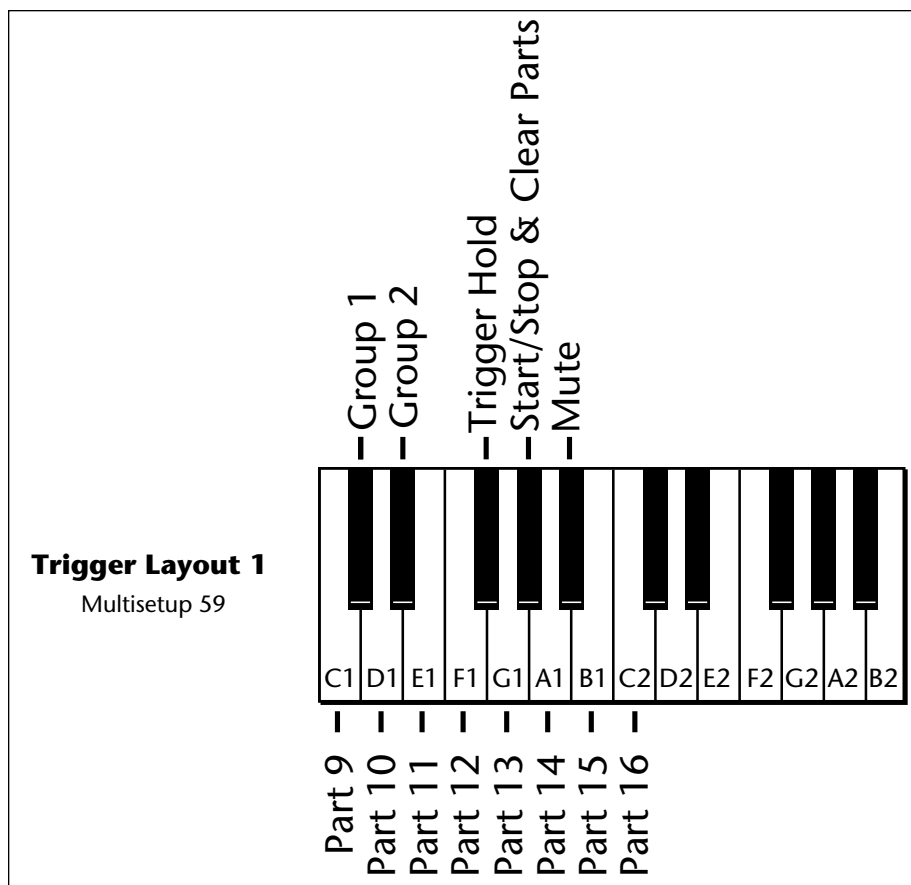

*Trigger Layout 2*  
*Setup 60*

This layout is similar to the basic layout, except that the groups and functions are on the left of the main triggers. It is setup so that it takes advantage of a 76-key keyboard by starting at E0 instead of C1. However, it can be shifted up to facilitate use on a 61-key keyboard as well.

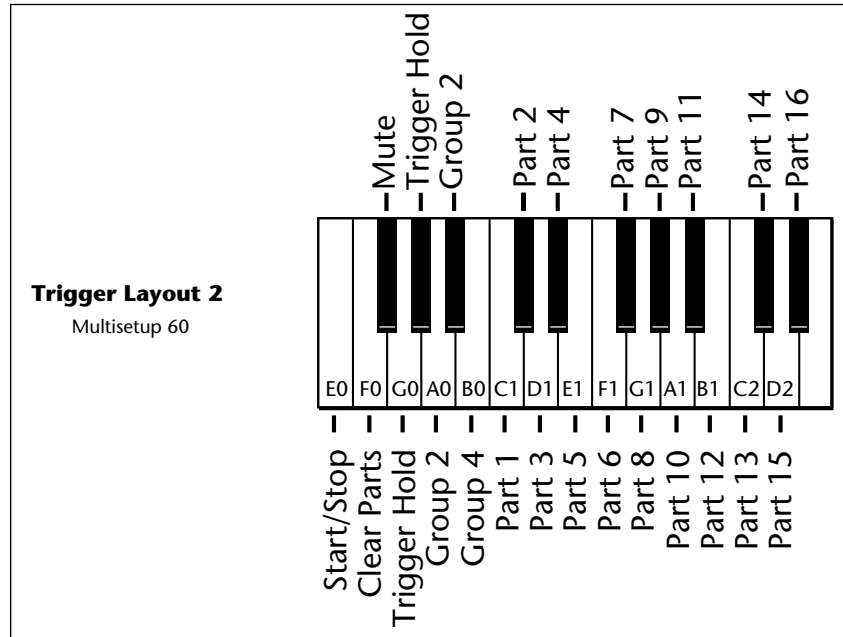

*Trigger Layout 3*  
*Setup 61*

This layout puts all of the direct part triggers consecutively on the white keys. Groups and functions are put up on the black keys.

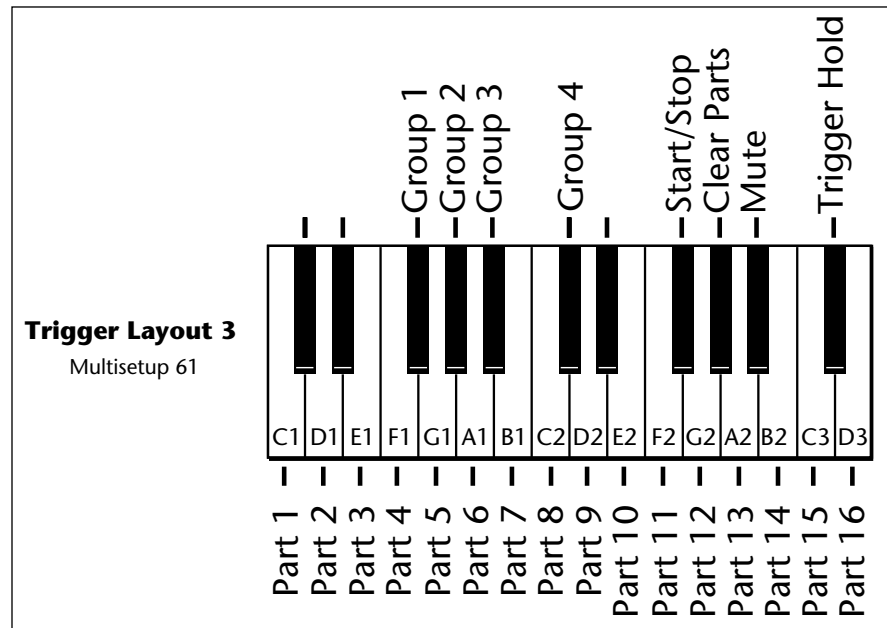

*Trigger Layout 4*  
*Setup 62*

Parts 1-8 on the first 8 white keys, 9-16 on the first 8 black keys, Groups are on the white keys under parts 14-16, and the Control Functions are on the remaining keys.

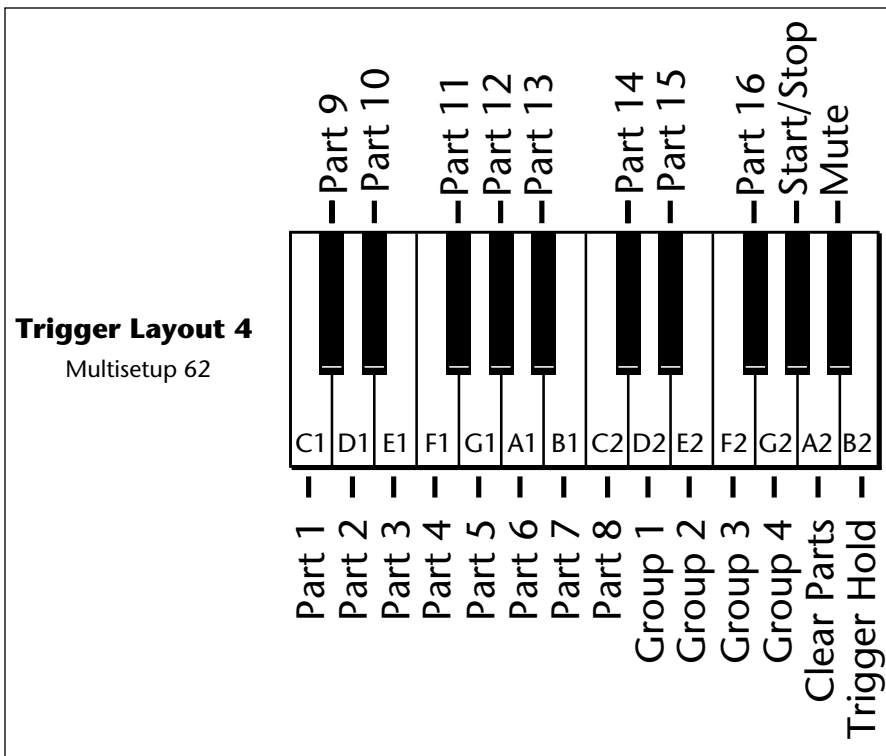

# Velocity Curves

This section provides diagrams and descriptions of the XL-1 velocity curves.

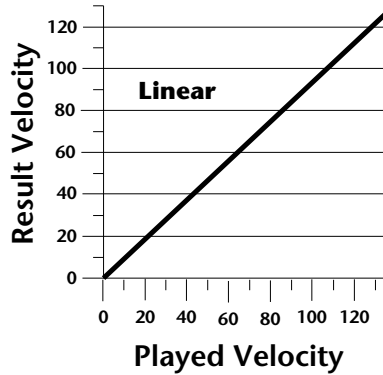

Linear, no change to velocity.

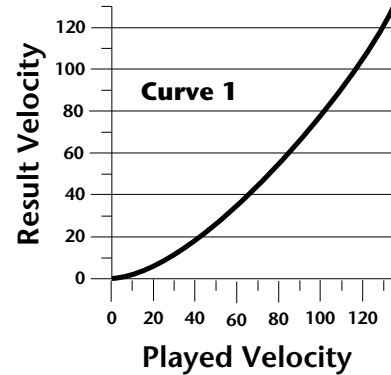

Compresses velocity range.

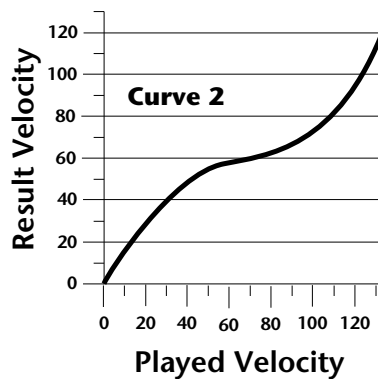

Expands dynamics in low range, emphasizing medium velocity values and compressing high velocity values.

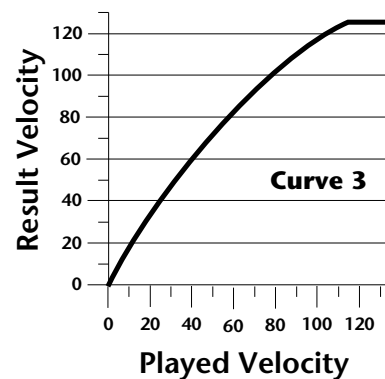

Expands velocity range. Soft -> Loud

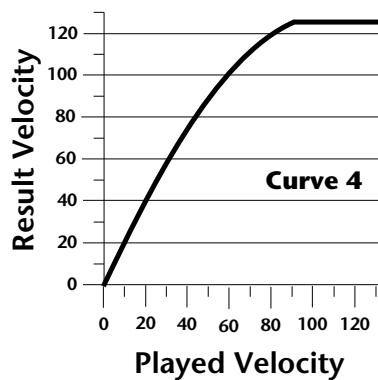

Expands velocity range. Outputs high values.

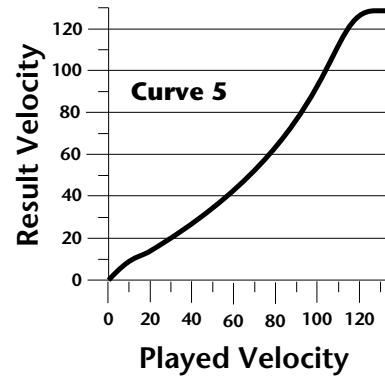

Shifts velocity values upward. Good dynamic range.



Velocity Curves

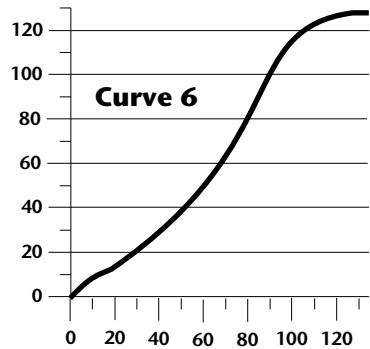

**Played Velocity**  
Shifts velocity values up while compressing the middle range.

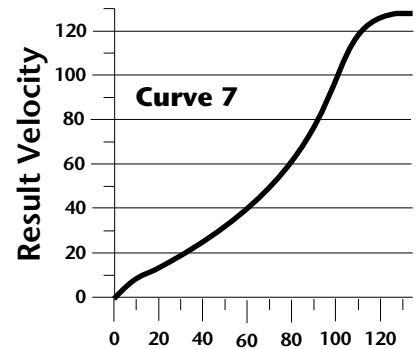

**Played Velocity**  
Similar to Curve 6.

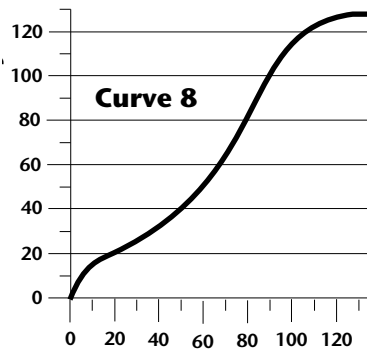

**Played Velocity**  
Similar to Curve 6 with more emphasis on the middle range.

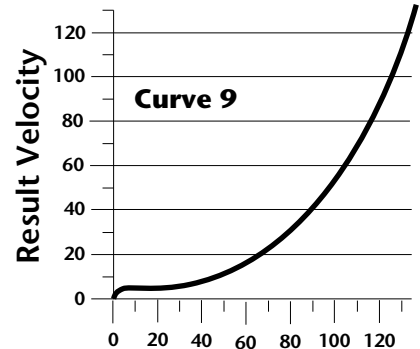

**Played Velocity**  
Extreme dynamic range compression.

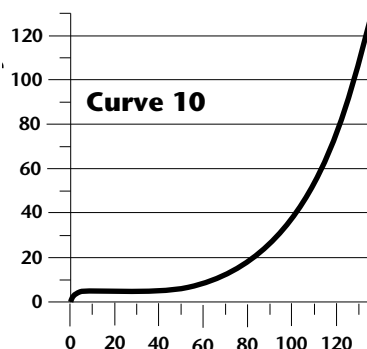

**Played Velocity**  
Extreme dynamic range compression. Outputs low values.

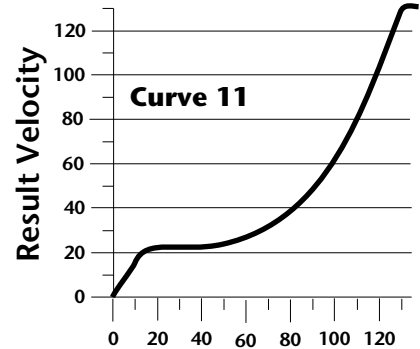

**Played Velocity**  
Extreme dynamic range compression. but doesn't output low values

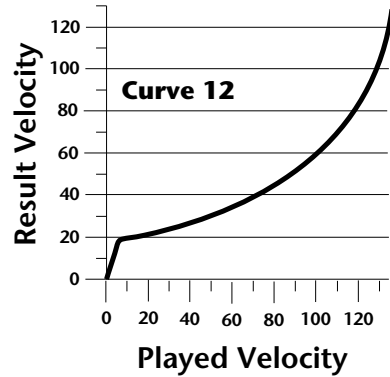

Less severe version of Curve 11.

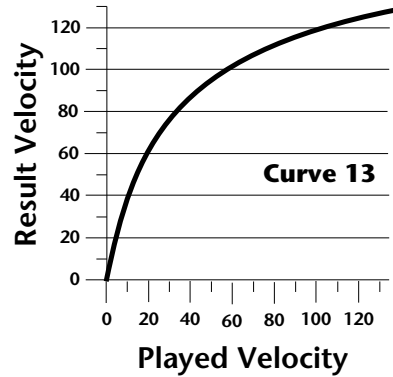

Extreme expansion of velocity range.

## PatchCord Amount Chart

The following chart shows the PatchCord “Amount” settings in order to get semitone intervals when modulation sources are connected to pitch.

Semitone	PatchCord Amount	Semitone	PatchCord Amount
1	3	21	66
2	6	22	69
3	approx. 9	23	approx. 72.5
4	approx. 12	24	approx. 76
5	16	25	79
6	19	26	82
7	22	27	88
8	25	28	91
9	28	29	approx. 95
10	approx. 31	30	98
11	35	31	
12	38	32	
13	41	33	
14	44	34	
15	47	35	
16	50	36	
17	approx. 53	37	
18	57	38	
19	60	39	
20	63	40	

# MIDI

## MIDI Implementation Chart

MIDI Information	Transmitted	Recognized	Remarks
MIDI Channels	---	1-16	
Note Numbers	---	0-127	
Program Change	---	0-127	
Bank Select Response?	No	Yes	MSB + LSB
Modes: Omni ( <i>Mode 1</i> )	No	Yes	
Mono ( <i>Mode 2</i> )	No	Yes	
Poly ( <i>Mode 3</i> )	No	Yes	
Mode 4 ( <i>Y/N</i> )	No	No	
Multi ( <i>Mode 5</i> )	No	Yes	
Note On Velocity	No	Yes	
Note Off Velocity	No	No	
Channel Aftertouch	No	Yes	
Poly (Key) Aftertouch	No	No	
Pitch Bend	No	Yes	
Active Sensing	No	No	
System Reset	No	No	
Tune Request	No	No	
System Exclusive	Yes	Yes	
Sample Dump Standard	No	No	
File Dump	No	No	
MIDI Tuning	Yes	Yes	
Master Volume	No	Yes	
Master Balance	No	No	
Notation Information	No	No	
Turn GM1 System On	No	No	
Turn GM2 System On	No	No	
Turn GM1 System Off	No	No	
Other ( <i>See Remarks</i> )	No	No	
NRPNS	No	No	
RPN 00 ( <i>Pitch Bend Sensi.</i> )	No	No	
RPN 01 ( <i>Chan. Fine Tune</i> )	No	No	
RPN 02 ( <i>Chan Coar. Tune</i> )	No	No	
RPN 03 ( <i>Tuning Prog Sel.</i> )	No	No	
RPN 04 ( <i>Tuning Bank Sel.</i> )	No	No	
RPN 05 ( <i>Mod Depth Rang</i> )	No	No	
<b>MIDI Timing &amp; Sync</b>			
MIDI Clock	No	Yes	
Song Position Pointer	No	No	
Song Select	No	No	
Start	No	Yes	
Continue	No	No	
Stop	No	Yes	

<b>MIDI Information</b>	<b>Transmitted</b>	<b>Recognized</b>	<b>Remarks</b>
MIDI Time Code	No	No	
MIDI Machine Control	No	No	
MIDI Show Control	No	No	
<b>Extension Capability</b>			
General MIDI Compat?	No	No	
Is GM default mode?	No	No	
DLS compatible?	No	No	
Import DLS Files?	No	No	
Export DLS Files?	No	No	
Import stand MIDI files	No	No	
Export stand MIDI files	No	No	
<b>NOTES:</b> Pan: -64 = hard left, +63 = hard right			

Product ID for XL-1 = 0F (15)

### **MIDI Device Inquiry Responses**

#### **Family**

MSB 0x04 (Musical Instruments)

LSB 0x04 (ROM Players)

#### **Member**

MSB 0x00 (P2k Group)

LSB 0x02 Audity 2000

0x03 Proteus 2000

0x04 B-3

0x05 XL-1

0x06 Virtuoso 2000

0x07 Mo-Phatt

There is only one edit buffer which is used by the current preset (the preset shown in the display). You can edit only one preset at a time via SysEx commands, although these presets can be edited independently of the current preset edited using the Front Panel. Remote Preset selection is independent of the edit buffer. Changing the current preset erases the edit buffer.

## Received Channel Commands

Channels number (n) = 0-15. Message bytes are represented in hex. All other numbers are decimal. Running Status is supported.

Command	Message	Comments
Note Off	8n kk vv	
Note On	9n kk vv	velocity 0 = note off
Key Aftertouch	An kk vv	kk = 0-127 vv = 0-127
Program Change	Cn vv	0-127
Channel Aftertouch	Dn vv	0-127
Pitch Bend	En ll mm	l = lsb, m = msb
Real-time Controller	Bn cc vv	cc = 00-31, 64-95
Footswitch	Bn cc vv	cc = 64-79, vv ≥ 64 = on
Volume	Bn 07 vv	0-127
Pan	Bn 0A vv	0=left, 127=right, 64=center
All Sound Off	Bn 78 00	turns all sound off
Reset All Controllers	Bn 79 00	ignored in omni mode
All Notes Off	Bn 7B 00	ignored in omni mode
Omni Mode Off*	Bn 7C 00	forces all notes & controls off
Omni Mode On*	Bn 7D 00	forces all notes & controls off
Mono Mode On (Poly Off)*	Bn 7E 00	forces all notes & controls off
Poly Mode On (Mono Off)*	Bn 7F 00	forces all notes & controls off
Bank Select MSB	Bn 00 bb	bb = bank MSB (see page 118)
Bank Select LSB	Bn 20 bb	bb = bank LSB (see page 118)

### \* Special Notes:

- **From Omni Mode** .....Omni Off turns Poly On.
- **From Poly Mode** .....Omni On turns Omni On; Mono On turns Mono On.
- **From Mono Mode** .....Mono Off turns Poly On; Omni On turns Omni On.
- **From Multi Mode** .....Omni On turns Omni On; Omni Off or Mono Off turns Poly On; Mono On turns Mono On.
- All other changes have no effect.

## SysEx Specification

XL-1 contains an extensive set of MIDI SysEx commands. (*Virtually every parameter is controllable via SysEx.*) Because of the size and technical nature of the System Exclusive specification, it is beyond the scope of this manual. The complete SysEx specification for XL-1 is available on the official E-mu Systems, Inc. web site: [www.emu.com](http://www.emu.com)

# Technical Specifications

<b>Audio Channels:</b>	64
<b>MIDI:</b>	MIDI In, MIDI Out, MIDI Thru
<b>MIDI Channels:</b>	16
<b>Presets:</b>	512 user presets. <i>(The number of ROM presets is determined by the sound SIMMs installed.)</i>
<b>Filters:</b>	6th Order (50 different types)
<b>Audio Outputs:</b>	2 polyphonic analog outputs, 20-bit $\Delta\Sigma$ DACs
<b>Max. Output Level:</b>	+4 dB
<b>Output Impedance:</b>	1000 Ohms
<b>Sound Memory:</b>	32 MB (expandable to 64 MB)
<b>Data Encoding:</b>	16-bit linear data
<b>Effects Engine:</b>	24-bit internal processing
<b>Sample Playback Rate:</b>	44.1 kHz
<b>Signal to Noise:</b>	>92 dB
<b>Dynamic Range:</b>	>90 dB
<b>Frequency Response:</b>	20 Hz - 20 kHz (+2/-1 dB)
<b>THD + Noise:</b>	< 0.02% (1kHz sine wave, A-weighting)
<b>IMD</b>	< 0.05%
<b>Stereo Phase</b>	Phase Coherent +/- 1° at 1 kHz
<b>Power Consumption:</b>	15 Watts
<b>Voltage Input:</b>	90VAC-260VAC at 50Hz-60Hz
<b>Dimensions</b>	H: 1.75 inches W: 19 inches L: 8.5 inches
<b>Weight</b>	6 lb., 14 oz. (3.1 Kg)

## Warranty

### **Please read this warranty, as it gives you specific legal rights.**

#### *Warranty*

This product is warranted, to the original consumer purchaser, to be free of all defects in workmanship and materials for a period of one (1) year from the date of such purchase from an authorized EMU dealer, provided that (a) the Warranty Registration Card is filled out and returned to EMU within 14 days of the purchase date, and (b) the EMU service center is provided a copy of the consumer purchaser's sales receipt.

#### *Warranty Restrictions*

Specifically, but without limitation, EMU does not provide warranty service for:

- Damages due to improper or inadequate maintenance, accident, abuse, misuse, alteration, unauthorized repairs, tampering, or failure to follow normal operating procedures as outlined in the owner's manual;
- Deterioration or damage of the cabinet;
- Damages occurring during any shipment of the unit;
- Any unit which has been modified by anyone other than EMU.

No other express or implied warranty is made, and EMU specifically disclaims any implied warranty of merchantability, satisfactory quality, and fitness for a particular purpose. EMU's liability under warranty is limited to repair or replacement of the unit, or refund, at EMU's option. In no event will EMU be liable for loss of revenue or savings, loss of time, interruption of use, or any other consequential, indirect, incidental, special or exemplary damages. The foregoing will apply notwithstanding the failure of essential purpose of any remedy provided herein. Some jurisdictions do not allow the exclusion of implied warranties or conditions, or limitations on how long an implied warranty or condition may last, so the above limitations may not apply. This warranty gives you specific legal rights. You may have other rights which vary from jurisdiction to jurisdiction.

#### *How To Obtain Warranty Service*

All EMU products are manufactured with the highest standards of quality. If you find that your unit does require service, it may be done by any authorized EMU service center. If you are unable to locate a service center in your area, please contact EMU's Service Department at (831) 438-1921. They will either refer you to an authorized service center in your area or ask that you return your unit to the EMU factory.

When returning your unit to the EMU factory, you will be issued a Return Merchandise Authorization (RMA) number. Please label all cartons, shipping documents and correspondence with this number. EMU suggests you carefully and securely pack your unit for return to the factory. (Do not send the power cord or operation manual.) Send the unit to E-mu Systems, Inc., 1600 Green Hills Road, Scotts Valley, CA 95066. You must pre-pay shipping charges to EMU; EMU will pay return shipping charges. You will be responsible for any damage or loss sustained during shipment in any direction.

3/99



# Index

## Symbols

- “+” modulation polarity 151
- “±” modulation polarity 151

## Numerics

- 19-tone tuning 161
- 1-bar trigger 50
- 2-pole filters 112
- 4-pole filters 112
- 6-pole filters 112

## A

- A effect types 179, 180
- absolute value processor 101
- aftertouch, mono 93
- algorithm
  - FXA 181, 182
  - FXB 181, 183
  - master FXA 78
  - master FXB 79
- all layers 121, 123
- alternate tuning 161
- amount, patchcord 116, 150
- amplifier 134
- amplitude 140, 168
- amplitude envelope 135
- amplitude modulation 92
- arp controls 57
- arp extension 57
- arp gate 57
- arp interval 57
- arp resolution 57
- arp velocity 57
- arp/beats mode 43
- arpeggiate multiple channels 70
- arpeggiator 40
  - channel 40
  - copying settings 195
  - delay 62, 63
  - duration 68
  - extension count 61
  - extension interval 61
  - factory patterns 59
  - gate time 60
  - key offset 67
  - key range 65
  - keyboard thru 64
  - latch mode 64
  - master parameters 57

- MIDI out 55
- MIDI song start 55, 65
- mode 58
- note value 59, 63
- pattern 56, 59
- pattern naming 69
- pattern speed 59
- recycle 64
- status 58
- sync 62
- user patterns 66
- velocity 60
- arpeggiator modes 56
- assign group 139
- attack, envelope 136, 145, 152, 172
- audition beats 46
- Audition Button 34
- Audition preset 25
- audition riff 164
- auxiliary envelope 95, 145

## B

- B effect types 179, 180
- balance 115
- band-pass filter 111, 141
- bandwidth 113
- bank 27
- bank number 27, 38
- Bank Organization 27
- Bank Select Display 34
- banks
  - selecting 39
- base tempo 44
- basic channel 46
- basic setup 22
- basics, programming 91
- beat busy 48
- beat markers 34, 44
- beat variation 49
- beat velocity group 1-4 48
- beat xpose group 1-4 48
- beats channel 47
- beats mode 43, 46
- beats part transpose 52
- beats part velocity 51
- beats parts group 53
- beats riffs 44
- beats trigger layout 50
- Beats trigger layouts 221
- beats trigger offset 51
- bend range 74
- breath controller 84
- bts
  - preset 28, 47
- bts busy 48
- button
  - control 33
  - cursor 34
  - edit menu 33

- home/enter 34, 43, 73
- master menu 33
- save/copy 34
- bypass effects 184

**C**

- calibration 87
- category
  - instrument 41
  - preset 41
- center frequency 113
- change
  - filter type 172
  - MIDI preset 83
  - preset 27
  - voice 165
- channel
  - arpeggiator 40
  - MIDI enable 82
  - MIDI select 38
  - pan 40
  - selection, MIDI 38
  - volume 39
- chorus 179, 189
  - width 167
- chorus, effect 189
- chorusing 137, 167
- clear part 44
- clock
  - divisor 93
  - MIDI 44
- clock modulation 99
- coarse tuning 134, 166
- comb filter 142, 180
- comb filter, effect 189
- connection instructions 22
- continuous controllers 116
- contour, envelope 93, 136
- control
  - button 33
  - data entry 35
  - effects multi mode 77
  - keys 45
  - mode 33
  - rows 33
  - volume 33
- controller
  - assigning real-time 83
  - footswitch 84
  - knobs 37, 83, 117
  - MIDI 83, 116
  - MIDI #10 40
  - MIDI #7 39, 116
  - MIDI real-time 116
  - modes 35
  - quick edit and real-time mode 36
  - real-time 33, 35
    - only mode 35

- standardized MIDI numbers 84
- copy preset patchcords 194
- copying
  - layers 192
  - patchcords 193
  - preset banks 195
  - presets 192
- create random preset 198
- crossfade random 94
- crossfade, ranges 130
- current tempo 44
  - offset 164
- cursor buttons 34
- curve
  - velocity 75
  - volume 167
- curve, glide 140
- cutoff frequency 111, 169

**D**

- damping, high frequency 180, 188
- data entry control 35
- DC offset, example 108
- DCA 115, 174
- decay
  - effect A 79, 180
  - effects 180
  - envelope 167
- deep edit mode 36, 86
- default assignment, beats 45
- delay 137
  - arpeggiator 62, 63
  - effect B 80
  - effect processor 190
  - effects 179, 180
  - LFO 148
  - master FXB 80
  - preset link 163
- demo sequences 25
- descending arpeggiator 56
- destinations, modulation 100, 152
- device, external MIDI 98
- device ID 81
- dimensions 230
- diode processor 102
- display, viewing angle 90
- distortion effects 179
- distortion, effect processor 190
- double and detune 137, 167
- doubling 189
- doubling, effect 189
- downbeat marker 34, 44
- dual channel beats 29, 46
- dual tap, delay 190
- duration, pattern 68
- dynamic filters 109
- dynamic range 230

**E**

- edit menu button 33
- editing
  - presets 165
  - user patterns 66
- effect
  - decay 180
  - FXA decay 79
  - FXA HF Damping 79
  - FXB->FXA 79
  - type B 80
- effect diagram 154, 155, 157
  - diagram 155
- effect sends 76
- effects
  - A type 179
  - B into effect A 186
  - B submix routing 80
  - B type 179
  - busses 177
  - by channel number 186
  - channel number setup 186
  - chorus 189
  - decay 180
  - delay 180, 190
  - description 188
  - distortion 190
  - doubling 189
  - dual tap delay 190
  - feedback 180, 190
  - flanger 189
  - FXB feedback 80
  - FxB>FxA 181
  - global 185
  - HF damping 180
  - LFO rate 80, 180
  - master 177, 182, 185
    - A algorithm 78
    - B algorithm 79
    - FxB>FxA 182
    - LFO rate 80
  - mode 77, 184
  - mode, bypass 184
  - multi mode control 77, 184
  - panning delay 190
  - patchcords 159
  - preset 154, 181
  - processor 177
  - programmed in the preset 154
  - programming in the preset 181
  - reverb 188
  - send amounts 177
  - sends 177
  - slapback 189
  - stereo delay 190
  - submix routing, A 79, 157, 158
  - type A 78, 156, 179, 180
  - type B 80, 157, 179, 180

- vibrato 190
- enabling MIDI channels 82
- enter button 34
- envelope
  - attack 136, 145, 152
  - auxiliary 145
  - decay 167
  - filter 143, 170, 171, 173
  - generator 93, 95
  - mode, factory 168
  - mode, filter 171
  - release 167
  - repeating 96
  - reverberation 188
  - volume 135, 136, 167, 168
- envelope generator
  - example 112
- equal temperment tuning 161
- errors, data transmission 88
- extension
  - count 61
  - interval 61

**F**

- factory
  - envelope mode 168
- factory patterns, arpeggiator 59
- Fc 143, 169
- feedback 180
  - effect 190
- feedback, FXB 80
- fills, beats 45
- filter
  - 2-pole 112
  - 4-pole 112
  - 6-pole 112
  - band-pass 111
  - bandpass 141
  - changing type 172
  - comb 142, 180
  - definition 110
  - dynamic 109
  - envelope 95, 143, 170, 171
  - envelope attack 172
  - envelope generator 143, 173
  - envelope mode 171
  - frequency 143, 152, 169
  - high-pass 110, 169
  - low-pass 110
  - mode 171
  - morph 114
  - notch 111
  - overview 169
  - parametric 113
  - pole 112
  - Q 143, 169, 170
  - swept EQ 113
  - troubleshooting 174
  - tutorial 109

- type 169, 172
- type, changing 172
- Z-plane 114, 115, 140
- fine tuning 134, 166
- fingered glide solo mode 139
- first key 104
- flange effects 179
- flanger, effect processor 189
- flashing LEDs 34, 44
- flip-flop processor 102
- footswitch 22, 84, 93
- free running, LFO 147
- frequency
  - center 113
  - cutoff 111
  - filter 143, 152
- frequency modulation 92
- front panel knobs 203
- FX cords 159
- FX mode 77, 184
- FXA algorithm 181, 182
- FXA Parameters 157
- FXB -> FXA 186
- FxB -> FxA 181, 182
- FXB Algorithm 157
- FXB algorithm 181, 183
- FXB master algorithm 79
- FXB parameters 158
- FXB submix routing 80

**G**

- gain processor 102
- gamelan tuning 161
- gate 93
- gate time 60
- generator
  - envelope 93
  - filter envelope 143, 173
  - noise and random 93
  - volume envelope 135
- glide 140
  - curve 140
  - key 93
  - rate 93, 140
- global effects 182, 185
- grooves
  - beat 45
- group, assigning channels to a 139
- groups, beats 45

**H**

- headphones 22
- HF Damping 79
- high frequency damping 180, 188
- high-pass filter 110, 169
- home position 27
- home/enter button 34, 43, 73

**I**

- ID number
  - sysex 81
- implementation chart, MIDI 227
- initial pan position 134
- initial volume 134
- instrument 115, 165
  - category 41
  - listing 211
  - selecting 124
- inverting LFO waves 98

**J**

- just C tuning 161
  - description 162
- just intonation 161

**K**

- key
  - glide 93
  - offset, arpeggiator 67
  - range, arpeggiator 65
  - sync 62
  - transpose 133
  - trigger 50
  - tuning 90
  - velocity 93
- key range 126
  - preset link 163
- keyboard
  - character assignments 122
  - key 93
  - layering and splitting 175
  - pressure 93
  - range 125, 126
  - splitting 175
  - thru, arpeggiator 64
  - transpose 133
  - transpose on/off 138
  - tuning 161
    - 19-tone 161
    - equal temperment 161
    - gamelan 161
    - just C 161
    - vallotti 161
- Kirnberger tuning 161
- knob
  - calibration 87
  - typical functions 203
- knob preset quick edit 85
- knobs
  - controller 37, 117
  - real-time control 35
  - transmit MIDI 35
- knobs MIDI out 86

**L**

- lag processor 101
- lagamount 103
- latch
  - beats part 50
- latch beats 29
- latch keys 44
- latch mode, arpeggiator 64
- layer
  - selecting 123
- layer, copying a 192
- layering presets 175
- layers
  - instrument 91
- layers, definition 123
- legato 138
- LFO 145
  - effect B 80
  - flanger 190
  - key sync 147
  - master FXB rate 80
  - rate 180
  - rate, effect 80
  - tricks & tips 146
  - trigger 98
  - variation 149
  - waveforms 97
  - waveshape 146
- link preset 163
- linking presets 163, 164, 175
- looping envelopes 96
- low frequency oscillator 93, 97, 145
  - delay 148
  - free running 147
  - sync 145, 147
  - variation 149
- low-pass filter 110
- low-pass filter, example 112

**M**

- main
  - screen 43, 73
- main screen 38
- master
  - arpeggiator parameters 57
  - bend range 74
  - effects 177, 182
  - FXA algorithm 78
  - FXB algorithm 79
  - menu button 33
- master arpeggiator 30
- master clock
  - current tempo 44
  - modulation 98
- master effect 185
- master menu 73
- Master Riff 46
- master riff 53

- master tempo 85
  - offset 164
- master tuning 74
- melody solo mode
  - (high) 138
  - (last) 138
  - (low) 138
- menu
  - master 73
  - save/copy 191
- MIDI 85
  - A-H messages 35
  - bank select display 25, 34
  - channel 38
  - channel selection 38
  - clock 44
  - continuous controllers 83, 93, 116
  - controller #7 39
  - device ID 81
  - enable 82
  - external clock 98
  - footswitches 84
  - implementation chart 227
  - in 22
  - inputs A & B 23
  - knobs transmit 35, 86
  - mode 42, 81, 177
  - multi mode 81
  - omni mode 81
  - out 23
  - out, arp/beats 55
  - pan control #10 40
  - poly mode 81
  - real-time controllers 116
  - receive program change 83
  - received channel commands 229
  - receiving sysex data 89
  - recording sysex data 89
  - send sysex data 89
  - song start 55, 65
  - standardized controller numbers 84
  - sync 55
  - Sysex data, sending 88
  - sysex packet delay 88
  - transmit, knob 86
- MIDI SysEx
  - send/receive 89
- minimoog, solo mode 139
- mix output 153, 178
- mod wheel 93
- mode
  - arpeggiator 58
  - arpeggiator latch 64
  - control 33
  - controller 35
  - deep edit 86
  - effect bypass 184
  - effects 77, 184
  - factory 168
  - filter envelope 171

- latch 64
- MIDI 81, 177
- mono 229
- multi 81, 177, 229
- non-transpose 138
- omni 81, 184, 229
- poly 81, 184, 229
- quick edit and real-time controller 36
- real-time controllers only 35
- solo 138
- time-based 171
- modulation
  - amplitude 92
  - clock 99
  - destinations 100
  - note-on 100
  - polarity 151
  - processors 101, 105
  - random 94
  - routing 150
  - sources 93, 94
  - sources & destinations 152
  - wheel 84
- modulation, definition 92
- mono aftertouch 93
- mono A-I, assign group 139
- mono mode 229
- morph filter 114
- multi channel arp 31
- multi mode 81, 177, 229
  - control, effects 184
  - effects control 77
- multimode map
  - send/receive 88
- multiple arpeggiators 70
- multiple trigger solo mode 138
- multisetup
  - saving 197
  - send/receive 88
- multi-timbral 42
- multitimbral operation 42
- mute beats 44

**N**

- naming a user pattern 69
- naming, preset 122
- noise & random generators 93
- noise and random generator 93
- non-transpose mode 138
- notch filter 111
- note value
  - arpeggiator 59, 63
- note-on modulation 100

**O**

- offset, arpeggiator key 67
- omni mode 81, 184, 229

- output
  - headphones 22
  - jack 22, 23
  - mix 153, 178
  - mono 22, 23
  - routing 153
- overall tuning, adjusting 74

**P**

- packet delay, MIDI sysex 88
- pan 115
  - channel 40
  - initial 134
  - preset link 163
- pan control 40
- panning delay, effect 190
- panning L/R 40
- parameters
  - effects 179
- parametric filters 113
- part
  - beat 44
- patchcord 94, 150
  - amount 150
  - copying a 193
  - routing 100
- patchcords, example 105
- patchord
  - amount 116
- pattern
  - arpeggiator 56, 59
  - duration 68
  - naming 69
  - repeat 68
  - speed 59
  - velocity 68
- patterns
  - arpeggiator user 66
- pedal 93
- performance controllers 93
- pink noise, example 107
- pitch wheel 93, 173
  - master bend range 74
- pitch wheel, range 153
- pitch, shifting 166
- pitchbend range 153
- play solo layers 164
- polarity, modulation and LFO 151
- polarity, ramp rate 104
- pole filters 112
- poly all, assign group 139
- poly mode 81, 184, 229
- poly, assign group 139
- portamento 140
- power 24
- power consumption 230
- Preset
  - audition 34

- preset
    - architecture 123
    - audition 25
    - category 27, 41
    - changing 27
    - copying 192
    - editing 165
    - effects 154, 181
    - links 163, 164, 175
    - listing 211
    - MIDI changes 83
    - naming 122
    - quick edit 85
    - random 198
    - saving a 191
    - selecting 26, 38
    - user 89
  - preset lag 103
  - preset ramp 103
  - processor
    - 4x gain 102
    - absolute value 101
    - diode 102
    - effect 177
    - flip-flop 102
    - modulation 105
    - quantizer 102
    - summing amp 101
    - switch 101
  - product description 9
  - program change, receive 83
  - program/preset map
    - send/receive 88
  - program->preset map 82
  - programming basics 91
- Q**
- Q 111, 142, 143, 169, 170, 172
- quantized 62
- quantizer 102, 108
- quantizer, example 107
- quarter note marker 34, 44
- quick edit 36
  - preset 85
- R**
- ramp rate 104
- random
  - creating presets 198
  - crossfade 94
  - crossswitch 131
  - generator, noise and 93
- random generator 93
- random modulation sources 94
- range
  - arpeggiator key 65
  - extension count 61
  - key 125, 126
  - keyboard 125
  - pitchbend 153
  - velocity 128
- rate
  - effect LFO 80, 180
  - glide 140
  - LFO 147
- rate, master FXB LFO 80
- rate/level envelopes 95
- real-time control of arps 57
- real-time controller
  - assignment 83
  - crossfading 130
  - mode, quick edit and 36
- real-time controllers 33, 35, 116
- real-time crossfade 130
- receive program change 83
- received channel commands, MIDI 229
- receiving MIDI SysEx data 89
- recording MIDI SysEx data 89
- rectifier 101
- release velocity 93
- release, envelope 167
- renaming an arpeggiator pattern 69
- repeat
  - arpeggiator pattern 68
  - pattern 68
- resonance 142, 143, 170, 172
- resonance, filter 111
- reverb 179, 188
- reverb, envelope 188
- riff
  - assignment 164
  - MIDI out 86
- riff beat marker 34, 44
- riff controllers 54
- riff loop marker 34, 44
- riff tempo 54
- riffs
  - playing 25, 34
- ROM card identifier 26
- routing
  - FXA submix 79, 157, 158
  - FXB submix 80
  - modulation 150
  - output 153
- S**
- safety instructions 11
- save
  - arp/beats 43
- save/copy button 34
- save/copy menu 191
- saving presets 191
- Scarlatti tuning 161
- screen
  - main 38, 43, 73
  - preset select 38

- screen viewing angle 90
- selecting a MIDI channel 38
- selecting presets 26, 38
- send
  - preset effect 153
- send amount
  - FXA 79, 157, 158
- send amounts 177
- sends
  - effect 76
- sequence
  - using multisetups in a 196
- setup
  - basic 22
  - studio 23
- signal path 115, 177
- slapback 189
- slapback, effect 189
- solo layer 164
- solo mode 138
- song start, MIDI 55, 65
- sound navigator
  - selecting instruments 124
- sound navigator 41
- sound start 137
- sources, modulation 152
- specifications, technical 230
- split keyboard 163
- splitting the keyboard 175
  - using links 175
- stack
  - presets 163
- stack layers 127
- standard MIDI switch number 85
- standard MIDI switch numbers 85
- standardized MIDI controller numbers 84
- start/stop groove 44
- status, arpeggiator 58
- step-by-step instructions 165
- stereo delay, effect 190
- stolen voices 139
- studio setup 23
- submix routing
  - FXB 80
- summing amp 101, 102
  - mod processor 101
- summing amp processor 101
- summing nodes 92
- superBEATS 44
- superbeats 43
- superbeats, definition 44
- swept EQ filter 113
- switch
  - mod processor 101
- switch processor 101, 105
- sync
  - arpeggiator 62
  - key 62
  - LFO 145, 147
  - MIDI song start 55

- synth solo mode
  - (high) 139
  - (last) 138
  - (low) 139
- system exclusive
  - device ID 81
  - ID 81
  - packet delay 88
  - send data 89

## T

- tap tempo 44
- technical specifications 230
- tempo offset 164
- tempo-based 135, 168
- tempo-based envelope 96, 144
- time
  - arpeggiator gate 60
  - master FXB delay 80
- time based envelope 95
- time-based 135, 168, 171
- time-based envelope 144
- transmission errors 88
- transmit MIDI, knob 86
- transpose 74, 133, 134
  - arpeggiator 61
  - preset link 163
- transpose, part 52
- trigger channel 47
- trigger key 44
- trigger keys 29
- trigger layout charts 221
- trighold 46
- troubleshooting, filter 174
- tune 74
- tuning 134, 166
  - 19-tone 161
  - coarse 166
  - equal temperament 161
  - fine 166
  - gamelan 161
  - just C 161
  - key 90
  - keyboard 161
  - Kimberger 161
  - vallotti 161
  - Werkmeister 161
- tuning tables
  - send/receive 88
- tutorial, filter 109
- tutorial, programming 165



**U**

- unlatch beats part 50
- user, presets 89
- user key tuning 90
- user pattern
  - arpeggiator 66
  - naming 69
  - repeat 68
  - velocity 68

**V**

- vallotti tuning 161
- variation, LFO 149
- velocity
  - arpeggiator 60
  - crossfade 128
  - curve 75, 224
  - key 93
  - preset link 163
  - release 93
  - user pattern 68
- vibrato, effect processor 190
- viewing angle 90
- viewing angle, screen 90
- voices, changing 165
- voices, stolen 139
- voltage setting 24
- volume
  - control 33
  - control #7 39
  - curve 167
  - envelope 115, 135, 136, 167, 168
  - preset link 163
- volume envelope 95
- volume, channel 39
- volume, initial 134

**W**

- waveform
  - inverting 98
- waveforms
  - LFO 97
- weight 230
- Werkmeister tuning 161
- wheel
  - modulation 84, 93
  - pitch 93, 173
- width, chorus 167

**X**

- X-factor (transpose) 52

**Z**

- Z-plane filter 114, 115, 140