



Owners Manual

© 2002 E-MU Systems

All Rights Reserved

FI12322 Rev. C

E-MU World Headquarters

E-MU Systems

1600 Green Hills Road
Scotts Valley, CA USA
95066
Telephone: 831-438-1921
Fax: 831-438-8612
Internet: www.emu.com

Europe, Africa, Middle East

E-MU Systems

Suite 6, Adam Ferguson House
Eskmills Industrial Park
Musselburgh, East Lothian
Scotland, EH21 7PQ
Tel: +44 (0) 131-653-6556
Fax: +44 (0) 131-665-0473

Important Notice:

In order to obtain warranty service on your XK-6 unit, the serial number sticker must be intact and you must have a sales receipt or other proof of purchase. If there is no serial number sticker on the XK-6, please contact E-MU Systems at once.

This product is covered under one or more of the following U.S. patents: 4,404,529; 4,506,579; 4,699,038; 4,987,600; 5,013,105; 5,072,645; 5,111,727; 5,144,676; 5,170,367; 5,248,845; 5,303,309; 5,317,104; 5,342,990; 5,430,244 and foreign patents and/or pending patents. All other trademarks belong to their respective companies. Specifications and features are subject to change without notice.

Table of Contents

Introduction	1
Product Description	1
Important Safety Instructions	3
Safety Instructions - German	6
Safety Instructions - French	8
Setup	13
Unpacking.....	13
Connection Instructions.....	14
Basic Setup	14
Performance Setup	15
Studio Setup	16
Instant Gratification	19
Playing Demo Sequences	19
Auditioning Presets	20
Selecting and Quick Editing Presets	20
Exploring Beats Mode	22
Exploring the Master Arpeggiator	24
Multi-Channel Arpeggiator	26
Time to Save?	28
Basic Operations	29
Power Switch	29
Volume Control	29
Channel +/- Buttons	29
Data Entry Control	29
Cursor Buttons	30
Pitch & Mod Wheels	30

Edit Section	30
Global Button	30
Controllers Button	30
Arp/Beats Button	31
MIDI Button	31
MIDI Panic Button	31
Audition Button	31
Compare Button	31
Save/Copy Button	31
Preset Edit Button	32
Home/Enter Button	32
Real-time Controller Knobs	32
Knob Functions	33
Quick Edit mode	33
Screen View Buttons	34
Main	34
Multi	34
Mix Screen	34
Demo Mode	35
Command Functions	36
Preset Selection	36
Trigger Mode	36
Preset Menu Jump Keys	36
Main Screen	37
MIDI Channel Selection	37
Preset Selection	37
Channel Volume	38
Channel Pan	39
Channel Arpeggiator	39
Sound Navigator	40
Preset Category	40
Instrument Category	40
Multisetups	41
Restoring Multisetups	41
Multisetup Name	42
Saving Multisetups	42
Arp/Beats Menu	43
Beats	44
Beats Mode	46
Status	46
Beats Channel	46
Trigger Channel	46
Beats Controllers	49
Beat Velocity Group 1-4	49
Beat Xpose Group 1-4	49
Beat Busy	49
Beat Variation	50

Beats Keys Layout	51
1-Bar Trigger Option	51
Beats Keys Offset	52
Beats Part Velocity	52
Beats Part Transpose	53
Beats Part Group	54
Master Riff	54
Riff Tempo	55
Riff Controllers	55
MIDI Song Start	56
Arp/Riff MIDI Out	56
Arpeggiators	57
Arp Controllers	58
Arpeggiator Resolution.....	58
Arpeggiator Extension	58
Arpeggiator Velocity.....	58
Arpeggiator Gate	58
Arpeggiator Interval	58
Master Arpeggiator Parameters	58
Status	59
Mode	59
Note Value	60
Arpeggiator Pattern Speed	60
Pattern	60
Velocity	61
Gate Time	61
Extension Count	62
Extension Interval	62
Sync	63
Pre-Delay	63
Duration	64
Post-Delay	64
Recycle	65
Keyboard Thru	65
Latch	65
Send MIDI System Exclusive Data	66
Editing a User Arpeggiator Pattern	67
Pattern Step Number	67
Key	67
Key Offset	68
Tie	68
Rest	68
Skip	68
End	68
Velocity	69
Duration	69
Repeat	69
User Pattern Name	70
Multichannel Arpeggiating.....	70

Controllers Menu	71
Realtime Control Functions	72
Keyboard Channel	72
Keyboard Transpose	72
Local Control On/Off	72
Keyboard Velocity Curve	73
Channel Aftertouch On/Off	74
Footswitch Function	74
Foot Pedal Function	75
Trigger Buttons Function	75
Trigger Buttons	76
Trigger Button Select	76
Latch on/off	76
MIDI Key	76
MIDI Channel	76
Velocity	76
Preset Select Buttons	77
Trigger Button Select	77
Preset Location	77
Preset Number	77
Preset Name	77
Category	77
Preset Select Send Buttons	78
Trigger Button Select	78
Bank MSB	78
Program Change Number	78
Bank LSB	78
Knob Preset Quick-Edit	79
Real-time Controller Assignment	79
MIDI Footswitch Assign	80
Calibrate Controllers	80
Tempo Controller	81
Base Tempo	82
Global Menu	83
Defining Global Parameters.....	84
Master Transpose/Tune	84
Master Bend Range	84
Master Velocity Curve	85
Mix Output	86
Master Effects.....	88
Effects Mode	88
Effects Multi Mode Control	88
Master FXA Algorithm	89
A Effect Types	89
FXA Parameters: Decay/HF Damping FxB -> FxA	90
FXA Send Amounts	90
Master FxB Algorithm	90
B Effect Types	91

FXB Parameters: Feedback/LFO Rate Delay Time	91
FXB Send Amounts	91
Miscellaneous Parameters	92
Edit All Layers Enable	92
User Key Tuning	92
Screen Viewing Angle	92
MIDI Menu	93
Keyboard Outputs MIDI	94
Knobs Output MIDI	94
Transmit MIDI Clock	94
MIDI Enable	94
Receive Program Change	95
MIDI Program Change -> Preset	95
MIDI SysEx ID	96
MIDI SysEx Packet Delay	97
Send MIDI System Exclusive Data	97
MIDI Mode	98
Programming Basics	99
Modulation	100
Modulation Sources	101
Random Sources	102
Modulation PatchCords.....	102
Envelope Generators.....	103
Tempo-based Envelopes	104
Envelope Repeat	104
Low Frequency Oscillators (LFOs)	105
Clock Modulation	106
Modulation Destinations.....	108
Modulation Processors.....	109
Preset Modulation Processors	111
Using the Modulation Processors	113
More Examples	115
Dynamic Filters	117
What is a Filter?	118
Parametric Filters	121
The Z-Plane Filter	122
Signal Flow	123
MIDI Channels & Real-time Controls	124
Bank Select Commands	126
Stereo Mix Outputs	127

Preset Edit Menu	129
Preset Name	130
Four Layer Architecture	130
Selecting Layers	131
Defining Layer Parameters.....	132
Selecting an Instrument	132
Sound Navigator	132
Defining Key Range	133
Defining the Velocity Crossfade Range	135
Defining the Real-time Crossfade Range	137
Transposing the Instrument	140
Tuning	141
Background: Transpose vs. Coarse Tuning	141
Amplifier	141
Volume Envelope	142
Selecting the Mode	142
Defining the Volume Envelope	143
Chorusing the Layer	144
Sound Start Offset and Delay	144
Non-Transpose Mode	145
Solo Mode	145
Assign Group	146
Glide	147
Z-Plane Filters	148
XK-6 Filter Types	148
Filter Types	148
Filter Parameters	150
Filter Envelope	151
Defining the Filter Envelope	152
Auxiliary Envelope	152
Low Frequency Oscillators (LFOs)	153
Shape	153
Sync	154
Rate	154
Delay	156
Variation	156
PatchCords	157
Modulator Polarity	158
Pitch Bend Range	160
Mix Output	160
Common Preset Parameters.....	161
Preset Effects	161
FXA Algorithm	163
A Effect Types	163
FXA Parameters	164
FXA Send Amounts	164
FXB Algorithm	164
B Effect Types	164
FXB Parameters	165

FXB Send Amounts	165
Preset Patchcords	165
Initial Controller Amount	167
Keyboard Tuning	168
Preset Links	170
Preset Tempo Offset	171
Audition Riff Selection	171
Play Solo Layers	171
Effects	173
Effects Overview.....	173
The Effects Sends	173
Effect Types	175
Effect Parameters	175
Decay	176
High Frequency Damping	176
Feedback	176
LFO Rate	176
Delay	176
Effects Programmed in the Preset	177
Master Effects	178
Effects Mode	180
Flexible Effects Control	180
Using the Effects Channel Settings in Multi Mode	182
Effect B Into Effect A	182
General Effect Descriptions.....	184
Reverb	184
Chorus	185
Doubling	185
Slapback	185
Stereo Flanger	185
Delay	186
Stereo Delay	186
Panning Delay	186
Dual Tap	186
Vibrato	186
Distortion	186
Save/Copy Menu	187
Saving a Preset	187
Copying Information.....	188
Copy Preset	188
Copy Layer	188
Copy PatchCords	189
Copy Preset PatchCords	190
Copy Arpeggiator Settings	190
Copy Arpeggiator Pattern	191
Copy Preset Bank	191

Sound Authoring	192
Rename Flash SIMM	193
Duplicate Flash	194
Create Random Preset	195
Preset Programming	197
Editing Presets.....	197
Changing the Instrument	197
Changing the Tuning of an Instrument	198
Chorus	199
Volume Envelope	199
Working with Filters	202
Adding the Filter Envelope	203
Changing Filter Types	205
Envelope Repeat	206
Practice Modulating	206
Troubleshooting	207
Linking Presets.....	208
Appendix	209
Front Panel Knob Functions.....	209
Knob Controller Descriptions	210
Jam Presets	210
Preset Listing.....	211
Instrument Listing.....	216
Riff Listing.....	226
Keyboard Velocity Curves.....	229
Master Velocity Curves	232
PatchCord Amount Chart	234
E-MU Expansion Sound Sets.....	235
Installing Sound SIMMs.....	237
MIDI.....	239
Received Channel Commands	246
Technical Specifications.....	247
Warranty	248
Index	251



Introduction

Product Description

Upgradable Sounds

XK-6 contains a thorough collection of Electronica/Dance presets. These sounds are rich in harmonic texture and a perfect complement to the Z-plane filters. XK-6 contains three additional, user-upgradable sound SIMM sockets, allowing you to mix and match sound sets according to your needs. New sounds can be added as easily as plugging in a new 16MB or 32MB SIMM module. Each E-MU sound set has been meticulously crafted to be the finest of its kind. Samples are expertly matched across the keyboard and perfectly looped to create realistic instruments which form the exceptionally playable presets.

1024 Presets & more

XK-6 contains 512 user presets and 512 factory ROM presets, but it can be expanded with literally thousands of ROM presets. *(ROM presets are automatically added when sound SIMMs are installed. As an example, a 32 MB SIMM may contain up to 1024 ROM presets.)* XK-6's Sound Navigator makes it easy to find the exact sound you want. It's powerful, yet simple to use.

Velocity & Pressure Sensitive Keyboard

The five-octave, velocity sensitive keyboard with aftertouch allows you to perform live or record via MIDI into an external computer/sequencer. The keyboard action is extremely responsive, capturing all the subtle nuances of your performance.

Multi-Function Controllers

Multi-function buttons allow you to trigger arpeggiators and notes internally or on any of your other MIDI devices. They can act as preset select buttons or Beats Mute or MIDI Trigger buttons (latched or unlatched).

Four real-time controller knobs are also multi-function controls. These knobs make it a snap to edit and modify internal preset parameters. The controllers are fully programmable and can control internal preset or other MIDI equipment. They can also be programmed to adjust multiple internal parameters at once, allowing complex levels of control. For example, a single knob can simultaneously turn up filter cutoff, while detuning one sample, and adjusting the release time of the volume envelope. Virtually

every synth parameter in the XK-6 is controllable using the real-time knobs or by any internal or external control source.

SuperBeats

Beats Mode is a whole new way to create dynamic, original music. With Beats, you trigger, latch and unlatch synced loops and grooves from the sixteen trigger keys. Simply select a **bts**: preset and go. Then use XK-6's performance controls to alter and mutate the rhythm or the sound itself.

Multi-Channel Arpeggiators

XK-6's Rhythmic Pattern Generator/Arpeggiator can play up to 16 synchronized arpeggiator patterns at once using a different sound for each! Patterns can be edited using pattern flow commands such as: delay for 2 bars, play for 4 bars, hold for 2 beats and repeat. You can program or download 100 user patterns in addition to the 200 factory patterns.

Ultra Powerful Synthesizer

The extremely flexible yet easy to use synthesizer makes it easy to build sounds of any kind. Up to 4 four layers can be switched or crossfaded using key position, velocity, real-time controllers or any modulation source. 64 voice polyphony ensures that you can play and sequence the most complex material. XK-6 also contains 50 different 2nd to 12th order resonant & modeling filters which are used to shape and modify over 1200 waveforms contained in 32 megabytes (MB) of ROM.

Sixty-four modulation sources include three multistage envelopes and two LFOs per layer, as well as full MIDI control over virtually every parameter. The digital patch bay, with 24 cords per layer, (and 12 more cords per preset) lets you connect modulation sources to 64 destinations in any imaginable way. The patch bay also contains a set of arithmetic modifiers, allowing you to create complex synthesis models. Synth parameters as well as arpeggiator and BEAT tempos can be controlled from XK-6's internal clock (or an external MIDI clock). Up to 8 LFOs and 12 envelopes can be perfectly synchronized at different rates.

24-bit Effects

Once you have created your preset, you can add richness to your sound using XK-6's 24-bit stereo effects. You can choose a different effects setup for each preset from over 60 algorithms. XK-6's effects section is actually two separate effects processors with control over each wet/dry mix level on four effects sends. Effects Processor "A" contains primarily ambiance algorithms like reverb and delays, while effects processor "B" contains primarily spectral algorithms such as chorus, flange, phase, distortion, and delay. Effects can be linked to each preset or used globally for increased flexibility.

Other features include multiple solo, voice assignment and performance modes for expressive control, 12 user-definable alternate tunings, and, of course, an extensive MIDI implementation.

Important Safety Instructions

Use in countries other than the U.S.A. may require the use of a different line cord or attachment plug, or both. Refer all servicing to qualified service personnel. There are no user serviceable parts or adjustments inside the unit. There are no user serviceable parts inside the power supply enclosure.

WARNING: To reduce the risk of fire or electric shock, do not expose this product to rain or moisture.

Grounding Instructions

This product must be grounded. If it should malfunction or break down, grounding provides a path of least resistance for electric current, reducing the risk of electric shock. This product is equipped with a cord having an equipment-grounding conductor and a grounding plug. The plug must be plugged into an appropriate outlet properly installed and grounded in accordance with all local codes and ordinances.

Danger!

Improper connection of the equipment's grounding conductor can result in the risk of electric shock. Check with a qualified electrician or service personnel if you are in doubt as to whether the product is properly grounded. Do not modify the plug provided with this product. If it will not fit the outlet, have a proper outlet installed by a qualified technician.

User Maintenance Instructions

1. The XK-6 should be kept clean and dust free. Periodically wipe the unit with a clean, dry, lint free cloth. Do not use solvents or cleaners.
2. There are no user lubrication or adjustment requirements.

Caution -*Servicing instructions are for use by qualified personnel only. To reduce the risk of electric shock, do not perform any servicing other than that contained in these operating instructions unless you are qualified to do so. Refer all servicing to qualified service personnel.*

INSTRUCTIONS PERTAINING TO A RISK OF FIRE, ELECTRIC SHOCK, OR INJURY TO PERSONS

Important Safety Instructions
User Maintenance Instructions



This symbol is intended to alert you to the presence of important operating and maintenance (servicing) instructions in the literature accompanying the unit.

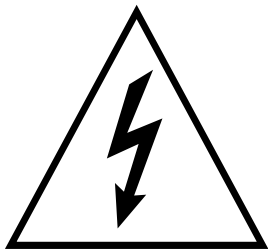

This symbol is intended to alert you to the presence of uninsulated dangerous voltage within the product's enclosure that may be of sufficient magnitude to constitute a risk of electric shock to persons.



This symbol is intended to alert you to use caution when moving a cart/apparatus combination to avoid injury.

READ THESE INSTRUCTIONS: When using electric products, basic precautions should always be adhered to, including the following:

1. Read all instructions before using XK-6.
2. Keep these instructions.
3. Heed all warnings.
4. Follow these instructions.
5. Do not use near water.
6. Clean only with a dry cloth.
7. Install in accordance with E-MU's instructions. Do not block any openings. This apparatus should be situated so that its location or position does not interfere with proper ventilation. The ventilation should not be impeded by covering the ventilation openings with items such as newspapers, tablecloths, curtains, etc.
8. Do not install near any heat sources such as radiators, heat registers, stoves, or other apparatus (including amplifiers) which produce heat.
9. Do not defeat the safety purpose of the polarized or grounding-type plug. A polarized plug has two blades with one wider than the other. A grounding-type plug has two blades and a third grounding prong. The wide blade or the grounding prong are provided for your safety. If the provided plug does not fit into your outlet, consult an electrician for replacement of the obsolete outlet.
10. Protect the power cord from being walked on or pinched, particularly at plugs, convenience receptacles, and at the point where they exit from the apparatus.
11. Use only attachments/accessories specified by E-MU Systems.
12. Use only with the cart, stand, tripod, bracket, or table specified by E-MU or sold with the apparatus. When a cart is used, use caution when moving the cart/apparatus combination to avoid injury from tip-over.
13. Unplug the XK-6 from the power outlet during lightning storms or when left unused for a long period of time.
14. Refer all servicing to qualified service personnel. Servicing is required when the apparatus has been damaged in any way, such as power supply cord or plug is damaged, liquid has been spilled or objects have fallen into the apparatus, the apparatus has been exposed to rain or moisture, the does not operate normally or has been dropped.
15. No open flame sources, such as lit candles, should be placed on the apparatus.
16. The apparatus is designed for use in moderate climates.
17. The apparatus shall not be exposed to dripping or splashing. No objects filled with liquids, such as vases, shall be placed on the apparatus.
18. To reduce the risk of injury, close supervision is necessary when using the apparatus near children.
19. The apparatus should be connected only to a power supply of the type described in the operating instructions and marked on the product.

Radio and Television Interference

20. This product, in combination with an amplifier and headphones and speakers, may be capable of producing sound levels that could cause permanent hearing loss. Do not operate for a long period of time at a high volume level or at a level that is uncomfortable. If you experience any hearing loss or ringing in the ears, consult an audiologist.

The equipment described in this manual generates and uses radio-frequency energy. If it is not installed and used properly—that is, in strict accordance with our instructions—it may cause interference with radio and television reception.

This equipment has been tested and complies with the limits for a Class B computing device in accordance with the specifications in Subpart J of Part 15 of the FCC rules. These rules are designed to provide reasonable protection against such interference in a residential installation. However, there is no guarantee that the interference will not occur in a particular installation, especially if a “rabbit ear” TV antenna is used.

If XK-6 does cause interference to radio or television reception, you can try to correct the interference by using one or more of the following measures:

- Turn the television or radio antenna until the interference stops.
- Move XK-6 to one side or the other of the television or radio.
- Move XK-6 farther away from the television or radio.
- Plug XK-6 into an outlet on a different circuit than the television or radio.
- Consider installing a rooftop antenna with a coaxial lead-in between the antenna and television set.

Copyright Information

It is the policy of E-MU Systems to allow all users free, complete and unrestricted use to all of the presets, beats, riffs, patterns, and audition files contained in our products. However, we are unable to grant you a license to re-use, modify, create derivative works from, sell or redistribute the demonstration files (demos). In most cases, these compositions are copyright protected by their respective authors and are licensed to E-MU Systems for product demonstration purposes only. Please contact E-MU Systems with additional questions.

Safety Instructions - German

Wichtige Sicherheitsvorschriften

In Ländern ausserhalb den U.S.A. können andere Kabel oder Stecker notwendig werden. Zur Verminderung des Risikos von Feuer oder eines elektrischen Schlages übergebe man den Service an qualifizierte Fachleute. Das Gerät niemals Regen oder Nässe aussetzen.

Erdungsinstruktionen

Das Gerät muss geerdet sein. Bei einem Defekt oder Ausfall bietet Erdung dem elektrischen Strom den Weg des geringsten Widerstandes und reduziert das Risiko eines Schlages. Dieses Gerät ist mit einem geerdeten Kabel und Stecker ausgerüstet. Der Stecker muss in eine passende, einwandfrei montierte und geerdete Steckdose in Übereinstimmung mit den örtlichen Vorschriften eingeführt werden.

Gefahr

Unvorschriftsgemässer Anschluss des Gerätes kann zum Risiko eines elektrischen Schlages führen. Im Zweifelsfalle über die ordnungsgemässe Erdung soll ein qualifizierter Elektriker oder eine Serviceestelle beigezogen werden. Ändern Sie den mitgelieferten Stecker nicht. Sollte er nicht in die Steckdose passen, soll die einwandfreie Installation durch einen qualifizierten Techniker erfolgen.

Unterhaltsinstruktionen für anwender

1. XK-6 (Modell Nummer 9726) soll sauber und staubfrei gehalten werden. Das Gerät mit einem sauberen und säurefreien Tuch periodisch abreiben. Keine Lösungs- oder Reinigungsmittel anwenden.
2. Schmierer und Justieren sind nicht notwendig.
3. Bei weiteren Servicefragen wende man sich an eine qualifizierte Servicestelle.

Vorsicht

Diese Gebrauchsanweisungen sind nur für qualifizierte Techniker beabsichtigt. Um die Gefahr eines elektrischen Schlages zu vermeiden, sollen Sie keine Arbeit unternehmen, die nicht in diesen Instruktionen vorgeschrieben ist. Wenden Sie Sich bei weiteren Servicefragen an eine qualifizierte Servicestelle.



Dieses Symbol weist den Anwender auf wichtige Gebrauchs- und Service-Vorschriften in den beiliegenden Drucksachen.

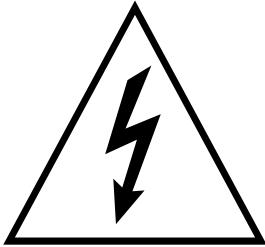

Dieses Symbol verweist auf nicht-isolierte Stromspannungen im Geräte-Innern, welche zu einem elektrischen Schlag führen könnten.

INSTRUKTIONEN BETR. FEUERRISIKO, ELEKTROSCHOCK ODER VERLETZUNG VON PERSONEN

WARNUNG; Beim Einsatz elektrischer Geräte sollten folgende Vorsichtsmassregeln stets beachtet werden:

1. Lesen Sie vor dem Einschalten des XK-6 alle Instruktionen.
2. Zur Vermeidung von Verletzungsrisiken müssen Kinder bei eingeschaltetem XK-6 sorgfältig überwacht werden.
3. XK-6 nicht in der Nähe von Wasser in Betrieb nehmen -- z.B. in der Nähe von Badewannen, Waschschüsseln, auf nassen Gestellen oder am Swimmingpool.
4. XK-6 stets so aufstellen, dass seine Belüftung nicht beeinträchtigt wird.
5. XK-6 nicht in der Nähe von Hitze aufstellen, wie Heizkörper, offenem Feuer, Öfen oder von Backöfen.
6. XK-6 ausschliesslich mit einem Netzgerät gemäss Bedienungsanleitung und Gerätemarkierung verwenden.
7. Dieses Gerät kann bei Verwendung von Kopfhörern und Verstärkern hohe Lautpegel erzeugen, welche zu bleibenden Gehörschäden führen. Arbeiten Sie nicht während längerer Zeit mit voller Lautstärke oder hohem Lautpegel. Stellen Sie Hörverlust oder Ohrenläuten fest, wenden Sie sich an einen Ohrenarzt.
8. XK-6 kann mit einem polarisierten Kabelstecker (mit ungleichen Stiften) ausgerüstet sein. Das geschieht für Ihre Sicherheit. Können Sie den Stecker nicht in die Steckdose einführen, ändern Sie nicht den Stecker ab, sondern wenden Sie sich an einen Elektriker.
9. Das Netzkabel des XK-6 bei längerem Nichtgebrauch aus der Steckdose ziehen.
10. Vermeiden Sie sorgfältig das Eindringen von Gegenständen oder Flüssigkeiten durch die Gehäuseöffnungen.
11. Das Gerät soll durch qualifizierte Serviceleute gewartet werden, falls:
 - A. das Netzkabel beschädigt wurde, oder
 - B. Gegenstände oder Flüssigkeit in das Gerät gelangten,
 - C. das Gerät Regen ausgesetzt war, oder
 - D. das Gerät nicht normal oder einwandfrei arbeitet, oder
 - E. das Gerät stürzte oder sein Gehäuse beschädigt wurde.
12. Servicearbeiten sollten nur qualifizierten Fachleuten anvertraut werden.

Safety Instructions - French

Instructions de Sécurité Importantes

Une utilisation dans des pays autres que les U.S.A. peut nécessiter l'usage d'un cordon d'alimentation différent. Afin de réduire les risques d'incendie ou d'électrocution, référez-vous à un personnel de service qualifié, et n'exposez pas cet appareil à la pluie ou à l'humidité.

Instructions de Mise à la Terre

Cet appareil doit être relié à la terre. Dans le cas d'une malfonction éventuelle, la terre fournit un passage de moindre résistance pour le courant électrique, réduisant ainsi les risques d'électrocution. Le est équipé d'un cordon muni d'un conducteur et d'une fiche devant être branchée dans une prise appropriée et reliée à la terre en conformité avec les normes locales.

Danger

Une connexion incorrecte peut résulter en des risques d'électrocution. Vérifiez avec un technicien qualifié si vous avez des doutes quant à la connexion. Ne modifiez pas vous-même le cordon d'alimentation livré avec cet appareil; s'il ne rentre pas dans la prise, faites-en installer un autre par un technicien qualifié.

Instructions de Maintenance

1. Le XK-6 (Model 9726) doit être maintenu propre et sans poussière. Nettoyez-le périodiquement à l'aide d'un chiffon propre et non-pelucheux. N'utilisez pas de solvants, ou d'autres produits de nettoyage.
2. Aucune lubrification et aucun réglage ne sont nécessaires de votre part.
3. Pour tout autre service, référez-vous à un personnel qualifié.

Instructions Concernant les Risques d'Incendie, d'Electrocution, ou de Blessures Corporelles.

ATTENTION: Lorsque vous utilisez des appareils électriques, certaines précautions élémentaires doivent toujours être prises, incluant les suivantes:



Ce symbole vous alerte de la présence d'instructions importantes d'opération et de maintenance dans la notice accompagnant l'appareil.

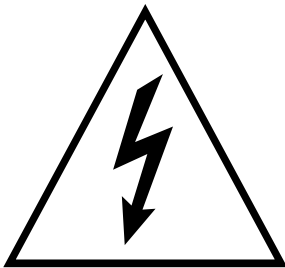

Ce symbole vous alerte de la présence d'un voltage non-isolé dangereux à l'intérieur de l'appareil, pouvant être d'une magnitude suffisante pour constituer un risque d'électrocution.

Ces instructions de dépannage sont destinées uniquement aux personnes qualifiées. Afin d'éviter les risques d'électrocution, n'effectuez que les opérations décrites dans ce manuel, à moins que vous ne soyez qualifié pour cela. Faites effectuer toute réparation par une personne qualifiée.

1. Lisez bien toutes les instructions avant d'utiliser le XK-6.
2. Afin de réduire les risques de blessures, une attention particulière est nécessaire en la présence d'enfants en bas âge.
3. N'utilisez pas le XK-6 dans ou près d'endroits humides - par exemple près d'une baignoire, d'un lavabo, dans les toilettes, dans une cave humide, sur un bar fréquenté, en présence d'un bull-dog en rut, ou dans une piscine pleine. Protégez cet appareil de tout liquide, éclaboussure ou fuite.
4. Le XK-6 doit être placé de façon à ce que sa position n'interfère pas avec sa propre ventilation.
5. Le XK-6 doit être placé loin de sources de chaleur telles que des radiateurs, cheminées, fours, ou groupies en chaleur.
6. Le XK-6 doit uniquement être connecté à une alimentation du type décrit dans les instructions d'opération et tel qu'indiqué sur l'appareil.
7. Une attention particulière doit être observée quant aux objets pouvant tomber et aux liquides pouvant être versés sur et à l'intérieur de le XK-6.
8. Le XK-6 peut être équipé d'une fiche secteur polarisée (avec une broche plus large que l'autre). C'est une mesure de sécurité. Si vous ne pouvez pas brancher cette fiche dans une prise, ne neutralisez pas cette sécurité. Contactez plutôt un électricien pour remplacer la prise obsolète.
9. Evitez de marcher sur le cordon d'alimentation ou de le coincer, particulièrement près des prises de courant, des boîtiers électriques du point de sortie de l'appareil.
10. Le cordon d'alimentation de le XK-6 doit être débranché lorsque ce dernier n'est pas utilisé pendant une longue période.
11. Cet appareil, combiné avec un amplificateur, des haut-parleurs, et/ou un casque, est capable de générer des niveaux sonores pouvant occasionner une perte de l'ouïe permanente. Ne travaillez pas trop longtemps à un volume trop élevé ou même inconfortable. Si vous observez une perte de l'audition ou un bourdonnement dans les oreilles, consultez un O.R.L.
12. N'utilisez que les accessoires spécifiés par E-MU Systems.

Interférences Radio et Télévision

13. Cet appareil doit être examiné par un personnel qualifié lorsque:
 - A. Le cordon d'alimentation a été endommagé, ou
 - B. Des objets sont tombés, ou du liquide a été versé sur/à l'intérieur de l'appareil, ou
 - C. Le XK-6 a été exposé à la pluie, ou
 - D. Le XK-6 est tombé, ou
 - E. Le XK-6 ne fonctionne pas normalement, ou affiche un changement radical de performance.
14. Tout service doit être effectué par un personnel qualifié.

SAUVEGARDEZ CES INSTRUCTIONS

L'appareil décrit dans cette notice génère et utilise une énergie de fréquence-radio. S'il n'est pas installé et utilisé correctement - c'est à dire en suivant strictement nos instructions - il peut occasionner des interférences avec la réception d'une radio ou d'une télévision.

Cet appareil a été testé et est conforme aux normes de Classe A en accord avec les spécifications du paragraphe J de la section 15 des lois FCC. Ces lois sont désignées pour fournir une protection raisonnable contre de telles interférences dans une installation résidentielle. Toutefois, il n'est pas garanti qu'aucune interférence n'apparaisse dans des installations particulières, et plus spécialement lorsqu'une antenne de télévision en «oreilles de lapin» est utilisée.

Si le XK-6 occasionne des interférences, vous pouvez essayer de les corriger en utilisant une ou plusieurs des mesures suivantes:

- Tournez l'antenne de la télé ou de la radio jusqu'à ce que les interférences disparaissent.
- Déplacez le XK-6 d'un côté ou de l'autre de la télé ou de la radio.
- Eloignez le XK-6 de la télé ou de la radio.
- Branchez le XK-6 sur une prise différente que la télé ou la radio.
- Installez une antenne sur le toit munie d'une connexion coaxiale entre elle et le poste de télévision.

Declaration of Conformity



Manufacturer:

E-MU Systems
1600 Green Hills Road
Scotts Valley, CA 95067-0015 USA

We hereby declare that the equipment listed herin conforms to the harmonized standards of the following European Commission Directives: 89/336/EEC and 72/23/EEC.

Trade Name: XK-6

Model Number: 9726

Under 89/336/EEC as amended by 92/31/EEC, and 93/68/EEC

In accordance with EN 55103-1:1996, Emission Environments E4

In accordance with EN 55103-2:1996, Immunity Environments E4

Test information is contained in a report by Atlas Compliance and Engineering, Inc.

Dated July 5, 2001

Report No.: 0126EMUx17_103

Under 73/23/EEC as amended by 93/68/EEC

In accordance with EN 60950 with amendments A1, A2, A3, A4, A11

This Declaration is made July 5, 2001



Setup

This section thoroughly describes how to set up your new XK-6 for use. Setup includes unpacking instructions, how to hook up the unit to your sound system and, most importantly, how to turn the thing on and off.

Unpacking

Carefully remove XK-6 from the packaging material. Take care to save the packing materials in case you need to transport the unit. Check to make sure all components are included and in good condition. If there are missing or damaged components, contact E-MU Systems immediately for replacement or repair.

The XK-6 box should include the following components:

- XK-6 unit
- Power cable
- This owners manual

Connection Instructions

Basic Setup

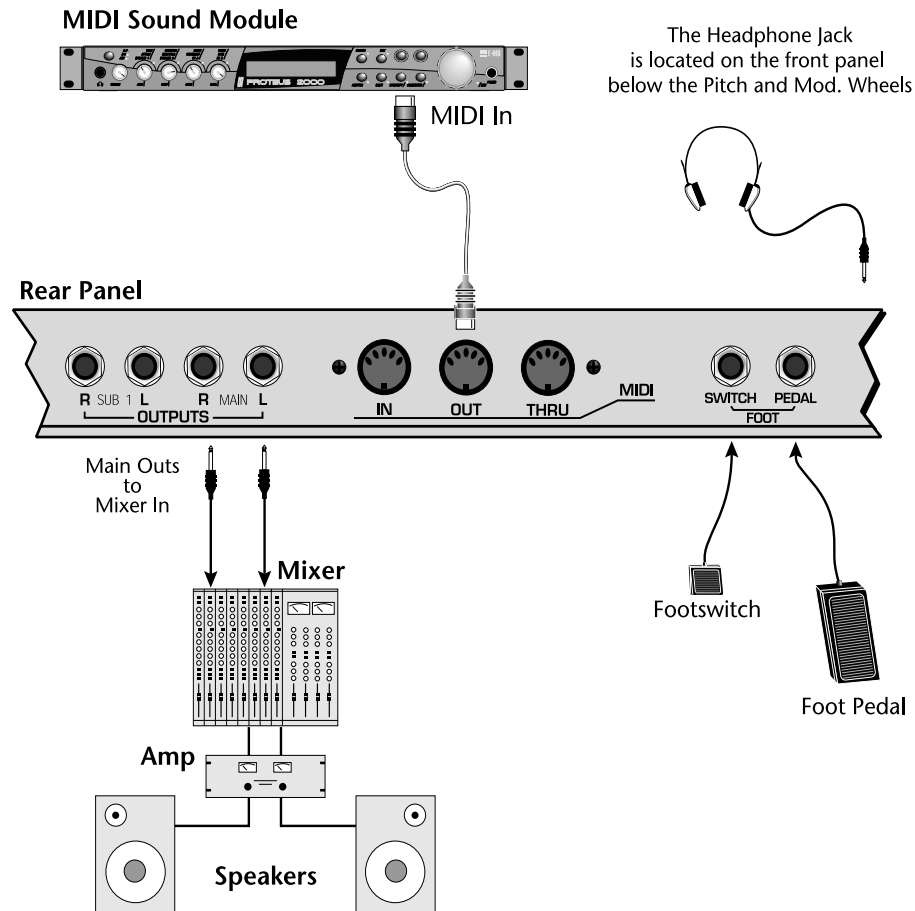

Power Switch & AC Receptacle

The AC power switch is located on the rear panel. There is no 110/220 Volt power selector switch since XK-6 utilizes an auto-switching power supply which accepts from 100V-250V, 50-60Hz.

MIDI Output

The XK-6 can control other MIDI instruments by connecting a MIDI cable between the MIDI out of XK-6 and the MIDI Input of the other instrument.

Outputs

In order to reproduce XK-6's wide dynamic range and frequency response, use a high quality amplification and speaker system and a stereo setup is highly desirable. The headphone output is the same as the Main output signal. The headphone jack is located on the left side of the front panel.

Footswitch & Footpedal

Connect a momentary footswitch and a Control Pedal for additional control. XK-6 auto-senses either normally-open or normally-closed switches. See page 15 for information about how the footpedal should be wired.

 The Right Main output jack carries a mono mix of the left and right channels when the Left Main plug is not plugged in.

The Left Main output jack is a stereo jack carrying both channels when the right output jack is empty.

Performance Setup

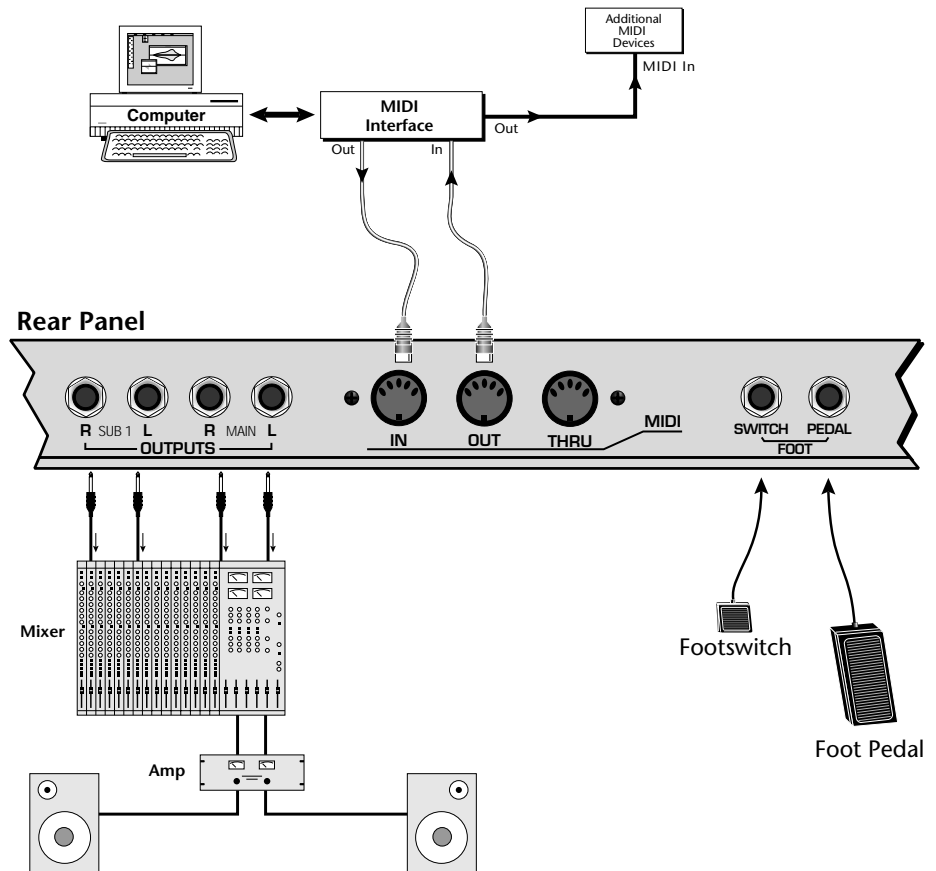

MIDI In/MIDI Out

XK-6 can be connected to a computer/sequencer via the MIDI In and MIDI Out ports. XK-6 to playback complex multitimbral sequences.

Audio Outputs

Two pairs of programmable stereo outputs (Main and Sub 1) are provided. The internal effects are available only on the Main outputs. Specific presets (or MIDI channels) can be routed to one of these stereo pairs in order to be processed further or mixed separately.

Footswitch & Footpedal

The footswitch input accepts either a normally-open or normally-closed momentary footswitch. The footpedal input can sense either 0-5 volts on the ring of a stereo jack or a pedal with the potentiometer wired as shown at left. The footswitch and Pedal inputs are programmable in the Controllers, Footswitch menu and the Preset Edit, PatchCord menu.

FootPedal Wiring

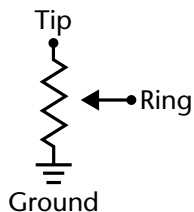
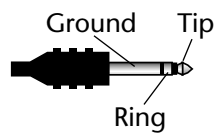

Studio Setup

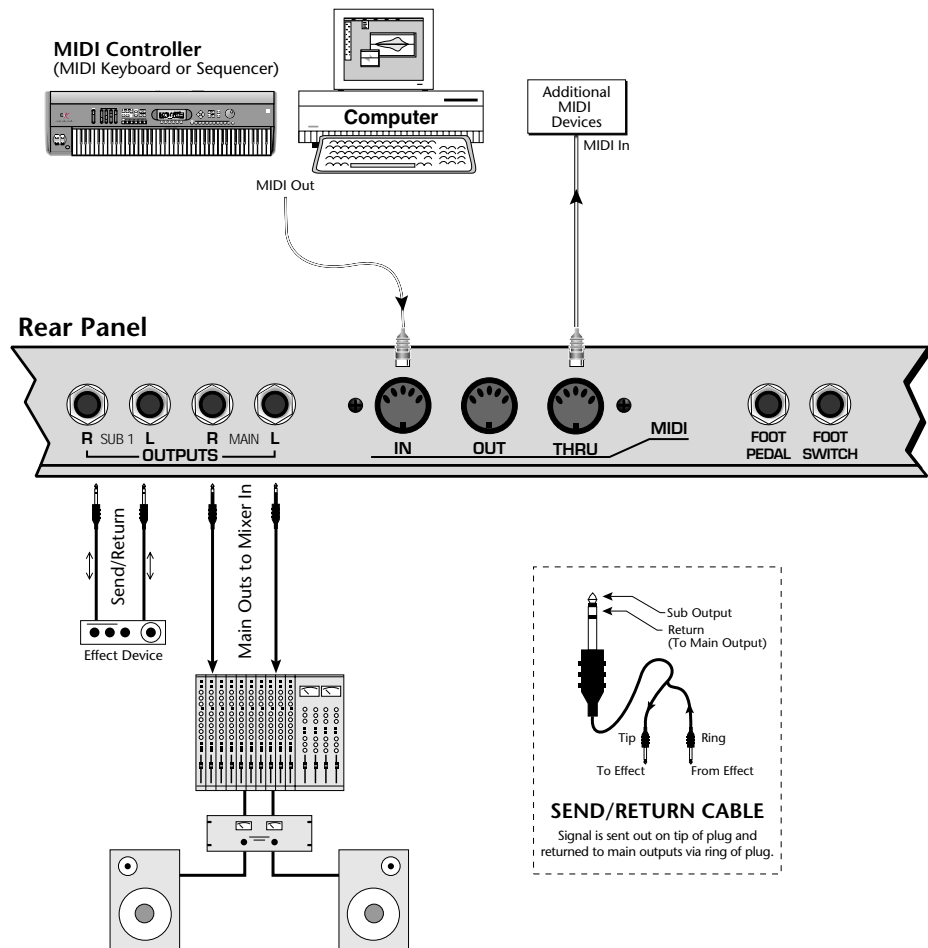

MIDI In

In this setup, XK-6 is additionally controlled by another MIDI keyboard.

MIDI Thru

MIDI Thru transmits an exact copy of the messages received at the MIDI In jack. It does NOT send keyboard or controller information generated from XK-6. (Use the MIDI Out port to send XK-6 data to another instrument.)

Audio Outputs

The Sub 1 output jacks are stereo jacks. The tip of each jack (accessed when a standard phone plug is inserted) connects to the left or right output of that group.

If you insert a stereo plug into one of the Sub Outputs, the ring of the plug serves as a signal Return which sums into the Main outputs.

Therefore, the Sub 1 jacks can serve as effect sends and returns in order to further process selected instruments and then return them to the main mix.

You can use the Sub 1 jacks as send/returns in order to further process selected XK-6 presets without using the effects bus on the mixing board. In a pinch, the effect returns can be used to sum additional instruments into the main outputs. It's like having an extra line mixer when you need more inputs!

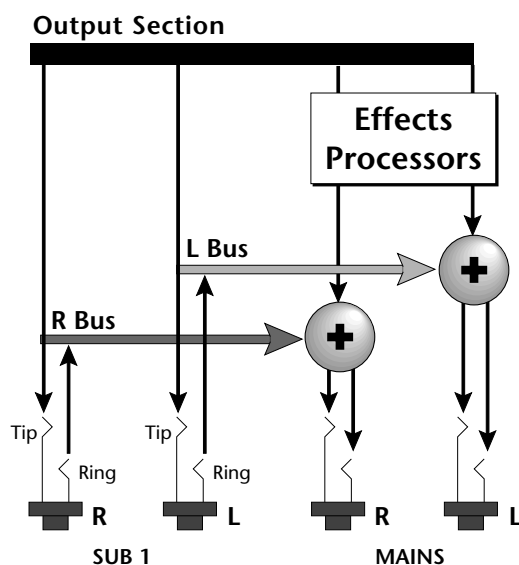

You can use the Sub 1 jacks as effect returns to the Main Outputs. Note that the Effects Processors are only routed to the Main Outputs.



Instant Gratification

Playing Demo Sequences

This section presents step-by-step instructions for the most fundamental operations to get you up and running as quickly as possible.

XK-6 has several factory demonstration sequences that let you hear what this incredible machine can do. The actual number of demo sequences depends on which ROM sounds sets are installed. You can play these demo sequences by accessing the Demo Sequence page.

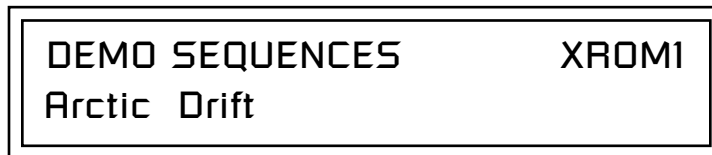

► To Play a Demo Sequence:

1. Press and hold the **Main** and **Mix** buttons at the same time to enter the Demo Sequence page. The screen shown above appears.
2. Select a sequence using the **data entry control**. The Enter LED will be flashing.
3. Press the **Enter** button to begin playing the selected sequence. The following screen appears.



4. Press the **Enter** button again to stop playing the sequence.
5. When a demo sequence plays to the end, the next demo will automatically begin playing. The screen will display the new demo name.
6. With the sequence stopped, **press any other button** to Exit demo sequence mode.

Auditioning Presets

 To audition presets with their programmed effects, switch to Omni or Poly mode (located in the MIDI menu).

The front panel audition button allows you to hear any preset in XK-6 without even playing a note! When the Audition button is pressed, the button's LED will illuminate and a short "Riff" (programmed as part of the preset) will play. The Riff is latched on and plays continuously until the button is pressed again. Presets can be changed while Audition is latched.

The top line of the Main screen changes to show the MIDI Bank Select controller values needed to select the preset being auditioned. This is an extremely handy feature when sequencing.

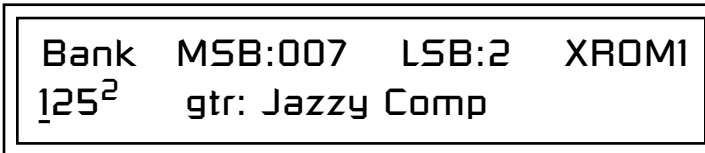

► To Audition a Preset:

1. Select a preset by turning the **data entry control** while the cursor is anywhere on the lower line of the main screen (shown below).
2. Select a preset by turning the **data entry control** while the cursor is anywhere on the lower line. The preset number field (shown above) is the normal position of the cursor and pressing the Enter button will return the cursor to this position.
3. Press the **Audition** button on the front panel. The Audition LED will illuminate and a short riff will play the selected preset.
4. Continue to select and audition presets.
5. Press the **Audition** button again to turn Audition mode off. The LED will extinguish.
6. Play the keyboard.
7. Be sure to check out the Pitch Wheel, controller knobs and Mod Wheel.

Selecting and Quick Editing Presets

The first thing you'll do with the XK-6 is select and play the factory provided presets. XK-6 comes standard with 8 banks containing 128 presets each. See "Main Screen" on page 37.

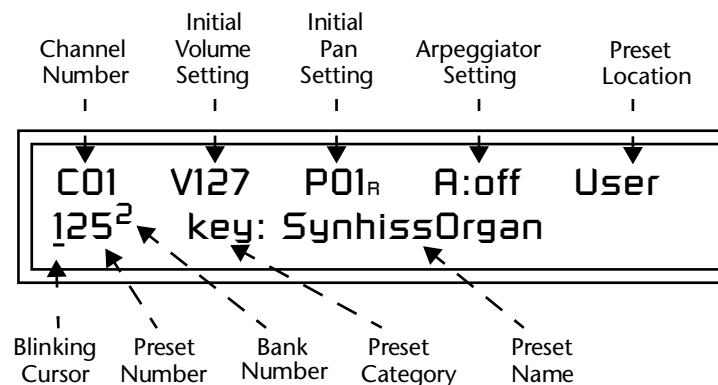

The first four banks are USER locations that can be overwritten and used to store your own presets. The presets that come stored in the USER presets are duplicated in banks 0-3 of the “XROM1” ROM bank, so feel free to overwrite them with your own presets. You won’t be losing anything.

The *ROM Card* identifier is shown in the top right of the display. The preset is identified in the bottom line of the main screen (the screen that appears when you press the Mode/View Preset button).

Each bank of 128 presets is identified by a superscripted *Bank Number* to the right of the preset number. The bank numbers reset to 0 at the start of each ROM card you have installed. So with the “XROM1” ROM installed, the USER banks will go from 0-3, then start over from 0-3 for the XK-6 ROM banks.

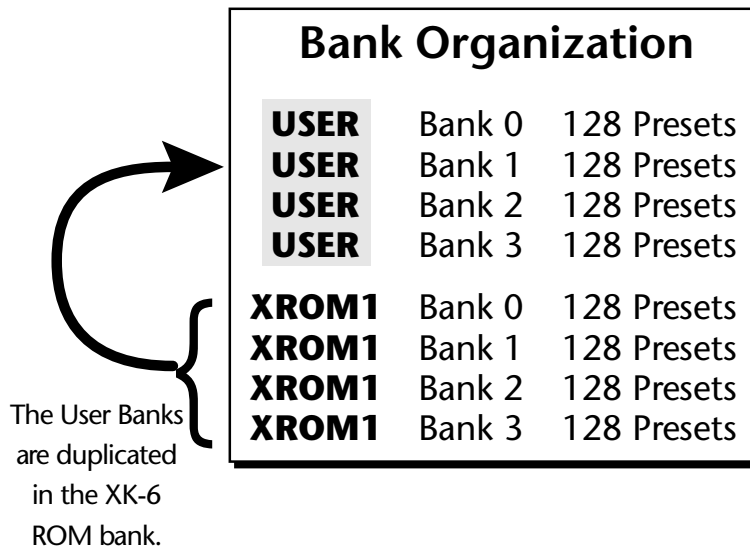

The four User Banks can hold 512 custom presets. Feel free to overwrite these since the factory user presets are duplicated in nonvolatile ROM.

To the right of the preset number and bank is the preset *Category* name followed by the *Preset Name*.

► **To Change the Preset:**

1. Select the main Preset Selection screen by turning off all the menu buttons below the LCD.
2. The cursor will be located under the first character in the Preset Number field. This is the “Home” position which is selected instantly when you press the Home/Enter button. Pressing either of the two cursor buttons repeatedly also gets you there.
3. Turn the **data entry control** knob on the front panel to select a new preset number. If you turn the knob slowly, the presets advance one number for each “click” of the knob. If you spin the knob quickly, the numbers advance much faster (more than one number per click).

You can select presets from the Preset Number, Bank Number, Preset Category or Preset Name fields.

Exploring Beats Mode

4. **Play the keyboard** (or press the Audition button) and listen to the sounds made by your XK-6!
5. **TRY OUT ANY OF THE CONTROLLER KNOBS** on the front panel and note how they change the sound of each preset! Don't worry about ruining the sound, the values are automatically reset as soon as you select a new preset. The four buttons labeled A-D, E-H, I-L, M-P allow the four controller knobs to control sixteen functions.

XK-6 contains a 16-track play-only sequencer that is optimized for live performance and groove creation. XK-6 contains dozens of special 16-part Beats Riffs. Beats Riffs are normally used in conjunction with a "bts:" preset containing the appropriate percussion mapping. Before you start exploring beats, make sure the XK-6 is properly set up.

► Beats Setup:

Set the Trigger Buttons to Beats Mode

1. Press the **Controllers** button on the front panel.
2. Turn the **data entry control** clockwise until you find the "TRIGGER BUTTONS FUNCTION" screen.
3. Set the lower line of the display to read, "Play Beats Parts".
4. Press the **Controllers** button on the front panel again to exit the menu.

Set the Trigger Buttons to be Triggers

5. Press the **Triggers** button in the Command Functions section of the front panel. OK, now you're ready to start playing Beats.

► Playing Beats:

Selecting Beats Presets

1. Press the **right cursor button twice** so that the cursor is located beneath the **Category** field.
2. Turn the **data entry control** until **bts:** is shown in the Category field.
3. Press the **right cursor button** so that the cursor is underneath the **Preset Name** field.
4. Now turning the **data entry control** selects **ONLY bts:** presets!

Play Beats

5. Press any of the sixteen front panel **Trigger Buttons**. Notice that each button brings in a specific part. The chart below shows which buttons control which part in **bts:** presets.



If you don't select a "bts:" preset, only the first trigger key will work.

Riffs marked "bts:" have 16 parts. Riffs without "bts:" have only 1 part.



The **Arp/Beats** LED flashes in time with the **Base Tempo**.

- Change the **Base Tempo** from the last screen in the **Controllers** menu.

Main Groove	Alt. Groove	Perc / Fills	Instr/Wild
1. Kick1	5. Kick2	9. Perc3/Fill1	13. Inst1/Wild1
2. Snare1	6. Snare2	10. Perc4/Fill2	14. Inst2/Wild2
3. Hihat1	7. Hihat2	11. Perc5/Fill3	15. Inst3/Wild3
4. Perc1	8. Perc2	12. Perc6/Inst.	16. Bass

- Also notice that the **Audition** LED comes on when **Beats** begin playing. **Beats** are simply multitrack **Audition** Riffs. Use the **Audition** button to turn **Beats** on and off.
- Try out a few different **bts:** presets.

Get Busy!

Two of the **Controller** knobs are programmed to control **Beats**. Check it out!

- Press the **M-P** button in the **Controllers** section. Its LED will light.
- Now turn the **Mod 1 knob** with a **Beats** Riff playing. **Mod 1** is controls the **Beats Busy** parameter which adds or subtracts parts from the **Beat**.
- Turn the **Mod 2 knob** with a **Beats** Riff playing. **Mod 2** is controls the **Beats Variation** parameter. **Beats Variation** changes which parts are playing without changing the number of parts. This makes it easy to try out different combinations of **Beat Parts**.

► To Play Beats on a different MIDI channel:

Beats can be assigned to a certain **MIDI** channel while you play the keyboard on another channel. (Make sure you have **Beats mode** set up correctly as described in “**Beats Setup**” on page 22.)

- Press the **Arp/Beats** button. The screen shown below appears.

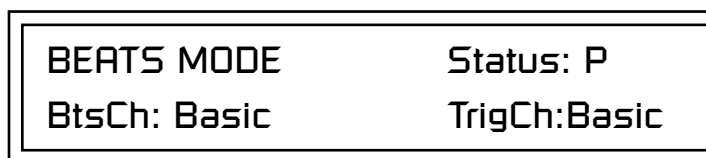

- Set the **Beats Channel (BtsCh)** to **01**.
- Select any **bts:** preset on channel 1 (main screen).
- Press any of the sixteen **Beats** buttons to start your **Beat** playing. (Do NOT start **Beats** by pressing the **Audition** button.)
- Press the + **Channel** button to the left of the **LCD** to select **channel 2**.
- Select a preset to jam along with the **Beat**.
- The **Trigger Keys** now play **Beats** and the other keys play the preset on channel 2.
- The **Audition** button can be used to turn the **Beat** off. (If you try to use it to turn **Beats** on while on channel 2, the **Riff** on channel 2 will play.)



Wrong FX? In **Omni** mode, the **FX** assigned to channel 2 will be used. In **Multi** mode, the **Master FX** settings will be used. See pages 88 & 98.

Exploring the Master Arpeggiator

XK-6's multi-channel Pattern Generator/Arpeggiator is one of the greatest features ever put in a synth. Let's explore the Master Arpeggiator.

► To Arpeggiate a Single Preset:

1. **Select a preset.** Note that the factory presets all have prefixes which describe the type of sound. For this investigation it might be best to choose a preset with the prefix "arp," for arpeggiator. These presets are optimized for use with the arpeggiator.
2. Set the Arp parameter in the main preset selection screen to "M" for Master Arpeggiator.

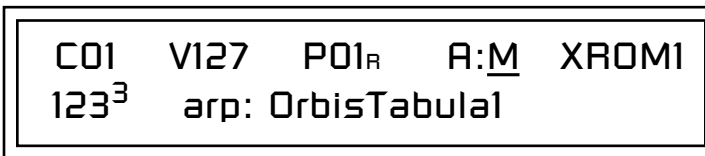

C01 V127 P01R A:M XROM1
123³ arp: OrbisTabula1

3. Press the **Arp/Beats** button in the Edit section of the front panel to access the master Arpeggiator menu, then use the **data entry control** to scroll to the screen shown below.



MASTER ARPEGGIATOR
Status on

4. Make sure the arpeggiator Status is "on." Play the keyboard to start arpeggiating.
5. Press either **cursor key** repeatedly to move the cursor below the Status field.
6. Turn the **data entry control** clockwise one click. The Mode screen appears.



MASTER ARPEGGIATOR
Mode pup

7. Use the **cursor keys** to move the cursor to the *Mode* field (up, down, up/down, forw asgn, backw asgn, forw/backw, random, pattern). Try out the different modes as you play the keyboard.
8. Move the cursor back to the lower left position and explore the other parameters. The *Note Value* parameter changes the rate of the arpeggios. By the way, note value is a divisor based on the Master Tempo. Try changing the tempo, but come right back.

9. Let's check out the pattern generator. Go back to the **Mode** screen and set the mode to "Pattern".
10. Now advance to the Pattern screen (shown below) and move the cursor to the **Pattern Number** field (the second field from the left).



 See the Arpeggiator
Chapter for detailed information
on creating Patterns.

11. Try the various patterns. There are 200 permanent factory patterns and 100 user locations to store the patterns you create. Each pattern can have up to 32 notes.

Multi-Channel Arpeggiator

XK-6 is totally amazing in its ability to run up to 16 arpeggiators at once! Even two or three patterns at once can create very complex sequences and dynamic landscapes of sound.

Here's one way to access this ultra-powerful feature. There is one arpeggiator for each MIDI channel. First you'll assign three of the Trigger Keys to MIDI channels 01-03. Next, you'll assign arpeggiator presets to these channels. Then you'll become addicted to this new way of making music.

Program the Trigger Keys

1. Press the **Controllers** button, then turn the data entry control until the screen shown below appears.



TRIGGER BUTTONS FUNCTION
Play Beats Parts

2. Move the **cursor** to the lower line and turn the data entry control to select "Play Note Events". This sets the Trigger Buttons to play note events instead of selecting Beats parts.
3. Move the **cursor** back to the top line and scroll to the screen shown below.

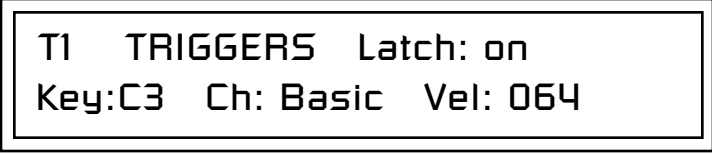

T1 TRIGGERS Latch: on
Key:C3 Ch: Basic Vel: 064

4. Move the **cursor** until it is underneath the **Latch** field and turn Latch mode On.
5. Move the **cursor** until it is underneath the **Channel** field (Ch) and set the **Channel to 01**.
6. Move the **cursor** until it is underneath the **Trigger** field (T1) and change the **Trigger to T2** (trigger button 2).
7. Turn **Latch On** for trigger button 2 and set the channel to **02**.
8. Change the **Trigger to T3** (trigger button 3).
9. Turn **Latch On** for trigger button 3 and set the channel to **03**.

Set up the Presets

10. Press the **Main** button (located beneath the Data Entry Control). The preset select screen appears.

C01	V127	P00	A:P	XROM1
026 ³	_arp:Holographik			

11. Move the cursor underneath the **Category** field (as shown above) and select the “**arp**” category.
12. Move the **cursor** underneath the preset name and select any “arp” preset for channel 1.
13. Press the “+” **Channel** select button (located to the left of the LCD), so that C02 is displayed.
14. Select any other “arp” preset for channel 2.
15. Select channel 03 and choose another arp preset.

Select Trigger Mode

16. Press the **Selector Button** in the upper left corner of the Command Functions section. Pressing this button will switch between Track Enable/Mute and Triggers mode. Select Triggers mode.

Play it!

17. Now press **Trigger Buttons 1, 2 and 3**. You should be hearing three arpeggiators playing at once.
18. **Change the arp preset** on the current MIDI channel. Since the cursor is located on the preset name, all your selections will be in the arp category.
19. Press the **Channel** button and change the arp presets for channels 1, 2 & 3. Since each factory preset has differently programmed arpeggiator settings, changing the preset not only changes the sound, but the arpeggiator as well.
20. You can also **play the keyboard**. You’ll be playing the preset currently showing in the display.
21. Adjusting the front panel **Controller Knobs** modifies the preset showing in the LCD.
22. Press the **M-P** button in the Controllers section to select the Arp control functions. Adjust the **Arp Velocity** and **Arp Gate Time**. Then change the **MIDI channel** and do it for another arp pattern.
23. Press the **Mix** button so that “VOLUMES” is selected. This screen lets you blend the volume of every arpeggiator preset.

 Sometimes a simple volume change will bring out hidden voices and patterns.

There’s lots more to the arpeggiators. To find out more, refer to the arpeggiator chapter beginning on page 43.



Multisetups save your entire XK-6 setup. Find out more on page 84.

Time to Save?

If you want to SAVE everything exactly as it is, continue on.

1. Press the **Multi** button (located directly under the Data Entry Control).
2. Rotate the **data entry control** until you get to the menu shown below.

```
MULTISETUP NAME
User Setup
```

3. Press the **right cursor** button to move to the lower line.
4. **Name your Multisetup** so you can find it later, then press **Enter**.
5. Scroll to the next screen using the **data entry control**.

```
SAVE SETUP TO
002 User Setup
```

6. Move the **cursor** to the lower line, select a location and press **Enter**.

Basic Operations

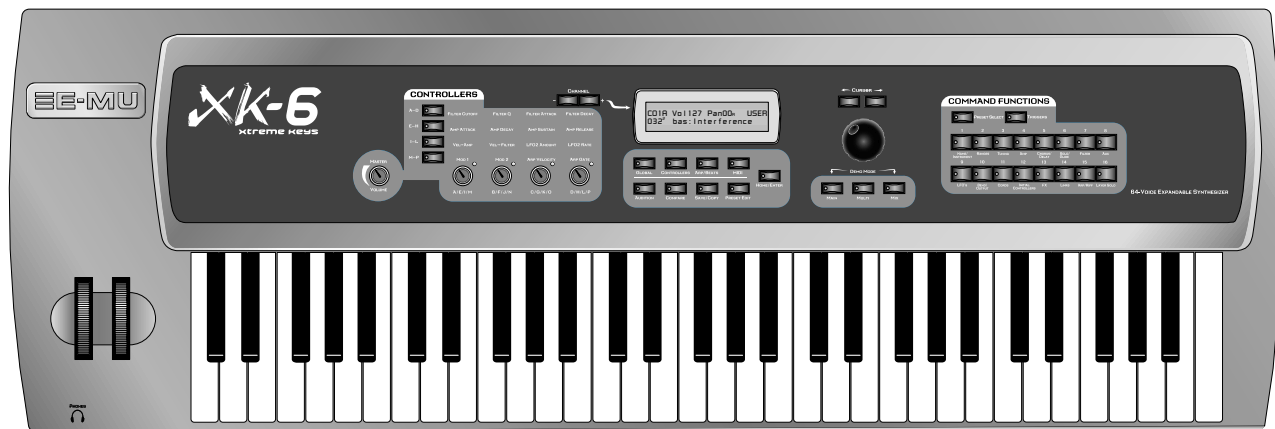

The XK-6 front panel contains an LCD screen, 38 buttons, and 4 real-time controller knobs. Functions are grouped logically and the controls are arranged for ease of use.

Power Switch

The power switch is located on the rear panel next to the AC power receptacle.

Volume Control

This control is the master volume control for all audio outputs. The Volume Control does not affect any editing or user interface operations.

The front panel volume control is a digital attenuator. For maximum dynamic range, turn this knob all the way up and control the volume from your mixer or amplifier.

Channel +/- Buttons



These very handy buttons, located to the left of the LCD, serve as a shortcut to increment or decrement the MIDI Channel (in Preset mode), Layer (in Preset Edit mode) or Step Numbers (in Arpeggiator Edit mode).

Data Entry Control

The data entry control is a stepped, variable control switch used to change parameter values. The wheel increments or decrements the current value one unit with each click. This control incorporates acceleration, which advances the value faster if the data entry control is turned quickly.

Cursor Buttons

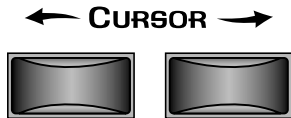

These buttons, located just above the Data Entry Control, move the cursor to the next parameter on the display. (The cursor is a little flashing line underneath one of the parameters in the display.) Press either cursor button until the cursor is underneath the desired parameter. The cursor buttons have an auto-repeat feature which advances the cursor when the button is held continuously.

The cursor can be moved bidirectionally using the data entry control while either cursor select button is held down (for example, press and hold the right cursor button and turn the data entry control).

Pitch & Mod Wheels

These two controls, located to the right of the keyboard, are performance expression controls. The left "Pitch Wheel", is spring-loaded and is normally used to bend the pitch up and down while playing. The center position is off. The pitch bend range is set using the "Pitch Bend Range" parameter in the Global menu (page 84).

The right "Mod Wheel" is programmed to add vibrato in most of the factory presets. Like all the controllers in XK-6, the Mod Wheel can be programmed to control any synthesizer parameter. See PatchCords on page 102 and page 157 for more information.

Edit Section

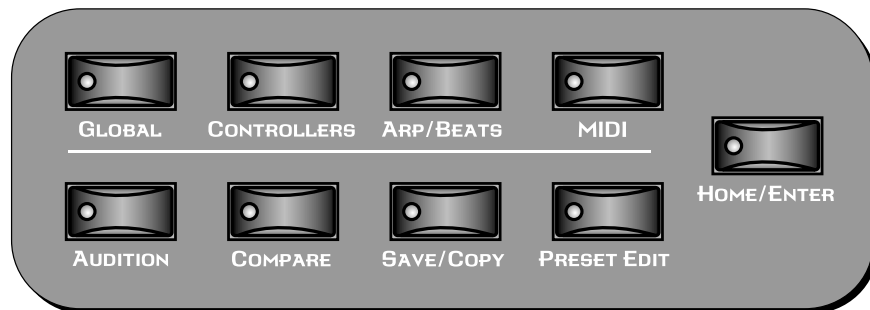

Global Button

The Global menu contains parameters that affect the entire machine. An illuminated LED in the button indicates that you are in the Global menu. For more information about the Global menu, see page 83

Controllers Button

The Controllers menu contains parameters that are related to the front panel controller knob and button triggers. An illuminated LED in the button indicates that you are in the Controllers menu. For more information about the Controllers menu, see page 71.

Arp/Beats Button

The Arpeggiator menu contains parameters that are related to Beats mode and the Master Arpeggiator. Beats is a 16-track play-only sequencer that is optimized for live performance and groove creation. An illuminated LED in the button indicates that you are in the Arp/Beats menu. For more information about the Arp/Beats menu, see page 43.

MIDI Button

The MIDI menu contains parameters that are MIDI related. An illuminated LED in the button indicates that you are in the MIDI menu. For more information about the MIDI menu, see page 93.

MIDI Panic Button

Pressing the MIDI and Home/Enter buttons simultaneously sends a MIDI “All Notes Off” and “All Sound Off” for all 16 MIDI channels. This immediately kills all sounding notes internally and over MIDI.

Audition Button

When the Audition button is pressed, the LED next to the button will illuminate and a short “Riff” (programmed as part of the preset) will play. The Riff is latched on and plays continuously until the button is pressed again. Presets can be changed while Audition is latched on. See “Bank Select Commands” on page 126 for more information on selecting banks via MIDI.

The top line of the Preset display changes to show the MIDI Bank Select controller values needed to select the preset being auditioned. This handy feature lets you know the exact Bank and Preset number.

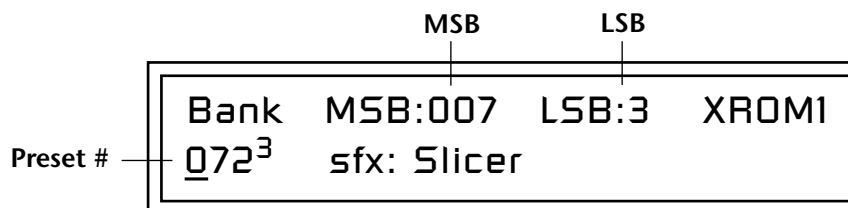

Compare Button

The Compare button allows you to toggle between an edited version of a preset and the original, unedited version. When a preset has been edited, the Save/Copy LED flashes. Press the Compare button, lighting its LED, to hear the unedited preset. Press the Compare button again to hear the edited preset. If edits are made to the preset while listening to the compared original version, compare mode is aborted and the compare LED goes off.

Save/Copy Button

The Save/Copy button is used to save changes to a preset, copy data between presets, randomize presets and to move other types of data. Selected groups of parameters, such as PatchCord settings, can be copied between Presets and/or between Layers using this menu. The menu is

context-sensitive and will start at the appropriate save screen. See Save/Copy on page 187 for more information.

The LED in the button illuminates to indicate that you are in the Save/Copy menu. The LED also illuminates when any preset parameter has been changed in the Preset Edit menu (or if the front panel knobs have been moved with Quick-Edit mode enabled).

Preset Edit Button

The Preset Edit menu allows you to create and edit presets. An illuminated LED in the button indicates that you are in Preset Edit mode. For more information about the Preset Edit menu, see page 129.

Home/Enter Button

The Home/Enter button is dual purpose. In general, this button acts as the “Home” button. For example, when in an Edit menu, this button snaps the cursor to the page name field of the current screen. When viewing the Preset Select screen, this button snaps the cursor to the preset number field. The flashing green LED of the Home/Enter button indicates that pressing the button will initiate a particular operation.

Real-time Controller Knobs

The Real-time Controller Knobs serve dual purposes. Knobs Preset Quick Edit (page 79) can be enabled to use the knobs for editing in the Preset Edit menu.

1. **Quick Edit** - Real-time control of internal synthesizer parameters and “Quick Editing” the initial settings of the real-time controllers
2. **Programmable Knobs** - Real-time control of MIDI continuous controllers on external synthesizers



Knob Functions



Quick Edit knob movements can be recorded into an external sequencer.

Quick Edit mode

The Real-time controller knobs provide direct control of the XK-6's synthesizer parameters when the Controller Function Select is set to Quick Edit.

There is an LED next to each of the control knobs which illuminates to indicate that the knob setting has been changed from the value programmed in the preset ("Knobs Preset Quick Edit" mode must be enabled in the Controllers menu). If the knob position is returned to the original setting, the LED is extinguished.

Initial controller values can be stored in every preset. When you move a knob with Quick-Edit enabled, the Initial Controller Value is updated with the knob's new value. The knob's LED lights indicating that the preset value has been changed. The MIDI A-P values are stored in the corresponding *Initial Controller Amount* parameter in the Preset Edit menu (see "Initial Controller Amount" on page 167). The Save/Copy button LED flashes to remind you that the preset has been edited. "Quick-Edits" made to a preset are lost if you select another preset before saving them.

The four rows of knobs always control the preset on the basic MIDI channel (the channel showing on the preset select screen), when the control switch is set to Quick Edit.

The labels (Filter Cutoff, Filter Q, Filter Attack, Filter Decay, etc.) printed on these rows show how the factory ROM presets are programmed to respond. *(The controls may not exactly conform to the front panel labels depending on the preset.)* You can change the way a preset responds to MIDI A-P messages from the Preset Edit menu (PatchCords). The knobs only generate a message when you move a knob to a new value. The current value jumps to the new value.

► To Quick-Edit a Preset:

1. Select **Quick Edit** mode using the Controller Function Select button.
2. Use the Control Knobs to change the sound of the current preset as desired.
3. Press the **Save/Copy** button. You may have to turn the data entry control so that the display reads, "Save PRESET to."
4. Press the right cursor button to select the bottom row.
5. **Optional:** Select a new preset location if you don't want to overwrite the current preset, or if the current preset is a ROM preset.
6. Press the **Enter** button to save the preset.

Screen View Buttons

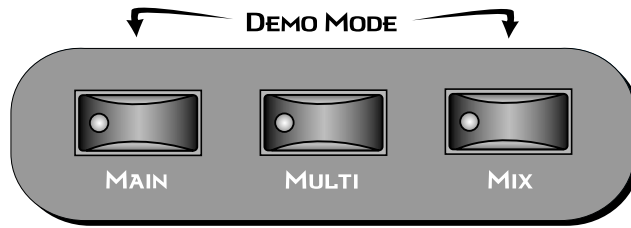

The Screen View buttons switch between three display modes.

Main

This button instantly switches the display to the Main Screen shown below. This screen is used for changing presets, changing MIDI channels and setting the volume and pan positions for each MIDI channel. See page 37 for more information.



Multi

This button switches the display to the Multisetup menu. A Multisetup is a group of parameters that you might associate with a particular performance setup or song. See page 41 for detailed information about Multisetups.



Mix Screen

This button switches the display to the Mix screens (volume & pan). The mix screens allow you view and adjust the volume and pan settings for all 16 channels. This is particularly useful when playing back a MIDI sequence. The volume and pan settings for all 16 channels are saved with the Multisetup (page 41).



Demo Mode



Pressing the Main and Mix buttons simultaneously calls up the Demo Sequence page. XK-6 has several factory demonstration sequences that let you hear what this incredible machine can do. The actual number of demo sequences depends on which ROM sounds sets are installed.



► To Play a Demo Sequence:

1. Press and hold the **Main** and **Mix** buttons at the same time to enter the Demo Sequence page. The screen shown above appears.
2. Select a sequence using the **data entry control**. The Enter LED will be flashing.
3. Press the **Enter** button to begin playing the selected sequence. The following screen appears.



4. Press the **Enter** button again to stop playing the sequence.
5. When a demo sequence plays to the end, the next demo will automatically begin playing. The screen will display the new demo name.
6. With the sequence stopped, **press any other button** to Exit demo sequence mode.

Command Functions

The Command Functions section serves multiple purposes which are listed below.

- **Beats Part enable/disable.** *See page 22.*
- **Assignable & latching note triggers.** *See page 76.*
- **Preset select keys.** *See page 77.*
- **External preset select keys.** *See page 78.*
- **Preset Edit menu jump keys.** *See below.*

Preset Selection

When the preset selection LED is lit, the command buttons can be used to quickly select sixteen of your favorite presets. In this mode, pressing one of the command buttons selects the preset you have assigned to the button. See page 77 for more information.

Trigger Mode

Select Triggers mode by pressing the mode select button so that the “Triggers” LED is illuminated. Now the 16 buttons work like keyboard notes. Each of the 16 buttons can be assigned to any MIDI note, on any MIDI Channel (01-16), with any velocity (0-127), and can be set to be latched or momentarily on. Latched note will hold until the button is pressed again. Latched notes will be indicated by the LEDs. Trigger keys are assigned from the Controllers menu. See page 76 for more information.

Preset Menu Jump Keys

Whenever you are in the Preset Edit menu, the sixteen command buttons function as “jump” buttons to the various screens in the Preset Edit menu. The jump location is labelled directly below each button.

Pressing a jump button instantly takes you to the first screen in the selected category. Pressing the button again takes you to the second screen in the category and so on. Repeated pressing will rotate you back to the first screen in the category.

Main Screen

The Main Screen is accessed by pressing the Main button located directly under the data entry control. From this screen you can examine or change the Preset, Volume, Pan Position and Preset Location for each of the 16 MIDI channels.

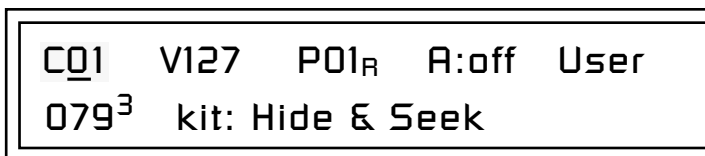

MIDI Channel Selection

► To Change the MIDI Channel:

1. Press the Main button to display the Main screen.
2. Press the Channel inc/dec buttons located to the left of the liquid crystal display to select channels 01 through 16. The preset, volume and pan settings for each channel will be displayed as you scroll through the channels.

The channel number shown in the main screen is the “Basic MIDI Channel” when in Omni or Poly modes.

Preset Selection

► To Change the Preset:

1. Press the **Main** button to display the Main screen.
2. Press either **cursor key** until the cursor is underneath the preset number. (The cursor is a little flashing line underneath one of the parameters in the display.) As you rotate the data entry control, the preset number and name changes.
3. The displayed preset is assigned to the displayed MIDI channel. Presets are arranged into banks of 128, as shown in the diagram at left.

Bank	Contents
0	– 128 RAM Presets
1	– 128 RAM Presets
2	– 128 RAM Presets
3	– 128 RAM Presets
ROM 1	0 – 128 ROM Presets
	1 – 128 ROM Presets
	2 – 128 ROM Presets
	⋮
	??
	Depending on ROM sets installed

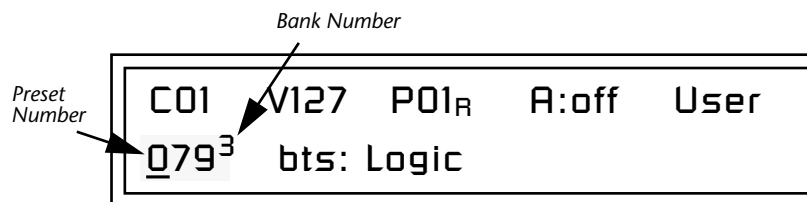

Using the screen above as an example, the superscripted number 2 in the second line of the display identifies the current bank number.

- Select banks independently of the of the preset number by locating the cursor on the Bank field and turning the data entry control.

MIDI BANK SELECT			
	MSB	LSB	
	cc00	cc32	
USER	00	00	Bank 0
USER	00	01	Bank 1
USER	00	02	Bank 2
USER	00	03	Bank 3
XROM1	07	00	Bank 0
XROM1	07	01	Bank 1
XROM1	07	02	Bank 2
XROM1	07	03	Bank 3

This chart shows the MSB and LSB numbers needed to select preset banks over MIDI. Select a bank, then send the program change number. Without a bank select command, presets are selected from within the current bank.

Channel Volume

Channel Volume sets the volume of the selected MIDI channel in relation to the other channels. This is the same parameter as MIDI volume control #7, and changes made over MIDI are shown in the display.

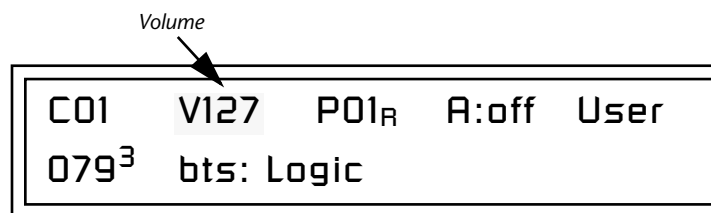

► To Change the Channel Volume:

1. Press the **Main** button to display the Preset Select screen.
2. Press either **cursor key** until the cursor is underneath the volume value.
3. Rotate the **data entry control** to select a volume level. The Channel Volume range is 000-127.

Channel Pan

Channel Pan sets the stereo position of the selected MIDI channel. This control operates like the balance control on your home stereo system. Channel Pan is the same parameter as MIDI pan controller #10, and changes made over MIDI are shown in the display.

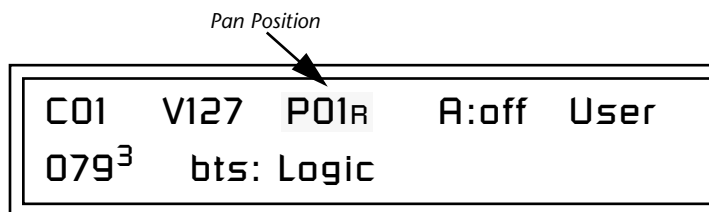

Note: Pan settings in the preset ADD algebraically with the Channel Pan setting. Therefore, if the pan setting in the preset were set to “63R,” moving the Channel Pan setting full left would return the sound to the center position.

► To Change the Channel Pan:

1. Press the **Main** button to display the Preset Select screen.
2. Press either **cursor key** until the cursor is underneath the pan field.
3. Rotate the data entry control to **select a pan value**. 64L indicates a hard left pan, 63R indicates a hard right pan. With a setting of “00,” the sound is centered in the stereo field.

Channel Arpeggiator

This function controls the arpeggiator for each MIDI channel. When the channel arpeggiator mode is set to Off, then there is no arpeggiation on that channel, regardless of what is set up in the Master Arpeggiator or preset. If the channel arpeggiator is On, the preset’s arpeggiator is used, regardless of whether or not it is turned on in the Preset Edit menu. This lets you turn on arpeggiation from the main screen.

If the mode is set to “P” (for preset), the preset’s arpeggiator settings and on/off status is used. If the mode is set to “M” (for master), the master arpeggiator settings and on/off status (located in the Arp menu) are used. See the “Arp/Beats Menu” on page 43 for more information.

► To Play the Arpeggiator (Quick Start):

1. From the **Main** screen, press either cursor key repeatedly until the cursor is underneath the **arpeggiator field (A:)**.
2. Rotate the data entry control to select “P” for preset.
3. Press either cursor key repeatedly until the cursor is underneath the **Preset Category** field and select “arp:” using the data entry control.
4. Press the right cursor button to move it to the **Preset Name** field.
5. **Play notes or chords** on the keyboard. Change presets as desired to audition the various patterns and presets.

Sound Navigator

Preset Category

Sound Navigator allows you to search through preset and instrument categories to find the type of sound you're looking for. Each preset and instrument has a name and a three letter preset category. You can create your own categories in order to group favorite presets. The preset category is assigned in the Preset Edit menu (Preset Name). Instrument categories are fixed.

When you want to find presets in a particular category, you simply change the category field in the Main screen, then move the cursor to the preset name field to scroll through all the presets in the selected category.

When the cursor is on the Preset Category field, turning the data entry control selects different preset categories. The Name Field will change to show the first preset in each category.

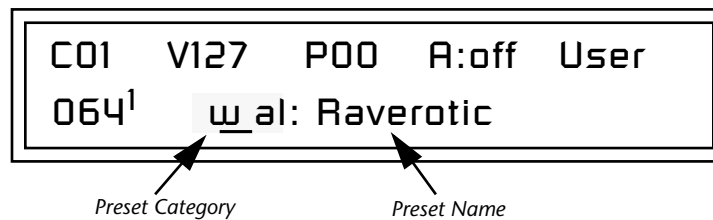

► To Change the Preset Category:

1. From the Main screen (shown above), press either cursor key repeatedly until the cursor is underneath the preset category field.
2. Rotate the data entry control to select one of the preset categories. Preset Categories are displayed in alphabetical order.

► To Select a Preset within a Category:

1. After selecting a category, move the cursor to the Preset Name field.
2. Rotate the data entry control to scroll through the presets in the selected category. Note that the preset numbers will no longer change sequentially.

Instrument Category

When the cursor is on the Instrument Category field (Preset Edit menu), turning the data entry control selects different instrument categories. The Name Field changes to show the first instrument in each category. Move the cursor back to the instrument name to choose other instruments in the selected category.



Multisetups

A Multisetup is a group of parameters that you might associate with a particular performance setup or song. It is like a “snapshot” of the current configuration of the XK-6. There are 64 setups numbered 0-63. All the Multisetups are user programmable except 63, the factory setup.

A Multisetup includes ALL the following parameters:

- Preset/Volume/Pan/Arp assignments for each of the 16 MIDI channels.
- Multisetup Name
- ALL Controllers menu parameters
- ALL Global Menu parameters, *except...*
User Key Tuning Tables
- ALL Arp Menu parameters, *except...*
User Arp Patterns
- ALL MIDI Menu parameters, *except...*
MIDI Program Change->Preset Map

When a Multisetup is selected, it overwrites the current Preset/Vol/Pan/Arp selections on all MIDI channels. It also overwrites the Controllers, Global, Arp, and MIDI menu parameters (with the exceptions noted above).

If you make changes to any of these menus, XK-6 will retain the changes, even if power is turned off. They are of course, overwritten when you restore a Multisetup.

Restoring Multisetups

XK-6 contains 64 Multisetup locations. These are all User locations except location 63, which is a factory defined Multisetup.

Multisetups can be restored using a MIDI Bank Select command. **Select: cc00 = 80, cc32 = 00, (dec)** then send a **Program Change** command corresponding to the Multisetup you wish to select.

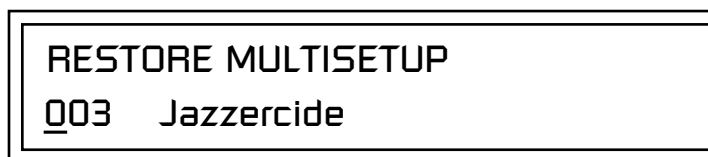

► To Restore (Select) a Multisetup:

1. Press the front panel Multisetup button (below the Data Entry Control).
2. Scroll to the Restore Multisetup screen using the data entry control. The menu page most recently selected since powering up XK-6 will be displayed. The cursor appears below the first character of the screen heading on line one.

Multisetup Name

3. Press either **cursor** button to move the cursor to the bottom line of the screen.
4. Now, use the **data entry control** to select a Multisetup. The Enter LED will be flashing.
5. Press the **Enter** button to load the selected Multisetup.

Multisetups can be named to make it easier to remember their purpose.

1. Scroll to the “Setup Name” screen (shown below) using the **data entry control**.

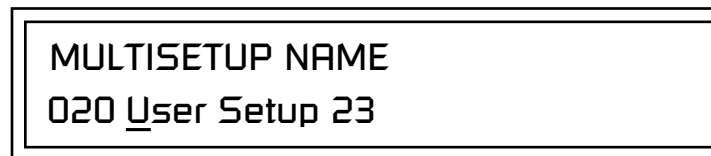

2. Press either **cursor** button to move the cursor to the bottom line of the screen.
3. Change the characters using the **data entry control**. Change the cursor position using the cursor buttons.
4. Press **Enter** or move the cursor to the top line when you’re finished naming the multisetup.

► To Save a Multisetup:

1. Set the Preset, Volume, Pan and Arp settings (in Main mode) for all channels. Set the Global, MIDI, and Controllers menu parameters the way you want them.
2. Press the **Multi** button, then scroll to the “Save Setup” screen (shown below) using the **data entry control**.

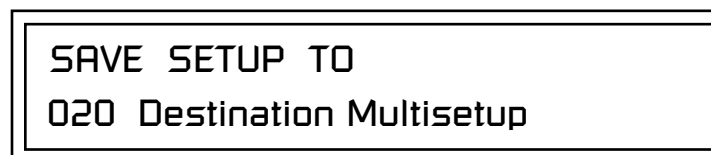

3. Press either **cursor** button to move the cursor to the bottom line of the screen.
4. Now, use the **data entry control** to select the destination location. The Enter LED will be flashing.
5. Press the **Enter** button to save the Multisetup.

Saving Multisetups

Arp/Beats Menu

XK-6's Beats mode allows you to trigger, latch and unlatch synced loops and grooves from separate keys on your keyboard. Simply select a beats preset and play the 16 trigger keys to bring specific *Parts* in and out. This is *Macro-Music!*

XK-6 can also run up to 16 simultaneously synced arpeggiators, each with a different preset sound. The arpeggiators can either play one of 7 chord arpeggios or can be set to play a pattern, which is a stored sequence of notes. Combined with Beats, the sheer number of musical permutations is staggering!

► To enable the Arpeggiator/Beats menu:

Press the Arp button, lighting the LED. The Arp screen displays the menu page most recently selected since powering up XK-6. The cursor appears below the first character of the screen heading on line one.

► To select a new screen:

Press the Home/Enter button or press the Cursor button repeatedly until the cursor is below the screen title heading on the top line of the display. Rotate the data entry control to select another screen.

► To modify a parameter:

Press either Cursor button repeatedly (or hold down the right cursor button while turning the data entry control) until the cursor is below the desired parameter value. Rotate the data entry control to change the value.

► To access a submenu:

The Master Arpeggiator screens have submenus which are accessed by pressing the cursor buttons to move the cursor to the lower left corner of the display. Select the submenu function using the data entry control.

► To save Arpeggiator parameters:

Press the front panel Multi button and scroll to "Save Setup To". Select a Setup number and press Enter. See "Saving Multisetups" on page 42.

► To return to the previously selected Mode/View screen:

Press the Arp/Beats button, turning off the LED.



Arp parameters are automatically saved to the current multisetup when you exit the menu, but you may wish to save to another location.

If another Multisetup is "Restored" any unsaved changes will be lost if you haven't saved the Multisetup.

Beats

XK-6 contains a 16-track play-only sequencer that is optimized for live performance and groove creation. XK-6 contains dozens of special 16-part Beats Riffs created by some of the best producers in the business. Beats Riffs are normally used in conjunction with a “bts:” preset containing the appropriate percussion mapping, but any preset can be selected and used.

The Beats channel is selected from the Beats enable screen in the Arp/Beats menu.

Here’s how it works. Each of the 16 parts is assigned to a trigger key on the selected Trigger MIDI channel. Each part is brought in or out by pressing that key. Keys can also be Latched (*press the key once to turn the part on, press it again to turn the part off*). Other control keys allow you to Mute All Parts, Clear All Parts, and Start & Stop the beat. The 16 parts are arranged in the following manner:

Main Groove	Alt. Groove	Perc / Fills	Instr/Wild
1. Kick1	5. Kick2	9. Perc3/Fill1	13. Inst1/Wild1
2. Snare1	6. Snare2	10. Perc4/Fill2	14. Inst2/Wild2
3. Hihat1	7. Hihat2	11. Perc5/Fill3	15. Inst3/Wild3
4. Perc1	8. Perc2	12. Perc6/Inst.	16. Bass

For each Beats Riff, you have 2 Grooves, 4 Fills which correspond to the four parts of the Main and Alternate groove, and 4 Instrument parts. By adding and removing parts, you control the complexity of the groove.

Each part can also be scaled by *Key Velocity*, allowing you to fade parts in and out (if velocity is routed to volume) as you play, or can be *Transposed* over a six octave range.

Each part can be assigned to any one of four *Groups*, which allow multiple parts to be triggered from a single key. You can only access Groups using the keyboard trigger keys. See the Factory Setup diagram on the next page.

Trigger layouts are saved with the Multisetup.



Beats (bts:) Riffs are special 16-part riffs made especially for use with Beats mode. A Riff without the bts: prefix only has Part 1 recorded.



By assigning Trigger Buttons (page 76) to the keyboard Beats Layout Keys, you can trigger Beats and MIDI notes using the Trigger buttons.

Factory Setup

Multisetup 63

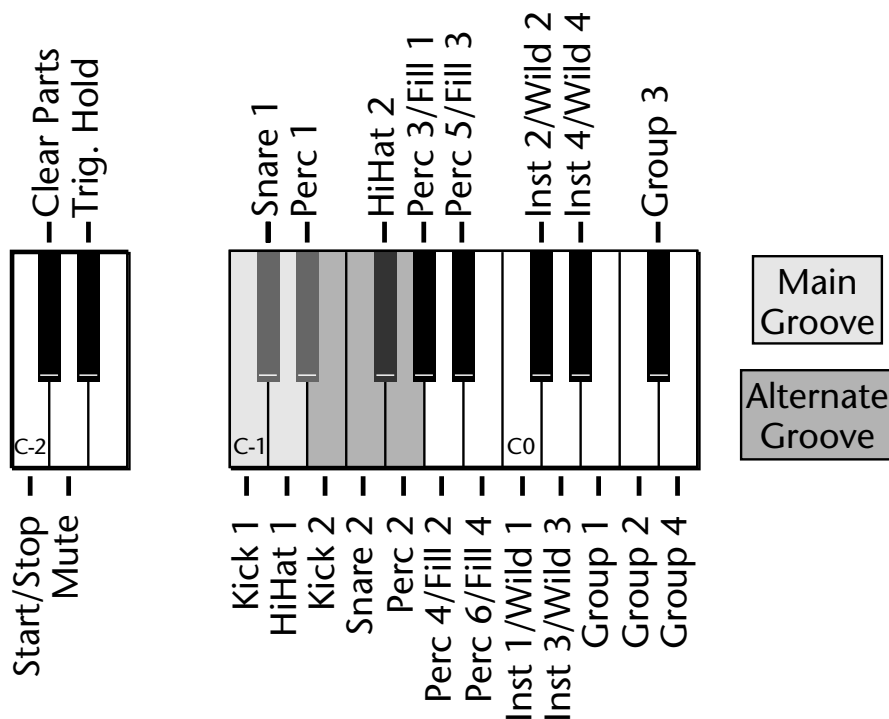

The chart above shows the Factory Multisetup assignment of each Part, the 4 Groups and the Control Keys. These assignments can be modified to suit your personal preference, then saved in one of the Multisetup locations.

 Starting Beats mode with the Start/Stop key allows you to start the sequencer rolling silently. Then you can bring Parts in and out using the “Busy” control.

 If Mute is set to 1-bar, the Part mutes for 1 bar then un-mutes.

- **Start/Stop Trigger** Starts the beat sequencer from the beginning of the sequence. When latched, pressing once starts and pressing again stops. When unlatched, the sequence runs as long as the key is held. Once the Beats sequencer is started, it continues to run even if no triggers are active. Start/Stop doesn't clear latched parts when it stops the sequencer. Any trigger played after stopping will not only start the sequencer and play that trigger's part, but also play all previously latched parts.
- **Clear Parts** Clears any enabled parts. This control provides a quick and easy way to shut off all latched Parts. Latch mode has no effect on this key.
- **Mute** Mutes all Parts while held, but the Beats sequencer continues running.
- **Trig Hold** When this key is held, all other Trigger Keys behave as if they were in Latch mode.

Beats Mode

The Beats sequencer plays as long as any Beats triggers are active. Beats Riffs can also be **Restarted** using a MIDI Song Start command even if the Beats channel is not currently selected. The Audition LED illuminates whenever the Beats sequencer is running (even if no Parts are playing).

Pressing the Audition button or starting a Demo causes the Beats sequencer to stop. Pressing the Audition button plays selected Parts on “bts:” presets.

All Arp/Beats parameters are saved with the Multisetup. (See “Multi-setups” on page 41 for more information.)

This screen turns Beats mode on and has several other features which allow flexible control over Beats mode. There are several status modes that determine when Beats will be turned on and which Riff will be used.

Beats and BEAT Triggers can be set to different MIDI channels. This allows you to perform on two MIDI channels at once with a keyboard that only transmits on a single MIDI channel.

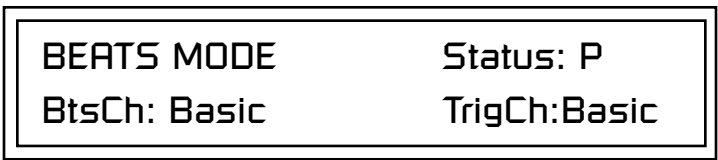

 *The Basic Channel is the MIDI channel currently displayed in the Main Screen.*

Status

- **Off** Beats mode off.
- **On** Beats mode on. The Riff assigned in the preset is used.
- **P** Beats mode is turned on *ONLY* if the Riff assigned in the preset is a “bts:” riff. The Riff assigned in the preset is used. (*Default setting*)
- **M.** Beats mode on. The Master Riff is used (Arp/Beats menu).

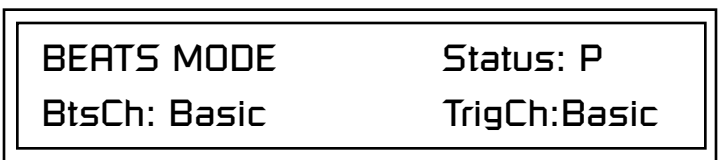

Beats Channel (BtsCh)

- **01-16** Selects the MIDI channel on which Beats play.
- **Basic** Beats play on the MIDI channel displayed in the Main Screen.

Trigger Channel (TrigCh)

- **01-16** Selects the MIDI channel on which Trigger Keys will be active.
- **Basic** Sets the Trigger Keys to the MIDI channel displayed on the Main Screen.

► Beats Setup:

Set the Trigger Buttons to Beats Mode

1. Press the **Controllers** button on the front panel.
2. Turn the **data entry control** clockwise until you find the “TRIGGER BUTTONS FUNCTION” screen.
3. Set the lower line of the display to read, “Play Beats Parts”.
4. Press the **Controllers** button on the front panel again to exit the menu.

Set the Trigger Buttons to be Triggers

5. Press the **Triggers** button in the Command Functions section of the front panel. OK, now you’re ready to start playing Beats.

► Playing Beats:

Selecting Beats Presets

1. Press the **right cursor button** twice so that the cursor is located beneath the **Category** field.
2. Turn the **data entry control** until **bts:** is shown in the Category field.
3. Press the **right cursor button** so that the cursor is underneath the **Preset Name** field.
4. Now turning the **data entry control** selects ONLY **bts:** presets!

Play Beats

5. Press any of the sixteen front panel **Trigger Buttons**. Notice that each button brings in a specific part. The chart below shows which buttons control which part in **bts:** presets.

Main Groove	Alt. Groove	Perc / Fills	Instr/Wild
1. Kick1	5. Kick2	9. Perc3/Fill1	13. Inst1/Wild1
2. Snare1	6. Snare2	10. Perc4/Fill2	14. Inst2/Wild2
3. Hihat1	7. Hihat2	11. Perc5/Fill3	15. Inst3/Wild3
4. Perc1	8. Perc2	12. Perc6/Inst.	16. Bass

6. Also notice that the Audition LED comes on when Beats begin playing. Beats are simply multitrack Audition Riffs. You can use the **Audition** button to turn Beats on and off.
7. Try out a few different **bts:** presets.

Get Busy!

Two of the Controller knobs are programmed to control Beats. Check it out!

8. Press the **M-P** button in the **Controllers** section. Its LED will light.



If you don't select a "bts:" preset, only the first trigger key will work.

Riffs marked "bts:" have 16 parts. Riffs without "bts:" have only 1 part.

9. Now turn the **Mod 1 knob** with a Beats Riff playing. Mod 1 is controls the *Beats Busy* parameter which adds or subtracts parts from the Beat.
10. Turn the **Mod 2 knob** with a Beats Riff playing. Mod 2 is controls the *Beats Variation* parameter. Beats Variation changes which parts are playing without changing the number of parts. This makes it easy to try out different combinations of Beat Parts.

► **To Play Beats on a different MIDI channel:**

Beats can be assigned to a certain MIDI channel while you play the keyboard on another channel. *(Make sure you have Beats mode set up correctly as described in "Beats Setup" on page 47.)*

1. Press the **Arp/Beats** button. The screen shown below appears.

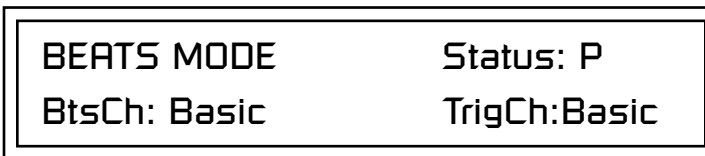

2. Set the Beats Channel (BtsCh) to **01**.
3. Select any **bts:** preset on channel 1 *(main screen)*.
4. Press any of the sixteen **Beats buttons** to start your Beat playing. *(Do NOT start Beats by pressing the Audition button.)*
5. Press the + **Channel** button to the left of the LCD to select **channel 2**.
6. Select a preset to jam along with the Beat.
7. The Trigger Keys now play Beats and the other keys play the preset on channel 2.
8. The Audition button can be used to turn the Beat off. *(If you try to use it to turn Beats on while on channel 2, the Riff on channel 2 will play.)*

 **Wrong FX?** In Omni mode, the FX assigned to channel 2 will be used. In Multi mode, the Master FX settings will be used. See pages 88 & 98.

Beats Controllers

Beats can be controlled using the front panel real-time controllers or external MIDI continuous controllers. **Controllers are patched to Beats via the Preset PatchCords located in the Edit menu.** The following Preset PatchCord destinations control Beats.

Beat Velocity Group 1-4 (BtsVelG1 -> BtsVelG4)

Parts assigned to one of the four Beats groups can have their velocity scaled by the controller input. Since most “bts” presets have velocity controlling volume, this control can be used to mix the relative levels of the Groups.

Beats velocity works as a percent *addition*. An input value of 0 (or no Cord) means change the velocity by 0%. A full scale modulation setting of 100% in the PatchCord adds 100% to the velocity value $100\% + 100\% = 200\%$. A PatchCord setting of -100% *subtracts* 100% from the velocity (making it 0). Beat velocity scalings are reset with a preset change.

Beat Xpose Group 1-4 (BtsXpsG1 -> BtsXpsG4)

Parts assigned to one of the four Beats groups are transposed by the controller input. Transpose works by shifting the keyboard position and not by changing the tuning of individual notes. Therefore, on a Beats presets (bts), where different instruments are assigned to each key, Transpose has the effect of changing the instrument used by a particular part. This control **ADDS** to the Part Transpose set in the Beats Transpose screen (page 53). Beat transpose offsets are reset with a preset change.

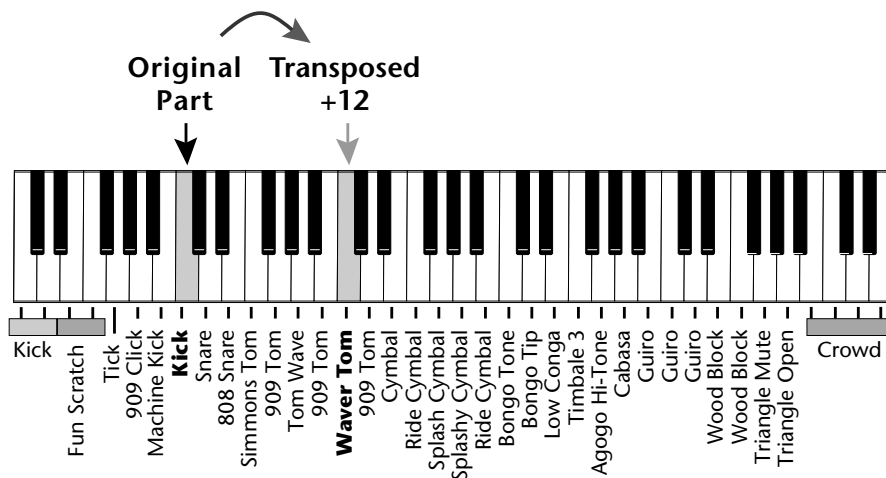



Beat Busy (BtsBusy)

This destination determines which parts are enabled. Beat Busy will accept either positive or negative values.

- **Positive values Add parts to whatever parts are triggered**
- **Negative values Remove parts that are triggered.**

 The Mod 1 controller knob is assigned to Beats Busy.

 A PatchCord amount of 50% is enough to drive Beat Busy to the maximum setting.

 **Hot Tip!**
The Bidirectional Mod Wheel:
Set Mod Wheel to BtsBusy with a Cord amount of +100, then add a DC bias to BtsBusy with a Cord amount of -50. Wheel now adds or subtracts "Busyness".

 **Cool Tip!** Connecting Key Pressure to Beat Busy at 50% increases BEAT complexity the harder you press.

 The Mod 2 controller knob is assigned to Beats Variation.

Suppose the pitch wheel (which can output both positive and negative values) were connected to Beat Busy and four Key Triggers are down. As the pitch wheel is moved from center to fully up, the remaining parts will be enabled until the pitch wheel is fully up and all parts are playing. Moving the pitch wheel from center to fully down, the four triggered parts are sequentially removed until at the most negative position of the wheel, no parts are playing.

The Busy control acts on the Beats condition whenever the control is changed. Playing more triggers without changing the Busy control simply adds them until the Busy control is changed again, at which point it will possibly add or subtract parts as needed.

The interaction between the Busy control, Triggers, Part Velocity and Group Velocity can get complicated, but works according to this rule:

WHICHEVER CONTROL WAS LAST CHANGED TAKES OVER

When interacting with the Group Velocity scale control, the Busy control ignores group velocity even when it is set to zero, enabling and disabling parts as necessary. If the Group Velocity is changed *after* the Busy control, it takes control, scaling parts as it deems necessary.

The Busy control *does* take the Part velocity into account when adding and subtracting parts. If a part has a velocity of 0%, it is removed from the list of parts that the Busy control adds or subtracts. Therefore, you can use the Part Velocity control to remove parts you don't want to hear.

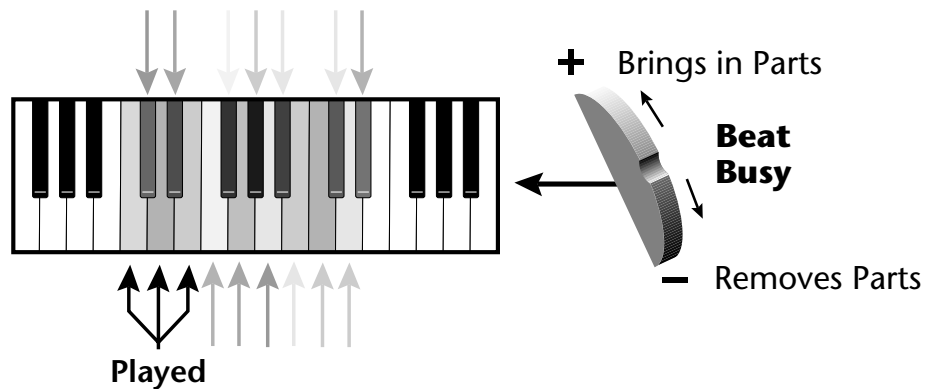

Positive controller values bring in new Parts and negative controller values remove Parts that are latched or held. In this example, the Pitch Wheel is connected to Beat Busy since it outputs negative as well as positive values.

Beat Variation (BtsVari)

Beat Variation varies which Parts are brought in and out using the Beat Busy control. Increasing this control mixes up the order in which Parts are brought in and out, thus providing even more permutations to the Beat.

Beats Keys Layout



Save your Beats Keys Layouts and all other Arp/Beats parameters using "Save Setup" function in the Multisetup menu.

This screen assigns the Beats triggers to keyboard notes on the Beats channel. For each Part, Group and Control Key you can select the following options:

- **Key** Selects which keyboard key triggers the Part
- **Latch** The first key press turns the Part on, the next turns it off.
- **Unlatch** The Part plays only while the key is held.
- **1-bar** The Part plays for one bar then stops.

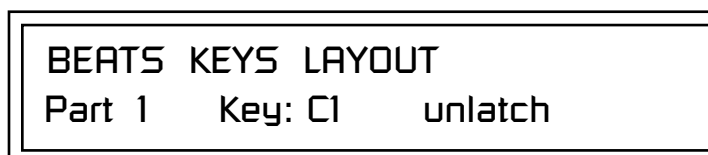

1-Bar Trigger Option

The 1-bar option requires a bit of explanation. When a trigger key is pressed before the last beat of the measure, the part will continue playing until the end of the measure. If the Trigger Key is pressed after the last beat of the measure, the part waits until the next measure before playing. Then it plays for the entire measure and stops. The time signature and the measure bounds are determined by the particular Beats Riff you are playing.

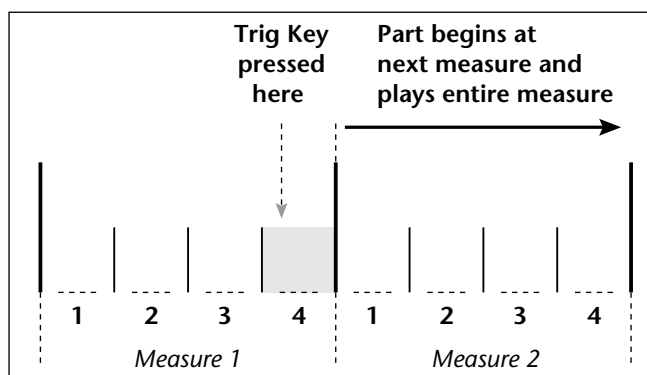
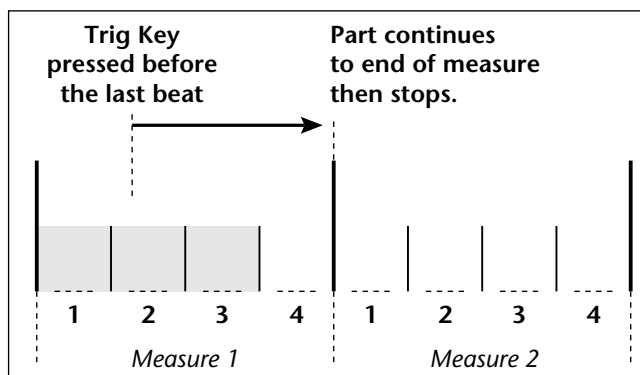

Beats Keys Offset

This function slides the Beats Trigger keys (*assigned in the previous screen*) up and down the keyboard. This makes it easy to change the keyboard location of the trigger keys without having to re-assign each key. A positive offset moves the group of triggers up the keyboard by the designated number of keys. Negative offsets move the trigger group lower on the keyboard.

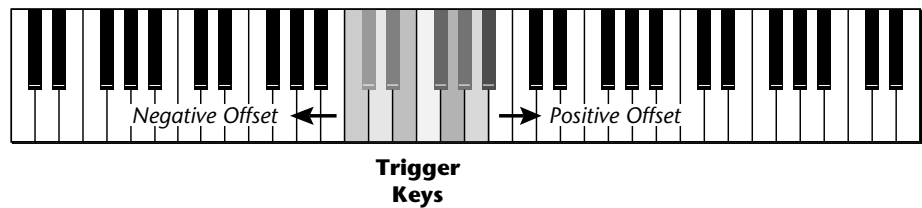

Beats Keys Offset slides the entire group of beats triggers up or down the keyboard.

Beats Part Velocity

Each note of a Beats Riff can have its recorded velocity scaled by a value (from 0 to 120%) of the recorded velocity or the actual played velocity of the trigger key can be used (trigger vel). For example, if a note's velocity is 80, scaling by 110% will increase the note's velocity to 88. This feature allows you to control the mix of the different parts in advance or "on-the-fly" as you play. If a part's velocity is set to 0%, that part will be removed from the mix.

Select Part

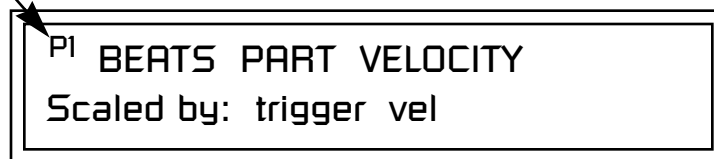

► To Set the Velocity for each Part:

1. Press the left cursor button to move the cursor under the Part field.
2. Select the Part number using the Data Entry Control. Parts 1-16 can be selected. (*All parts, shown as an "A", can be edited at once if "Edit All Layers" is enabled in the Master menu.*)
3. Move the cursor to the bottom line using the cursor keys and adjust the Velocity Scaling percentage using the Data Entry Control.
4. Repeat steps 1 through 3 for all the Parts you wish to adjust.
5. Press the Enter/Home button or use the cursor keys to move the cursor back to the screen heading.

Beats Part Transpose

Each Part of a Beat Riff can be transposed up to 36 semitones up or down. Transpose works by shifting the keyboard position and not by changing the tuning of individual notes. Therefore, on a Beats preset (bts:), where different instruments are assigned to each key, **Transpose has the effect of changing the instrument used by a particular part.** On a preset where a single sound covers the entire keyboard, Transpose will actually transpose the sound.

Select Part

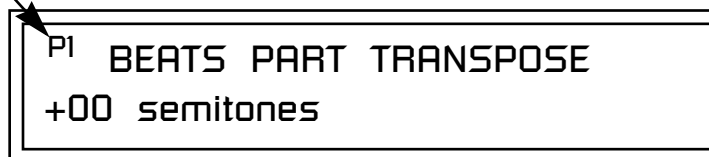

► To set the Transposition for each Part:

1. Press the left cursor button to move the cursor under the Part field.
2. Select the Part number using the Data Entry Control. Parts 1-16 can be selected. (All parts, shown as an "A", can be edited at once if "Edit All Layers" is enabled in the Master menu.)
3. Move the cursor to the bottom line using the cursor keys and adjust the Transposition in semitones using the Data Entry Control.
4. Repeat steps 1 through 3 for all the Parts you wish to adjust.
5. Press the Enter/Home button or use the cursor keys to move the cursor back to the screen heading.

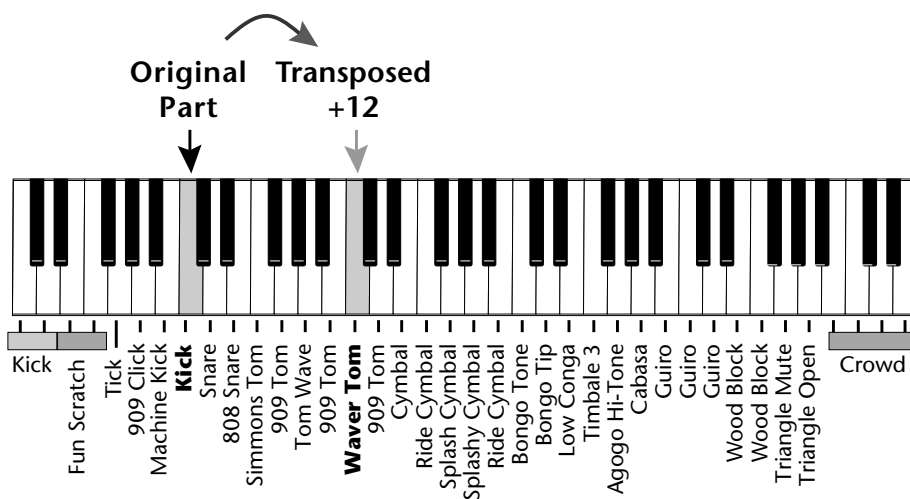

Beats Part Group

This screen is where you assign Parts to one of the four Groups. By grouping, you can play multiple parts with a single key. A part can be in one and only one group, or in no groups.

Select Part

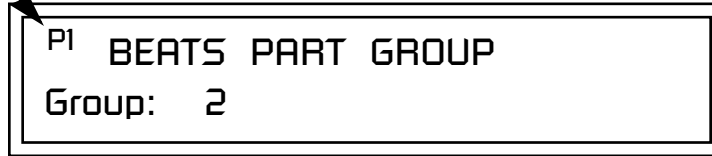

All Parts assigned to a Group will stop playing when the Group key is triggered, then untriggered even if the individual Parts in the Group are latched.

► To Assign a Part to a Group:

1. Press the left cursor button to move the cursor under the Part field.
2. Select the Part number using the Data Entry Control. Parts 1-16 can be selected. (*All parts, shown as an "A", can be edited at once if "Edit All Layers" is enabled in the Master menu.*)
3. Move the cursor to the bottom line using the cursor keys and select the Group (1-4 or none) using the Data Entry Control.
4. Repeat steps 1 through 3 for all the Parts you wish to assign.
5. Press the Enter/Home button or use the cursor keys to move the cursor back to the screen heading.

Master Riff

The Master Riff is selected from this screen. The Master Riff is used when Master (M) is selected for Beats in Beats mode enable screen.

► To Assign the Master Riff:

1. Use the cursor buttons to move the cursor to the lower line of the display.
2. Select the desired Riff using the Data Entry Control. (Beats Riffs are identified by the **bts:** prefix.)
3. If there is more than one ROM in XK-6 you can select Riffs from either ROM set. Move the cursor under the ROM ID and select using the Data Entry Control.
4. Press the Enter/Home button or use the cursor keys to move the cursor back to the screen heading.

Riff Tempo

This setting determines whether **Riff Tempo** (the tempo stored with each Riff) or the **Current Tempo** (the Base Tempo from the Master Clock) will be used for Beats.

To control the Riff Tempo from MIDI clock, set Riff Tempo to “use current tempo” and Base Tempo to “use MIDI”.

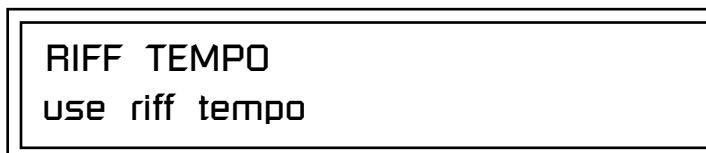

► To Set the Riff Tempo Mode:

1. Use the cursor buttons to move the cursor to the lower line of the display.
2. Select “use riff tempo” or “use current tempo” using the Data Entry Control.
3. Press the Enter/Home button or use the cursor keys to move the cursor back to the screen heading.

Riff Controllers

Riffs contain real-time control information. This function allows you to turn these controllers On or Off for the Riffs. This control affects Audition Riffs as well as Beats Riffs.



► To Turn Riff Controllers On or Off:

1. Use the cursor buttons to move the cursor to the lower line of the display.
2. Select “use riff controllers” or “ignore riff controllers” using the Data Entry Control.
3. Press the Enter/Home button or use the cursor keys to move the cursor back to the screen heading.

MIDI Song Start

This function enables or disables MIDI Song Start for the Arpeggiator and Riffs. The MIDI Song Start option restarts the arpeggiator and/or Riff (BEAT) to the beginning when a MIDI Song Start command is received. This is useful for synchronizing arpeggios and Beats when recording into, or playing along with a sequencer. You can choose to resync: Arp, Riff, both Arp and Riff, or disable MIDI Song Start.

MIDI SONG START
resyncs arps & riffs

Arp/Riff MIDI Out

This parameter selects whether or not the Arpeggiator and/or Riff (Beats) note data is sent to the MIDI out port. This feature lets you use XK-6 as an arpeggiator or sequencer for your other MIDI instruments. It also lets you record the arpeggios and Riffs into a MIDI sequencer. You can choose to transmit: Arpeggiator data, Riff data, both Arp and Riff data, or nothing.

ARP/RIFF MIDI OUT
don't transmit

Arpeggiators

An arpeggiator moves a pattern of notes sequentially over a range of the keyboard. XK-6 has the unique ability to play a different arpeggiator on each MIDI channel!

Arpeggiator settings can be defined as part of the preset (using the Arp parameters in the Preset Edit menu), or globally in the Arpeggiator menu. The preset and master arpeggiators have the same parameters which we define in this chapter.

The Arp field in the main screen defines which arpeggiator settings will be used. "M" uses the master Arpeggiator settings and on/off status (as defined in the Arpeggiator menu). "P" uses the preset's arpeggiator settings and on/off status (as defined in the Edit menu). Choosing "On" uses the preset's arpeggiator settings regardless of whether or not it is turned on in the Edit menu and Off turns off the arpeggiator regardless of the settings and status specified in either menu.



SAVE your Arp setups
and name them using the "Save Setup To" function located in the **Multi** menu. See "Saving Multisetups" on page 42.

Arp Settings in the
Preset are Used

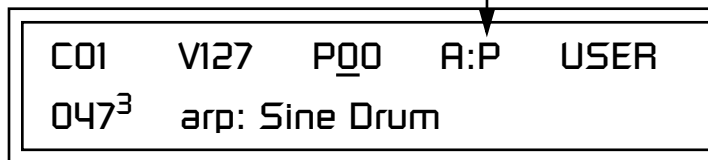

All arpeggiators share XK-6's master clock and its current setting. The master clock can be XK-6's internal clock or an external MIDI clock (page 82). Although the arpeggiators use the master clock setting, the tempo divisor can be unique for each arpeggiator setup.

Arpeggiator modes include up, up/down, forward assign, backward assign, forward/backward assign and random as well as play *Patterns*. Patterns are pre-recorded sequences of notes and rests. All key-on notes play the pattern. For example, if you play a chord, all the notes in the chord play the pattern in harmony. XK-6 contains 200 factory patterns and 100 user definable patterns.

Arp Controllers

The Arpeggiators can be controlled using the front panel real-time controllers or external MIDI continuous controllers. Controllers are patched to Arps via the Preset PatchCords located in the Preset Edit menu. See “Preset Patchcords” on page 165. The following Preset PatchCord destinations control the Arpeggiators.

Arpeggiator Resolution (ArpRes)

This control changes the Arpeggiator Note Value, which defines the length of the notes when playing arpeggiated chords. It *adds* to the note value set in the Arpeggiator Note Value screen. See “Note Value” on page 60.

Arpeggiator Extension (ArpExt)

This control changes the Arpeggiator Extension Count. It *adds* to the extension count programmed in the Arpeggiator Note Value screen. See “Extension Count” on page 62.

Arpeggiator Velocity (ArpVel)

This control changes the Arpeggiator Velocity Value. It *scales* the velocity value set in the Arpeggiator Note Value screen. See “Velocity” on page 61.

Arpeggiator Gate (ArpGate)

This control changes the Arpeggiator Gate Time. It *adds* to the gate time set in the Arpeggiator Gate Time screen. See “Gate Time” on page 61.

Arpeggiator Interval (ArpIntvl)

This control modulates the Arpeggiator Extension Interval. It *adds* to the extension programmed in the Arpeggiator Extension Interval screen. See “Extension Interval” on page 62.

The Master Arpeggiator is defined in the Arp menu. The Arpeggiator mode selected on the Main Screen determines whether the Master arpeggiator or the Preset menu arpeggiator settings are used.

► To Access the Master Arpeggiator Parameters:

1. Press the **Arp** menu button lighting the LED. The Arpeggiator menu screen displays the menu page most recently selected since powering up XK-6. The cursor appears below the first character of the screen heading on line one.
2. Use the right **cursor** button to advance the cursor to the first field in the bottom line of the screen.
3. Now, use the **data entry control** to access the various Master Arpeggiator parameters.
4. **Save** your Arpeggiator settings using the “Save Setup” function on the Multi menu.

Master Arpeggiator Parameters

Status

The Status parameter turns the Master Arpeggiator on and off. The Channel Arpeggiator setting in the main screen overrides this setting. For example, if you set the Arpeggiator in the main screen to “off,” and turn it “on” here, it still will not play.

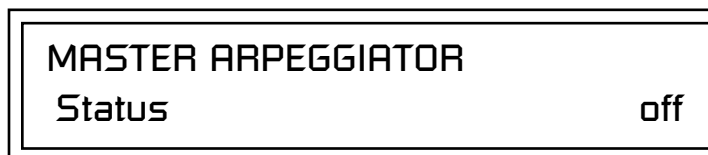

Mode

The Mode parameter determines the direction or pattern mode of the arpeggiated notes.

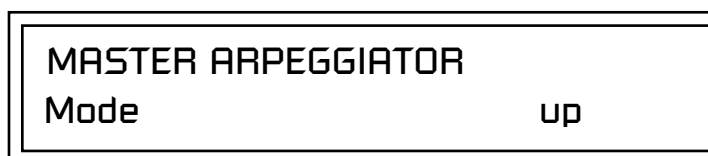



The eight arpeggiator modes are:

- **Up** Held notes arpeggiate continuously from lowest to highest pitch.
- **Down** Held notes arpeggiate continuously from highest to lowest pitch.
- **Up/Down** Held notes arpeggiate continuously from lowest to highest pitch, then from highest to lowest, then repeat this cycle.
- **Fwd Assign** Held notes arpeggiate continuously in the order in which the keys were pressed.
- **Bkwd Assign** Held notes arpeggiate continuously in the reverse order in which the keys were pressed.
- **Fwd/Bkwd** Held notes arpeggiate continuously in the order in which the keys were pressed, then arpeggiate in the reverse order that they were pressed. The cycle is then repeated.
- **Random** Held notes arpeggiate continuously in a random fashion.
- **Pattern** Held notes play the selected pattern (see “Pattern” on page 60 for details).

Note Value

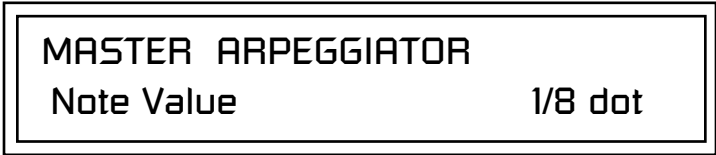
The Note Value determines the duration of each note played. This parameter is used in non-pattern mode only.



 Note value has no effect when the mode is set to "pattern."

Following is a list of possible Note Values and the relative number of clocks used for each.

Note Value	MIDI Clock
Double Whole Note	192
Dotted Whole Note	144
Double Note Triplet.....	128
Whole Note	96
Dotted Half Note	72
Whole Note Triplet.....	64
Half Note	48
Dotted Quarter Note	36
Half Note Triplet.....	32
Quarter Note	24
Dotted Eighth Note	18
Quarter Note Triplet	16
8th Note	12
Dotted 16th Note	9
8th Note Triplet.....	8
16th Note	6
Dotted 32nd Note	4.5
16th Note Triplet.....	4
32nd Note	3

Arpeggiator Pattern Speed

The Arpeggiator Pattern Speed parameter lets you change the playback rate of Patterns by 1/4x, 1/2x, 1x (normal), 2x or 4x normal speed.

Pattern

This field lets you choose the pattern used when the arpeggiator Mode is set to "Pattern." There are 200 factory programmed patterns and you can create an additional 100 user definable patterns (see "Editing a User Arpeggiator Pattern" on page 67).

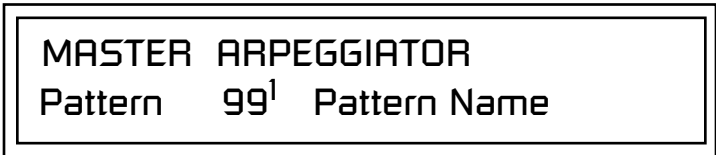

Velocity

 Controller Knob O is programmed to control Arp Velocity.

The Velocity parameter determines the velocity at which each note arpeggiates. Velocity can be defined by the velocity value specified (from 1 through 127), or by the actual velocity of the played note (played). Bear in mind that velocity values do not have an effect on the sound unless the preset is programmed to respond to velocity.

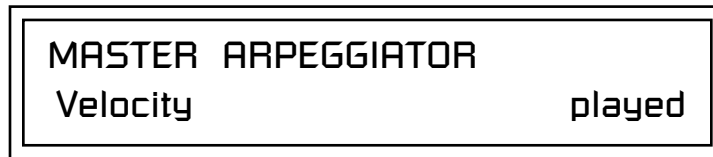

Gate Time

 Controller Knob P is programmed to control Arp Gate Time.

The Gate Time parameter works together with the Note Value parameter. Just as Note Value defines the length of a note, the Gate Time sets the percentage of the Note Value time played. This can have a dramatic effect on the sound depending on how the envelope generators are programmed.

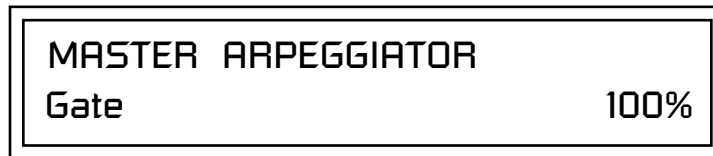

 The **note-on** time is used for the start-of-time when calculating note durations. See "Duration" on page 64.

With a Gate Time setting of 100% the note is held on until the next note starts. The envelope generators never advance to the Release stages. With a Gate Time setting of 50%, the note is released halfway through the note cycle and the envelope generators proceed to their release stages until the next note occurs. Refer to the following illustration.

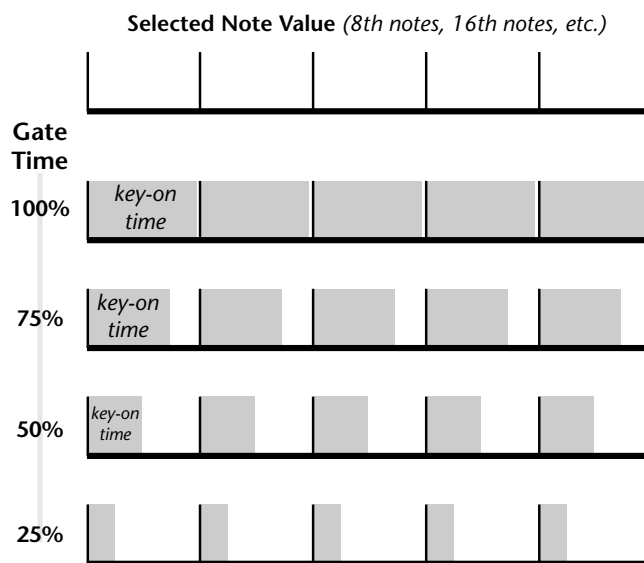

Extension Count

The Extension Count parameter specifies how many times the Extension Interval is carried out. With an Extension Count of 0, the arpeggio plays only the notes pressed. With an Extension Count of 1, the arpeggio plays the notes pressed, then plays the same notes (in the same order), transposed by the Extension Interval amount. The cycle is then repeated.



For example, with the Extension Interval set to 12 (an octave) and an Extension Count of 2, and with the Arpeggiator Mode set to Fwd Assign, if you played E2, then C2, then G2, the arpeggiated sequence would consist of: E2, C2, G2, then E3, C3, G3, and then E4, C4, G4. The Extension Count values range from 0 through 15. Refer to the following illustration.

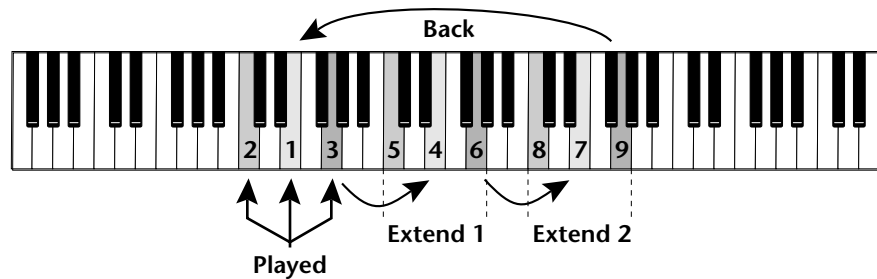

Extension Interval

The Extension Interval specifies the additional intervals played when you press a key. For example, suppose you played C2 with an Interval of 7 (a Major 5th), Up mode, and an Extension Count of 2. The arpeggio alternates between C2 and G2.

The Extension Interval values range from 1 through 16.

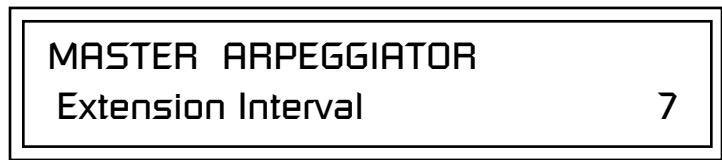

Sync

The Sync parameter defines when a note is played in relation to when the key is pressed. When set to “Key Sync”, the note sounds the instant a key is pressed. When set to “Quantized”, the note does not sound until the next occurrence of the selected note value.

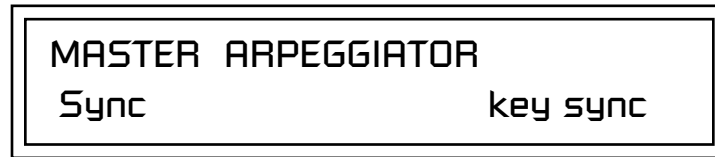

The following diagram illustrates how Key Sync and Quantize work.

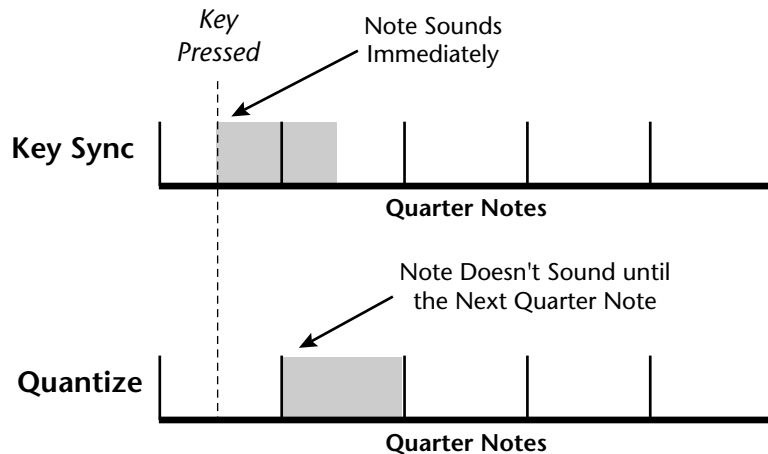

Pre-Delay

The Pre-Delay value determines how long the arpeggiator is delayed before becoming active after the first “note-on.” During the pre-delay period, notes are played normally (as if the arpeggiator was off). After the pre-delay period has elapsed, the arpeggiator kicks in. Once you release all the keys on the controller, the pre-delay starts over with the next note-on. In combination with the Duration parameter, Pre-Delay lets you create many more variations in the arpeggio patterns. *Please refer to the diagram on page 65.*

You can play the preset normally as long as you don't hold the notes longer than the Pre-Delay. If you do, the arpeggiator starts in. When used in conjunction with multiple arpeggiators, Pre-Delay allows you to offset the time between the different patterns.

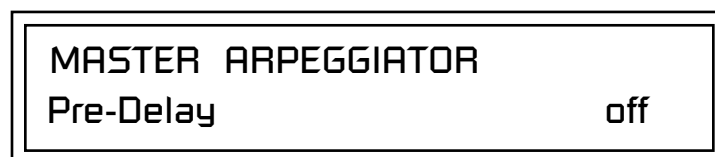

Duration

This parameter defines how long the arpeggiator plays before stopping. The Duration is specified in note values. Therefore if an arpeggio were running at a 16th *Note Value* and the Duration were set to a whole note, the arpeggiator would play 16 steps before stopping. After the duration has elapsed, the arpeggiator remains inactive until the key is released. If Duration is set to Off, the arpeggio repeats as long as the notes are held (Infinite Duration).

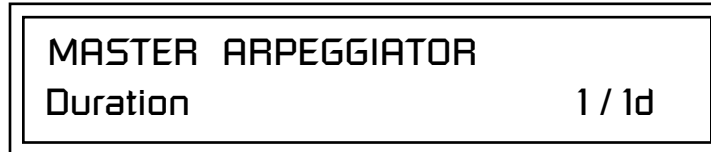

Duration can be used to modify the patterns and increase the possible pattern combinations and variations. Because this parameter limits the length of arpeggiator play time, it can change the arpeggio pattern when the Duration is less than the length of the arpeggio. You can set the arpeggio to repeat continuously using the *Recycle* function described below.

Post-Delay

This parameter is only relevant when both the "Duration" and "Recycle" parameters are not in the "Off" state. The Post-Delay value determines how long the arpeggiator is delayed after the Duration period. *Please refer to the diagram on page 65.* During the post-delay period, notes are played normally (as if the arpeggiator was off). After the post-delay period has elapsed, the arpeggiator either jumps to the beginning of the Pre-Delay period or to the beginning of the Duration period depending on the Recycle setting.

If the arpeggiator is playing an extension when the Duration expires, the notes in the extension will continue to sound during the Post-Delay (*and Pre-Delay if on*). On the next pass through the Duration period, the extension continues where it left off.

Post-Delay increases the number of possible variations in the beat and allows the recycle loop to be set to an exact measure of time.

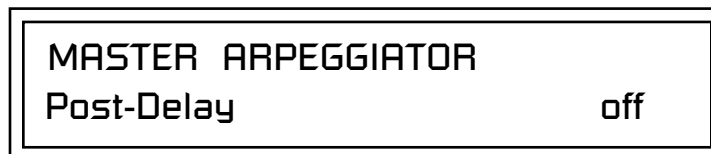

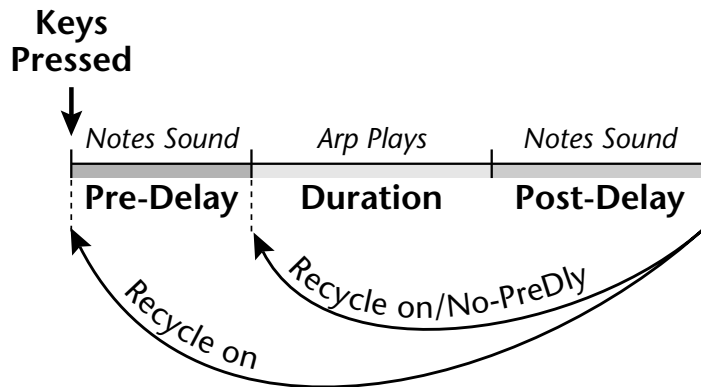

Recycle

Recycle enables the pattern or arpeggio to repeat. This parameter works together with the *Duration* and *Pre/Post Delay* parameters to allow the loop to be set to an exact measure of time. The “on/No-PreDelay” option bypasses the predelay period. With Recycle turned Off, the pattern or arpeggio stops at the end of the Post-Delay period.

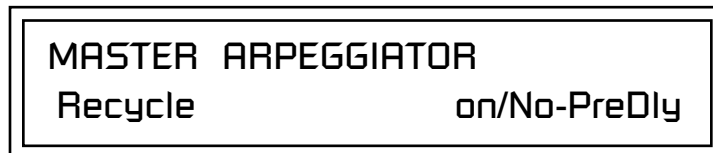

Keyboard Thru

When enabled, Keyboard Thru merges the notes not arpeggiated with the notes being produced by the arpeggiator. This gives the effect of two parts playing at once.

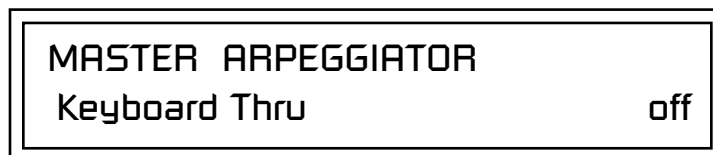

Latch

With Latch mode On, any notes you play remain on until you press them again. Latched notes can also be halted by turning Latch off in this screen, or by turning off the Arpeggiator for the channel in the main screen.

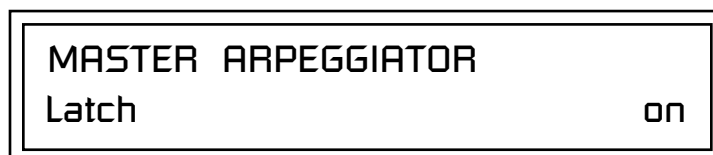

Send MIDI System Exclusive Data



Send data as you would a regular sequence. Sending data in one huge chunk may clog the MIDI input buffer on XK-6.

Use the Key Range parameter to set the keyboard range for the arpeggiator. Notes inside the range will arpeggiate while notes outside the specified range will not arpeggiate. Use the Extensions parameters to exceed the upper boundary of the Key Range (see the information about Extensions beginning on page 62).

MASTER ARPEGGIATOR	
Key Range	C-2->G8

Move the cursor under the first key and use the data entry control to define the lowest key to be arpeggiated. Move the cursor under the second key value and use the data entry control to define the highest key to be arpeggiated.

Transmits the Arpeggiator Patterns via the MIDI out port as MIDI System Exclusive data to another XK-6 or to a computer/sequencer for backup. Using the cursor key and the data entry control, select the MIDI data you want to transmit. See *Send MIDI System Exclusive Data* in the Master chapter for additional details about recording SysEx.

User Patterns

Transmits all the User patterns.

00⁰ to 99⁰

Transmits only the individual pattern you have selected.

SEND MIDI SYSEX DATA	
All User Arp Patterns	

Editing a User Arpeggiator Pattern

Bank 0 = User Patterns
Bank 1 = Factory Patterns
Bank 2 = Factory Patterns

 Before editing a Pattern, select Master Arpeggiator (M) in the main screen and set the Arpeggiator to the Pattern you are editing. This lets you hear the Pattern as you edit it.

XX-6 lets you create and edit your own arpeggiator patterns. Using the Edit User Pattern menu, you can create up to 100 user patterns and each pattern can be up to 32 steps in length.

When you edit a pattern, you are writing directly into memory—no Save command is required (however, you must exit the Arp module). This is different from the Edit menu where you must Save a preset before it will be overwritten. If you want to modify an existing pattern and keep the original, you must first COPY the pattern you want to edit to another location using the function in the Save/Copy menu (See page 191). Refer to the instructions below and the following parameter descriptions to create your own patterns.

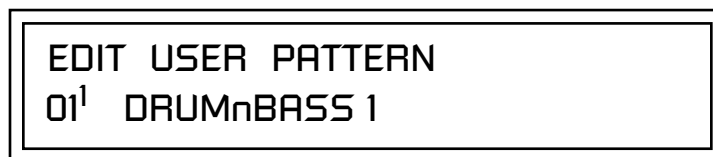

► To Select the Pattern to Edit:

1. From the Edit User Pattern screen shown above, move the cursor to the bottom line and **select the pattern** you want to edit. The Enter LED begins flashing. Press **Enter** to move back to the Home position.
2. Select the **next screen** in the list, "User Pattern Edit". This is where you edit the currently selected pattern.

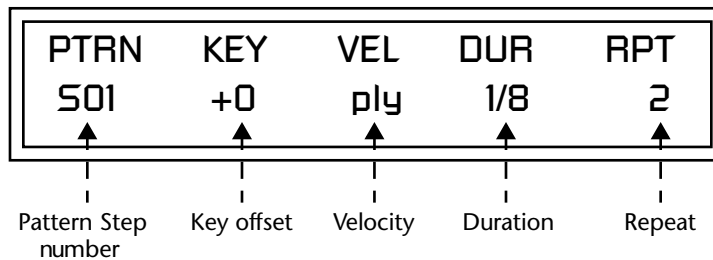

3. Move the cursor to the **lower line** of the display. For each step, you can select: key, velocity, duration, and number of repeats.

Pattern Step Number

You can set up to 32 steps for each arpeggiator pattern. This field selects which step you will be editing from 1 to 32.

Key

This parameter defines what happens during the current step. The Key parameter can do one of five different operations. Following is a description of each of the key functions and how to use them.

Key Offset

This parameter defines not the actual note of the arpeggiator playback, but instead specifies the amount of offset, in semitones, from the original note played. You can set a Key Offset from -48 to +48 for each step. For example, if you play a "C" on the keyboard with the Key Offset amount for the first step set to "+1," the first step in the pattern will be "C#."

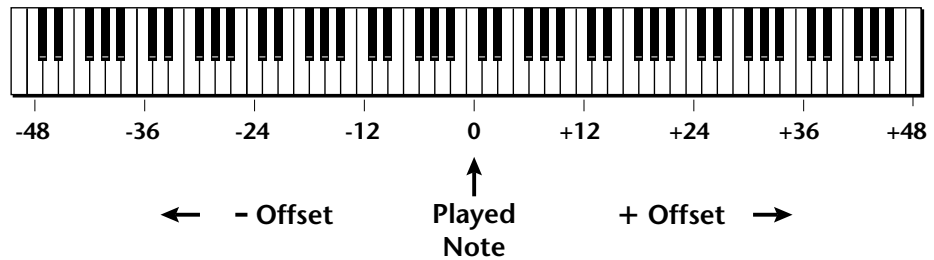

Tie

This function *extends* the duration of notes beyond the values given in the duration field by "tying" notes together. You can tie together any number of consecutive steps.



IMPORTANT: The Gate function in the arpeggiator *MUST* be set to 100% when using the tie function, otherwise the tied note is retriggered instead of extended.

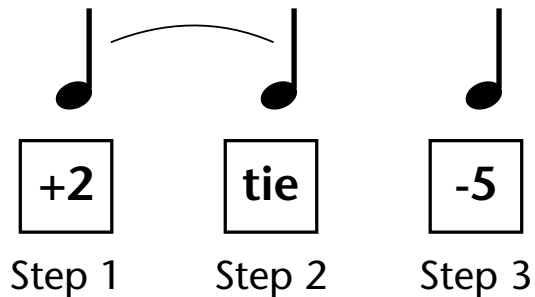

Rest

Instead of playing a note, you can define the step as a Rest. The Duration parameter specifies the length of the rest. Rests can be tied together to form longer rests.

Skip

This command simply removes the step from the pattern. The Skip feature makes it easy to remove an unwanted step without rearranging the entire pattern. You'll be happy to know that the velocity, duration and repeat parameters are remembered if you decide to put the step back later.

End

This command signals the end of the pattern. Any steps programmed after the step containing the End command are ignored.

Velocity

Each note in the pattern plays using either a preset velocity value (from 1 through 127), or using the actual velocity of the played note (ply).

Note: Velocity values will not have an effect on the sound unless velocity is programmed to do something in the preset.

Duration

This parameter sets the length of time for the current step, defined as a note value, based on the Master Tempo. The selectable note durations are described below.

1/32	32nd Note	1/2t	Half Note Triplet
1/16t	16th Note Triplet	1/4d	Dotted Quarter Note
1/32d	Dotted 32nd Note	1/2	Half Note
1/16	16th Note	1/1d	Dotted Whole Note
1/8t	8th Note Triplet	1/1t	Whole Note Triplet
1/16d	Dotted 16th Note	1/2d	Dotted Half Note
1/8	8th Note	1/1	Whole Note
1/4t	Quarter Note Triplet	2/1t	Double Whole Note Triplet
1/8d	Dotted Eighth Note	2/1	Double Whole Note
1/4	Quarter Note		

Repeat

Each step can be played from 1 to 32 times. A repeat setting of "1" indicates the step will be played one time (not repeated one time or played twice).

► To Edit a User Pattern:

1. The first field in the Edit User Pattern field defines the pattern's step number. Start with the pattern Step 01.
2. Define the Key Offset, Velocity, Duration and Repeat values.
3. Repeat steps 1 and 2 until you have setup the desired number of steps in the pattern.
4. Set the Key Offset to "End" on the last step in the pattern.

User Pattern Name

The User Pattern Name page lets you enter a name for any User Arpeggiator Pattern.

<u>P</u> TRN	KEY	VEL	DUR	RPT
S01	+0	ply	1/8	2

► To Name a User Pattern:

1. From the Pattern Edit screen shown above, position the cursor under the **PTRN** field.
2. Turn the **data entry control** clockwise. The following screen appears.

<u>U</u> SER PATTERN NAME
00 ⁰ Mod Cycle

3. Move the cursor to the bottom line and **edit the Pattern** name using the data entry control and Cursor keys.
4. Move the cursor to the “**Home**” position (shown above) by pressing the **Home/Enter** button.
5. Turn the **data entry control** counter-clockwise one click to return to the Pattern Edit screen.
6. Turn the **data entry control** counterclockwise multiple clicks to jump back to the main Arpeggiator menu screen.

Multichannel Arpeggiating

Presets with the arpeggiator assigned will play when they receive note-on data from the keyboard or external MIDI source.

Please refer to the instructions on page 26 to learn one way to perform using multiple arpeggiators.

Controllers Menu

The Controllers menu contains functions related to the keyboard, knobs or trigger buttons of XK-6. For example, the Command Function Trigger Keys are programmed in this menu. All Controllers menu data is saved with the Multisetup. See page 41 for more information about Multisetups.

▶ **To enable the Controllers menu:**

Press the Controllers button, lighting the LED. The Controllers Menu screen displays the menu page most recently selected since powering up XK-6. The cursor appears below the first character of the screen heading on line one.

▶ **To select a new screen:**

Press the Home/Enter button or press the Cursor button repeatedly until the cursor is below the screen title heading. Rotate the data entry control to select another screen.

▶ **To modify a parameter:**

Press either Cursor button repeatedly (or hold down the right cursor button while turning the data entry control) until the cursor is below the desired parameter value. Rotate the data entry control to change the value.

▶ **To return to the previously selected Mode/View screen:**

Press the Controllers button, turning off the LED.

Realtime Control Functions

Keyboard Channel



in Quick Edit mode the front panel knobs only control the "Basic Channel".

This section describes how set up the Realtime Controllers on XK-6. Realtime Controllers are performance controls such as the controller knobs, velocity & pressure sensitive keyboard, and the trigger buttons.

This option allows you to select which channel is controlled by the Keyboard, Knobs as well as the Pitch & Mod Wheels. You can select any of the 16 channels or "Basic". If the "Basic" channel is selected, the keyboard and knobs always control the preset showing in the Main screen.

KEYBOARD CHANNEL
Channel: Basic

Keyboard Transpose

This option allows you to offset the transposition of the keyboard in semitone intervals. This allows you to easily play in different keys with the keyboard and lets you access different groups of instruments in a drum map. The transpose range is ± 36 semitones.

KEYBOARD TRANSPOSE
+00 semitones

Local Control On/Off

Local Control is used to disconnect the keyboard and controllers (knobs, wheels, footswitches) from the sound generating section. Even though disconnected from the internal synthesizer, the keyboard and controllers are still transmitted over MIDI. Local Control is normally turned Off when recording into an external MIDI sequencer (set sequencer to Echo Thru). Played data and recorded data are merged in the computer sequencer and then sent back to the module. This feature can also be used if you want to control another MIDI sound generator from the keyboard and knobs without playing internal sounds.

LOCAL CONTROL ON/OFF
on

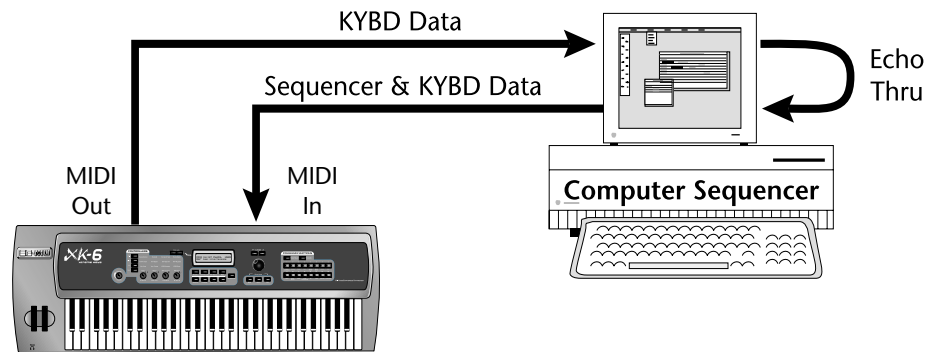

Turning Local Control Off allows you to use the Echo Thru feature on your sequencer while sequencing. In conjunction with Echo Thru, Local Control Off allows you to record into the external sequencer and hear the correct sounds whether you are recording or playing back the sequence.

Keyboard Velocity Curve

The velocity response of the keyboard can be adjusted using any of 17 curves in order to customize the dynamic feel of the keyboard to your individual playing style. This curve adjusts the output of the XK-6 keyboard before it is sent to the MIDI output port and to the Master Velocity Curve described on page 85.



The Keyboard Velocity Curve diagrams are located on page 232.

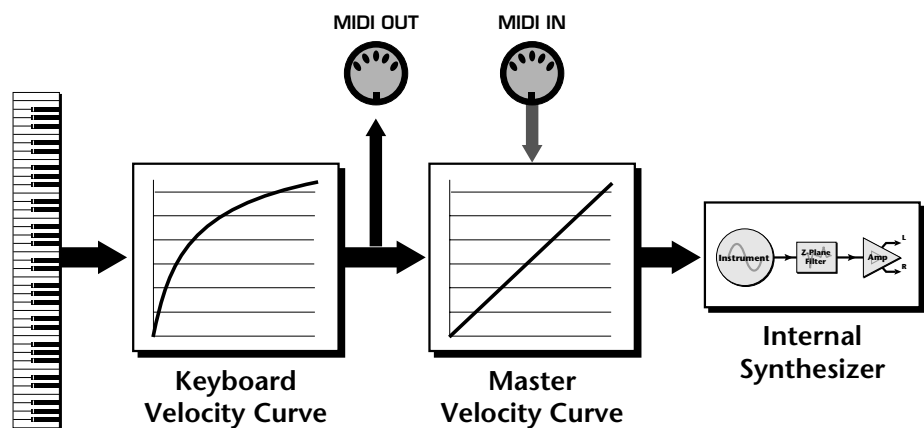

The Keyboard Velocity Curve modifies the velocity data from the keyboard keys. This data is sent to the MIDI output port and through the Master Velocity Curve before reaching the Synthesizer. Incoming MIDI data is filtered through the Master Velocity Curve only.

Channel Aftertouch On/Off

The keyboard generates channel aftertouch messages. Aftertouch is generated when you continue to press the keys *after* the note has been played. Aftertouch can be a very useful controller for adding a bit of vibrato or creating a volume swell. Aftertouch is routed to the **Pressure** source in the PatchCord screen. This control allows you to turn aftertouch on or off without having to modify each preset.

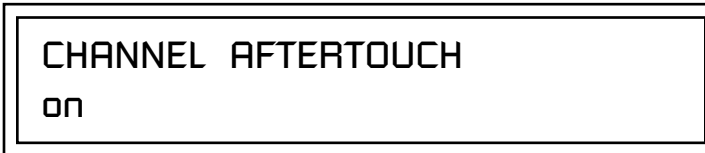

Footswitch Function

The footswitch jack on XK-6's rear panel can be programmed to perform a variety of functions. The footswitch jack is designed to accept a momentary footswitches which shorts the tip and ground. XK-6 senses either normally-on or normally-off switches on power-up.

The following functions can be controlled via the footswitches.

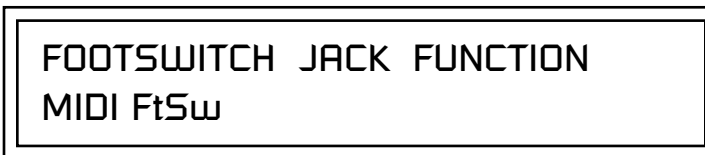

- **MIDI Footswitch** In this mode the footswitch is routed to the "FootSw1" PatchCord source in the Preset Edit, Cords menu. (See pages 159 and 166.) It is also transmitted out on the Footswitch Controller number as programmed in the Controllers menu. (See page 80.)
- **Tap Tempo** Pressing the footswitch allows you to tap in the current tempo with your foot.
- **Channel +** Pressing the footswitch increments the MIDI channel number.
- **Channel -** Pressing the footswitch decrements the MIDI channel number.
- **Preset +** Pressing the footswitch increments the current preset number.
- **Preset -** Pressing the footswitch decrements the current preset number.

Foot Pedal Function

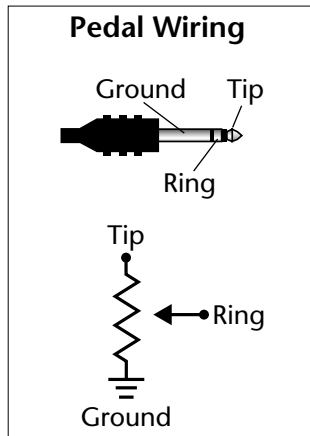

The foot pedal jack on XK-6's rear panel can be programmed to perform a variety of functions. The foot pedal input can sense either 0-5 volts on the ring of a stereo jack or a foot pedal with the potentiometer wired as shown at left.

The following functions can be controlled via the foot pedal jack.

FOOT PEDAL FUNCTION FootCtrl

- **Foot Controller** In this mode the Foot Pedal is routed to the "Pedal" PatchCord source in the Preset Edit, Cords menu. (See pages 159 and 166.) It is also transmitted out on MIDI Continuous Controller #4 on the basic MIDI channel.
- **Channel Volume** The Foot Pedal controls the volume of the current channel. (The MIDI channel currently showing in the main screen.) Channel volume is pre-effect—reverb or echoes will continue to sound even when the pedal is off.
- **Master Volume** The Foot Pedal controls the overall volume of the XK-6. This duplicates the function of the Master Volume knob on the front panel. Master volume is post-effect—effects will be cut off when the pedal is off.

Trigger Buttons Function

This option selects the function of the front panel "Triggers" button. The "Triggers" button can be used either to **Play Beats Parts** or to **Play Note Events**.

- **Play Beats Parts** In this mode and when the Triggers button is selected, the sixteen command buttons turn Beats parts on and off.
- **Play Note Events** In this mode and when the Triggers button is selected, the sixteen command buttons work like keyboard notes. Each button can be assigned to any MIDI note, on any MIDI Channel (01-16), with any velocity (0-127), and can be set to be latched or momentarily on.

TRIGGER BUTTONS FUNCTION Play Note Events

Trigger Buttons

 By assigning Trigger Buttons to the keyboard Beats Layout Keys (page 51), you can trigger Beats and MIDI notes using the Trigger buttons.

 Latched buttons are especially useful for triggering arpeggiated presets.

This screen allows you to program the 16 trigger buttons to play note events. **Note:** This screen is not available when the “Trigger Buttons Function” (see *previous page*) is set to “Play Beats Parts”.

Set the previous screen to “Play Note Events”. Select Triggers mode by pressing the mode select button so that the “Triggers” LED is illuminated. Now the 16 buttons work like keyboard notes. Each of the 16 buttons can be assigned to any MIDI note, on any MIDI Channel (01-16), with any velocity (0-127), and can be set to be latched or momentarily on. Latched notes will hold until the button is pressed again. Latched notes will be indicated by the LEDs.

Simply move the cursor from the “TRIGGERS” field and play a note to enter the MIDI key and velocity. Pressing a Trigger Button anytime while in this screen automatically selects that trigger button for programming!

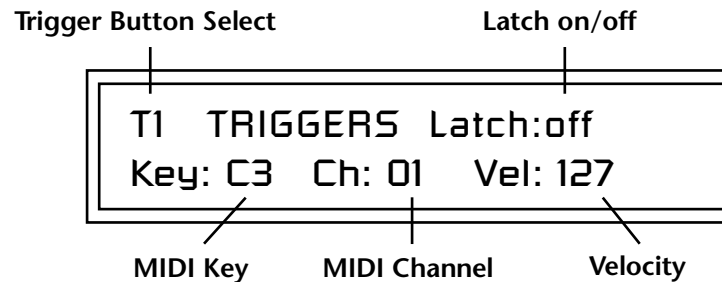

► To Setup the Trigger Buttons:

1. Press the Controllers button. Its LED will illuminate.
2. Turn the data entry control to select the “TRIGGERS” screen.
3. Use the left/right cursor controls to select the fields shown above.
4. Select the MIDI key, the MIDI channel, the Velocity and Latch on/off for each of the 16 trigger buttons.
5. Save the Multisetup if you want to save these settings. See page 42.

► To Play the Trigger Buttons:

1. Press the Controllers button. Its LED will illuminate.
2. Turn the data entry control to select the “TRIGGERS BUTTONS FUNCTION” screen.
3. Move the cursor to the lower line and select “Play Note Events”.
4. Press the Command Functions “Triggers” button so that its LED illuminates.
5. Play the Trigger buttons.

Preset Select Buttons



The Basic MIDI channel is the channel currently showing in the main screen.

The 16 command buttons can also be used for preset selection. Each button can be programmed to select any preset on the Basic MIDI channel. For your next song, selecting another Multisetup (page 41) selects another group of sixteen presets.

In Preset Select mode, whenever the current preset on the basic channel matches any of the 16 “favorites” assigned to the Preset Select buttons, its LED will illuminate.

Select Preset Select mode from the Command Functions. Now the 16 buttons are programmable preset selection buttons.

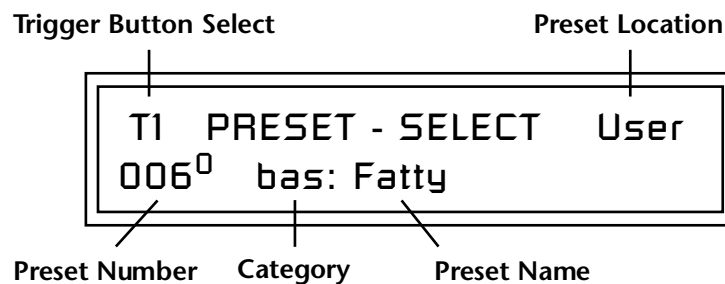

When a preset is selected using the Preset Select buttons, the cursor is automatically located underneath the Preset Name field. This feature makes it easy to select other presets of the same type.

► Quick Method of Programming the Preset Select Buttons:

1. Select the preset you want from the Main screen.
2. Press and hold the **Preset Select** button, then press one of the sixteen **Trigger** buttons.
3. The preset will be stored in the trigger button you selected.

► To Program the Preset Select Buttons from the Menu:

1. Press the **Controllers** button. Its LED will illuminate.
2. Turn the **data entry control** to select the “PRESET - SELECT” screen.
3. Use the left/right cursor controls to select the fields shown above.
4. Select the desired preset for each of the 16 trigger buttons.
5. Save the Multisetup if you want to save these settings. See page 42.

► To Use the Preset Select Buttons:

1. From the main preset selection screen, press the **Preset Select** button. Its LED will illuminate.
2. Press any of the 16 buttons to select a new preset.

Preset Select Send Buttons

Suppose you wanted to send another MIDI program change message to an external synthesizer. The 16 command buttons can also send external MIDI program changes on the Basic MIDI channel. Each button can be programmed to select any preset from 0-127, in any bank.

Select Preset Select mode from the Command Functions. Now the 16 buttons are programmable preset selection buttons.

Trigger Button Select

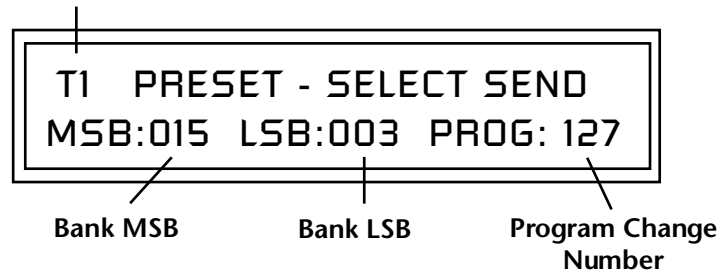

► To Program the Program Change Send Buttons:

1. Press the Controllers button. Its LED will illuminate.
2. Turn the data entry control to select the "PRESET - SELECT SEND" screen.
3. Use the left/right cursor controls to select the fields shown above.
4. Select the desired program change and bank for each of the 16 trigger buttons. (If you don't want to send an external program change, set the fields to "off".)
5. Save the Multisetup if you want to save these settings. See page 42.

► To Send an External Program Change:

1. From the main preset selection screen, press the **Preset Select** button. Its LED will illuminate.
2. Press one of the 16 buttons to send the program change.

Knob Preset Quick-Edit

“Quick-Edit” changes the initial controller setting in the preset whenever you move a Control Knob. This parameter selects whether or not the front panel Controller Knobs are used to Quick-Edit the currently selected preset. See “Preset Edit Button” on page 32 in the Operations chapter for more details.

KNOB'S PRESET QUICK-EDIT
disabled

Real-time Controller Assignment

Use these three pages to assign sixteen real-time control sources. Each MIDI Controller is assigned a letter (A - P). The front panel Controller Knobs *and* sixteen MIDI controller numbers share the A-P controller routings. **These screens let you select which MIDI real-time controllers numbers will be received (from 1 to 31 and from 64 to 95) and which controller numbers will be transmitted over MIDI if the front panel controls are turned.** The PatchCord routing and amount in the Preset Edit menu determine what effect the controller has on each preset. Real-time controllers are shown in the PatchCord menu as MIDI A through MIDI P.

The Real-time Controller assignment also specifies which controller numbers are transmitted when the “Knobs Output MIDI” is enabled (see “Knobs Output MIDI” on page 94).



Tip: XK-6 factory presets have certain synth parameters assigned to each controller letter and so these are “Global” controller assignments.

For example, assigning a MIDI controller to “A” in this screen would let you control filter Fc for all the factory presets. See “Front Panel Knob Functions” on page 209.

REALTIME CONTROLLER #
A: 74 B: 71 C: 25 D: 26

REALTIME CONTROLLER #
E: 73 F: 75 G: 85 H: 72

REALTIME CONTROLLER #
I: 78 J: 77 K: 27 L: 28

REALTIME CONTROLLER #
M: 01 N: 03 O: 82 P: 83

Note: Controllers 7 and 10 are already assigned to Volume and Pan for each MIDI channel. Controllers 91 & 93 are the standard controller numbers for reverb and chorus send amounts, but are not assigned.

Following are a few of the standardized MIDI Controller numbers as defined by the MIDI manufacturers association. The controllers shown in **Bold** are automatically routed to the destination (volume & pan) or have their own PatchCord source. Others, such as Portamento Time, can be routed using a PatchCord to have the desired effect.

1 - Modulation Wheel	7 - Volume
2 - Breath Controller	8 - Balance
4 - Foot Pedal	9 - Undefined
5 - Portamento Time	10 - Pan
6 - Data Entry	11 - Expression

MIDI Footswitch Assign

Like the MIDI Controllers, you can assign three MIDI footswitches to MIDI footswitch numbers. Footswitches numbers are from 64-79. Destinations for the footswitch controllers are programmed in the PatchCord section of the Preset Edit menu. The rear panel footswitch 1 is connected to footswitch controller 1 in this screen. Pressing the footswitch transmits on the MIDI controller number programmed here. Footswitches 2 & 3 route incoming MIDI footswitch data to the PatchCord section of XK-6.

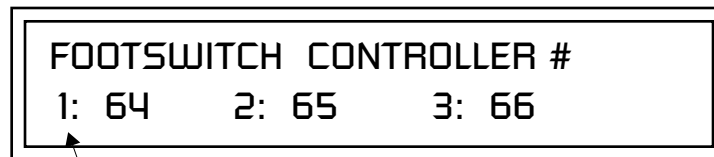

Rear panel footswitch input

Calibrate Controllers

 *The Controllers should ALWAYS be calibrated after you reinitialize user data. (And you should always reinitialize user data after updating the operating system.)*

This screen allows you to calibrate the Pitch Wheel, Modulation Wheel, Aftertouch, and Foot Pedal controller. The controls should be recalibrated periodically in order to compensate for normal changes in the controls themselves. If a control doesn't seem to be responding properly, it may simply need to be recalibrated.

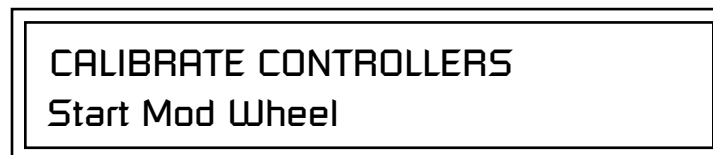

► **To Calibrate the Controllers:**

1. Press the Global button. Its LED will illuminate.
2. Turn the data entry control to select the “CALIBRATE CONTROLLERS” screen shown below.

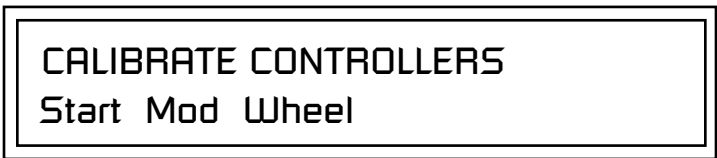

3. Move the cursor to the lower line of the display and rotate the Data Entry Control to select the control to be calibrated. The choices are:
 - **Mod Wheel** • **Pitch Wheel** • **Foot Pedal** • **Aftertouch**
4. Press **Enter** to select a control, then follow the instructions given in the display. You will be asked to move the control through its entire range (minimum through maximum), then press **Enter**.
5. In the case of the Pitch Wheel, you first move the wheel through its min-max range and leave the wheel resting in its center position. Then press **Enter**.

Tempo Controller

This function allows a MIDI controller to change the Base Tempo of the Master Clock. The Master Clock is used by the arpeggiators, clock divisor PatchCords, tempo-based envelopes and synced LFOs. (See “Clock Modulation” on page 106.) You can assign any controller number from 0-31, mono key pressure, or the Pitch Wheel to change the Global Tempo.

A different controller can be used to change the tempo up or down. The Pitch Wheel can be assigned to both the up and down parameters to vary the tempo up and down from a single controller. If any other controller is assigned to both the up and down parameters, XK-6 redefines the center of the controller’s range as zero (so it acts like a pitch wheel).

MIDI Controller values are added to the Base Tempo with a range of ± 64 . When the controller is set to “off” the tempo returns to its original setting. Controllers are only recognized on the selected MIDI channel, unless XK-6 is in Omni mode, in which case all channels are accepted. This control has no effect when using an external clock.



Base Tempo



The Arp/Beats LED flashes in time with the Base Tempo.



You can also tap tempo using a footswitch. See page 74.

XK-6 contains an internal Master Clock which runs the arpeggiators, synchronizes the LFOs when in tempo-based mode, controls the times of tempo-based envelopes, and can be used as a modulation source in the PatchCords section.

You'll notice that there are two tempo values shown in the display.

- **Base Tempo** - This is the base tempo setting before being modified by the Tempo Controller (if engaged). See "Tempo Controller" on page 81.
- **(Current Tempo)** - **This is the actual tempo!** The current tempo is equal to the base tempo modulated by the MIDI controller specified in the Tempo Controller screen. If no MIDI Tempo controller message has been received since the last Base Tempo change, the Current Tempo will be equal to the Base Tempo.

► To Change the Base Tempo:

1. Move the cursor to the lower line of the display.
2. Adjust the Base Tempo using the data entry control.

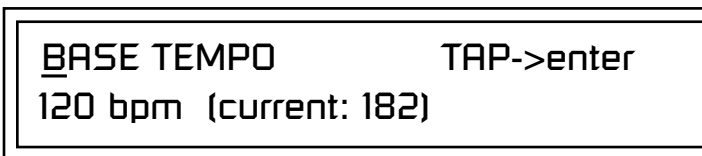

3. **To Tap Tempo** - Tap the Enter button at least three times. Keep tapping to continuously update the tempo on each tap. The tap tempo range is 25-300 bpm. The Base Tempo values range from 1 through 300 beats per minute (BPM).

► To Use an External MIDI Clock:

1. Move the cursor to the lower line of the display.
2. Turn the data entry control all the way counter-clockwise and select "ext" to use an external MIDI clock source.

Global Menu

The Global menu contains functions that affect the overall operation of XK-6. For example, changing the Master Tune parameter changes the tuning of all the presets, not just the one currently displayed.

▶ **To enable the Global menu:**

Press the Global button, lighting the LED. The Global Menu screen displays the menu page most recently selected since powering up XK-6. The cursor appears below the first character of the screen heading on line one.



Warning: Global Menu changes are automatically saved when you exit the menu. If the power is turned off before you exit the menu any changes you have made will be lost.

▶ **To select a new screen:**

Press the Home/Enter button or press the Cursor button repeatedly until the cursor is below the screen title heading. Rotate the data entry control to select another screen.

▶ **To modify a parameter:**

Press either Cursor button repeatedly (or hold down the right cursor button while turning the data entry control) until the cursor is below the desired parameter value. Rotate the data entry control to change the value.

▶ **To return to the previously selected screen:**

Press the Global button, turning off the LED.

Defining Global Parameters

Master Transpose/ Tune

Global setup parameters affect overall performance, range, and global effects. This section describes the Global parameters and how to define them.

The Transpose parameter transposes the key of all presets, in semitone intervals. The transpose range is ± 24 semitones.

Master Tune adjusts the fine tuning of all presets so that you can tune XK-6 to other instruments. The master tuning range is ± 1 semitone in 1/64th semitone increments (1.56 cents). A master tune setting of "+00" indicates that XK-6 is perfectly tuned to concert pitch (A=440 Hz).

MASTER TRANSPOSE +00 semitones	TUNE +00
--	--------------------

Master Bend Range

The Master Bend Range parameter sets the range of the pitch wheel. This affects only presets that have their individual Pitch Bend range (defined in the Preset Edit menu) set to Master. *See page 160.* The maximum pitch bend range is ± 12 semitones or one octave in each direction.

MASTER BEND RANGE +/- 7 semitones

Master Velocity Curve

 The Master Velocity curve is normally set to "Linear" and the Keyboard Velocity Curve is used to adjust the keyboard feel.

The two curves can also be combined if you wish.

Incoming velocity data or internal keyboard velocity can be altered by one of thirteen velocity curves. These curves are designed to adapt XK-6 to an external MIDI controller. You can select one of thirteen global velocity curves or to leave the data unaltered (linear). To adjust Keyboard velocity, see "Keyboard Velocity Curve" on page 73.

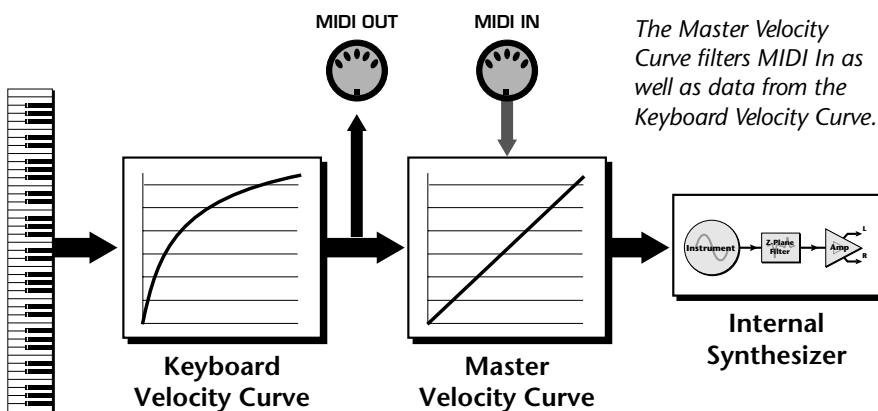
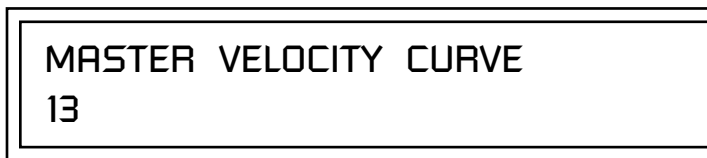

 For a complete list of all available velocity curves, see "Master Velocity Curves" on page 233 of the Appendix.

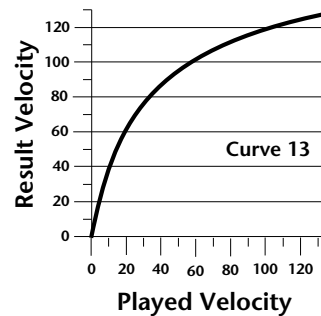
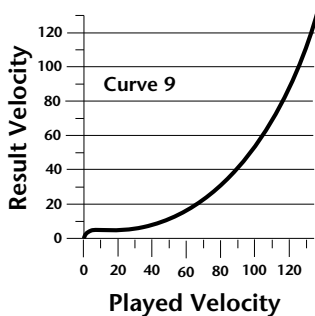
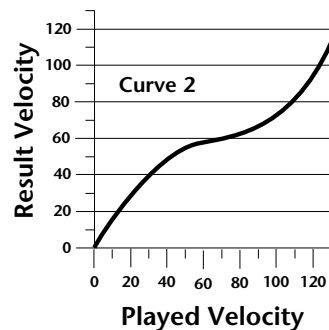
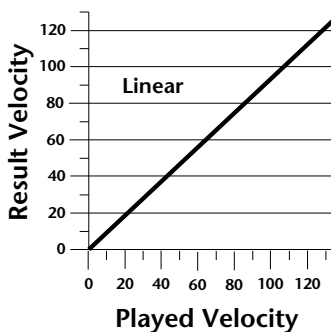

Mix Output

The Mix Output parameter allows you to override the routing assignments made in each preset and instead assign the outputs according to MIDI channel. For each of the 16 MIDI channels, you can select Send 1-4, or Preset. When Preset is selected, the output assignment defined in the Preset Edit menu is used.

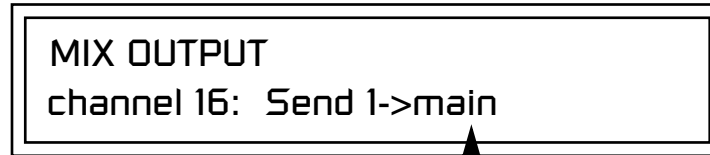

Indicates that the dry signal is routed to the Main output jacks.

The **Output Routing** field (pointed to by the arrow) reflects the true routing of Send 2 or Send 3 to either:

1) the effects processor input or... 2) the rear panel submix jacks.

Since the Sub 1 output is NOT being used, the signal is routed through the effects processors, then on to the main outputs. If a plug were inserted into one of the Sub 1 jacks the destination field would read "Sub1" for Send 2 and the dry signal would be routed directly to the Sub 1 outputs on the back panel.



The Sends function as effect processor inputs (effect sends). Send 2 is also used to route sounds to the Sub 1 outputs on the back panel. When a plug is inserted into the associated Submix jack on the back panel, **the Dry portion of the Send is disconnected** from the effects processor and the signal is routed directly to the output jack. **The Arrow points to the actual output routing.** If you don't want the wet portion of the signal in the main mix, turn down the Send Level. *The entire Send is disconnected from the Effects Processors even if only one plug is inserted into the Submix jack.*

The four Effect Sends allow you to get the most out of the two effect processors. For example, with Effect B set to an echo algorithm, you could route one MIDI channel to Send 3 and set the effect amount to 80%. Another MIDI channel could be routed to Send 4 with an effect amount of only 5%. This is almost like having two different effects!

The Mix Output function is also useful when sequencing since it lets you route specific MIDI channels to specific Sub outputs (on the back panel) where there they can be processed with EQ or other outboard effects.

Send Routings

- Send 1 - Main Outputs
- Send 2 - Subout 1 or Main Outs
- Send 3 - Main Outs
- Send 4 - Main Outputs

OUTPUT SECTION & EFFECTS PROCESSORS

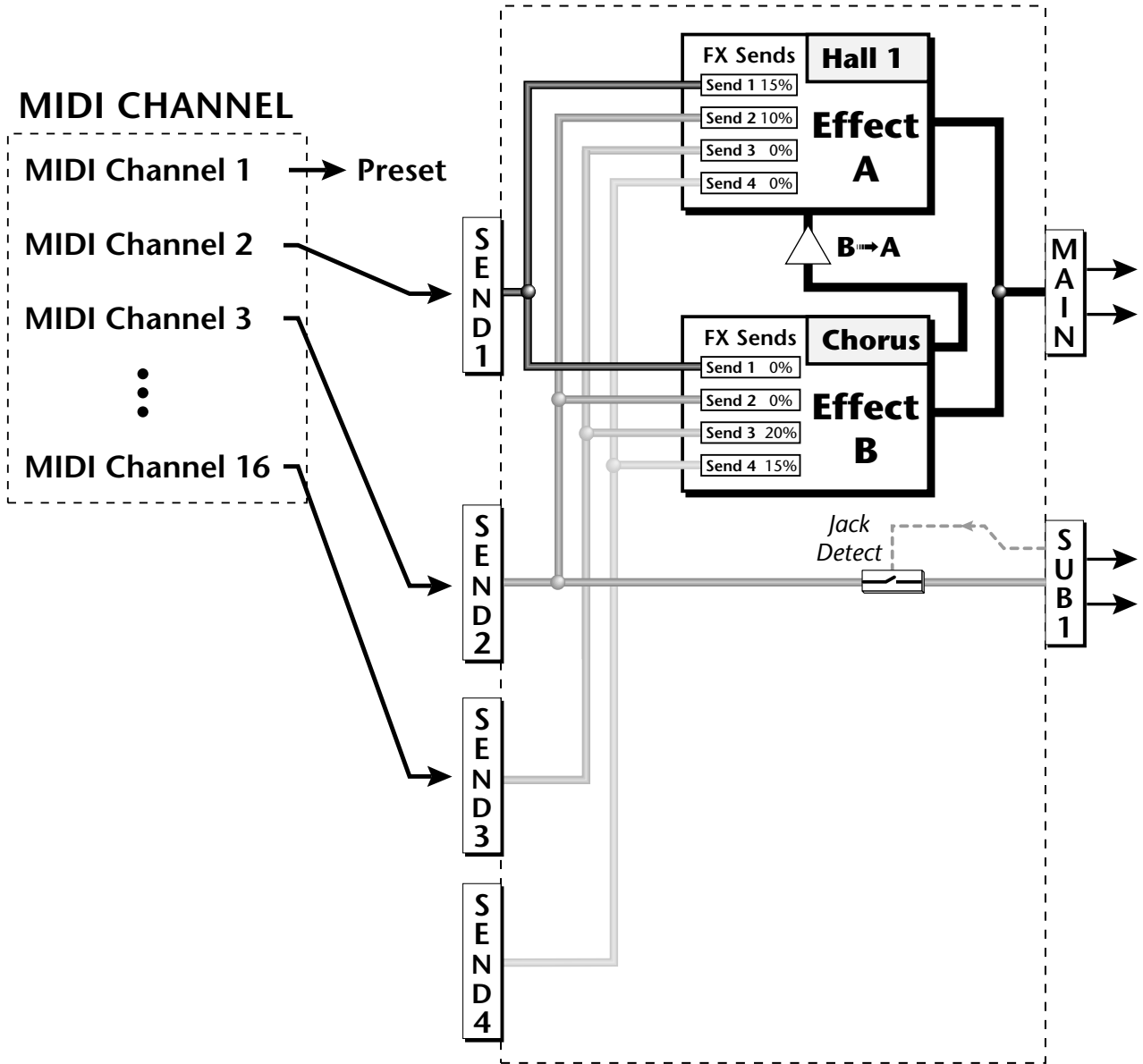

Send 2 can be routed to the effects processors or to rear panel submix jacks. When a plug is inserted into a Submix jack, the dry portion of the Send is disconnected from the effects processor and is routed **directly** to the Submix output jacks.

Master Effects

The digital effect processors can be programmed as part of the preset (using the Preset Edit menu) so that effects will change along with the preset. However, there are only two effect processors, and so you cannot have a different effect on each preset when in Multi mode.

The Master Effects settings assign the effect processors “globally” for all presets to provide a way to use the effects in Multi mode. Detailed information is presented in the Effects chapter (see Effects on page 173).

Effects Mode

The FX Mode page enables or bypasses the effects. When the FX Mode is set to “bypass,” the effects are turned off on a global scale. This includes Effects programmed in the preset.

FX MODE
enabled

Effects Multi Mode Control

The routing scheme for the two stereo effects processors provides a lot of versatility. When in multi mode, you can “use master settings” which applies the Master effects settings to all 16 MIDI channels.

FX MULTIMODE CONTROL
use master settings

If you want more control, you can use the “channel” setting which applies the effects settings of the preset on a specified channel to all the other channels. Changing the preset on the specified channel changes the effect.

FX MULTIMODE CONTROL
preset on channel 1

If you are in Omni or Poly modes this parameter is disabled and the message in parentheses explains that XK-6 is currently in Omni mode.

FX MULTIMODE CONTROL
(using Omni mode)

Master FXA Algorithm

This function selects the type of effect used for the “A” effect. The following effect types are available.

MASTER FXA ALGORITHM Room 1

A Effect Types

- | | |
|---------------------|-----------------------|
| 1. Room 1 | 23. BBall Court |
| 2. Room 2 | 24. Gymnasium |
| 3. Room 3 | 25. Cavern |
| 4. Hall 1 | 26. Concert 9 |
| 5. Hall 2 | 27. Concert 10 Pan |
| 6. Plate | 28. Reverse Gate |
| 7. Delay | 29. Gate 2 |
| 8. Panning Delay | 30. Gate Pan |
| 9. Multitap 1 | 31. Concert 11 |
| 10. Multitap Pan | 32. Medium Concert |
| 11. 3 Tap | 33. Large Concert |
| 12. 3 Tap Pan | 34. Large Concert Pan |
| 13. Soft Room | 35. Canyon |
| 14. Warm Room | 36. DelayVerb 1 |
| 15. Perfect Room | 37. DelayVerb 2 |
| 16. Tiled Room | 38. DelayVerb 3 |
| 17. Hard Plate | 39. DelayVerb 4 Pan |
| 18. Warm Hall | 40. DelayVerb 5 Pan |
| 19. Spacious Hall | 41. DelayVerb 6 |
| 20. Bright Hall | 42. DelayVerb 7 |
| 21. Bright Hall Pan | 43. DelayVerb 8 |
| 22. Bright Plate | 44. DelayVerb 9 |

*FXA Parameters:
Decay/HF Damping
FxB -> FxA*

This page lets you define the parameters of the selected Effects algorithm. Use this page to setup the effect decay, high frequency damping amount and to route "B" effects through the "A" effects. See "Effect Parameters" on page 175 for more details.

FXA	DECAY	HFDAMP	FxB>FxA
	040	096	001

FXA Send Amounts

These parameters set the effects amounts for each of the four stereo effects busses. See "Master Effects" on page 178 for detailed information.

FXA SEND AMOUNTS	1:100%
2: 50%	3: 10%
	4: 0%

*Master FxB
Algorithm*

This parameter selects the type of effect used for the "B" effect. The following effect types are available.

MASTER FxB ALGORITHM
Chorus 1

B Effect Types

- | | |
|----------------|------------------------|
| 1. Chorus 1 | 17. Ensemble |
| 2. Chorus 2 | 18. Delay |
| 3. Chorus 3 | 19. Delay Stereo |
| 4. Chorus 4 | 20. Delay Stereo 2 |
| 5. Chorus 5 | 21. Panning Delay |
| 6. Doubling | 22. Delay Chorus |
| 7. Slapback | 23. Pan Delay Chorus 1 |
| 8. Flange 1 | 24. Pan Delay Chorus 2 |
| 9. Flange 2 | 25. Dual Tap 1/3 |
| 10. Flange 3 | 26. Dual Tap 1/4 |
| 11. Flange 4 | 27. Vibrato |
| 12. Flange 5 | 28. Distortion 1 |
| 13. Flange 6 | 29. Distortion 2 |
| 14. Flange 7 | 30. Distorted Flange |
| 15. Big Chorus | 31. Distorted Chorus |
| 16. Symphonic | 32. Distorted Double |

FXB Parameters: Feedback/LFO Rate Delay Time

The FXB parameters setup the characteristics of the effect. Use this page to define the feedback amount, the LFO rate and delay amount for the selected type “B” effect. See “Effect Parameters” on page 175 for details.

FXB	FEEDBK	LFORATE	DELAY
	000	003	0

FXB Send Amounts

These parameters set the effects amounts for each of the four stereo effects busses. See the Effects chapter for detailed information.

FXB SEND AMOUNTS	1:100%
2: 50%	3: 10%
	4: 0%

Miscellaneous Parameters

Edit All Layers Enable

This function allows you to turn the Edit All Layers feature on or off. "Edit All Layers" is an Edit menu feature which allows you to select all layers (the letter "A" appears in the layer field) in order to edit all four layers simultaneously. Because this feature can be confusing to the beginning programmer, it can be disabled here in the Global menu.

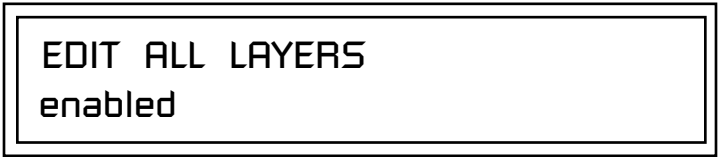

User Key Tuning

User Key Tuning lets you create and modify 12 user definable tuning tables. The initial frequency of every key can be individually tuned, facilitating the creation of alternate or microtonal scales.

Using the cursor keys and the data entry control, select the user table number, the key name, the coarse tuning and the fine tuning. The key name is variable from C-2 to G8. Coarse Tuning is variable from 0 to 127 semitones. The fine tuning is variable from 00 to 63 in increments of 1/64 of a semitone (approx. 1.56 cents). For each preset, the specific tuning table is selected in the Preset Edit menu. See page 168.



The user key tuning can be used to tune individual percussion instruments.

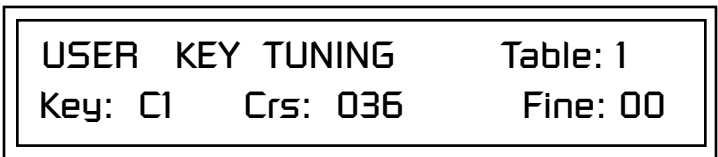

Screen Viewing Angle

This function changes the viewing angle of the display so that you can read it easily from either above or below the unit. The angle is adjustable from +7 to -8. Positive values will make the display easier to read when viewed from above. Negative values make the display easier to read from below.



MIDI Menu

Most of the parameters in XK-6 that relate to MIDI are contained within this menu. You can merge MIDI data, change the continuous controller assignments, turn program changes off or on, and lots more.

MIDI menu settings are saved with the current Multimap.

▶ **To enable the MIDI menu:**

Press the MIDI button, lighting the LED. The MIDI Menu screen displays the menu page most recently selected since powering up XK-6. The cursor appears below the first character of the screen heading on line one.

▶ **To select a new screen:**

Press the Home/Enter button or press the Cursor button repeatedly until the cursor is below the screen title heading. Rotate the data entry control to select another screen.

▶ **To modify a parameter:**

Press either Cursor button repeatedly (or hold down the right cursor button while turning the data entry control) until the cursor is below the desired parameter value. Rotate the data entry control to change the value.

▶ **To return to the previously selected Mode/View screen:**

Press the MIDI button, turning off the LED.



Warning: MIDI Menu changes are automatically saved when you exit the menu. If the power is turned off before you exit the menu any changes you have made will be lost.

Keyboard Outputs MIDI

This option allows you select whether or not the keyboard, pitch/mod wheel and footswitch data is transmitted on the MIDI output port. When this option is set to: “don’t transmit”, the keyboard, pitch/mod wheels, and footswitch only control the “current” preset. (*The current preset is the one currently showing in the Main screen*). The footswitch is transmitted on the MIDI CC number defined for Footswitch 1 in the Controllers menu.

KEYBOARD OUTPUTS MIDI
transmit

Knobs Output MIDI

This function allows you to select whether or not knob data is transmitted. The knobs transmit on the controller numbers defined by the Real-time Controller Assign parameter (See page 79).

KNOBS OUTPUT MIDI
don't transmit

Transmit MIDI Clock

This option enables or disables the transmission of MIDI clock from the MIDI out port. When XK-6 is running on its own internal clock (page 82) it transmits 24 MIDI clocks per quarter note. When XK-6 is slaved to an external MIDI clock, it mirrors the incoming clock data.

TRANSMIT MIDI CLOCK
off

MIDI Enable

MIDI Enable lets you turn each MIDI channel on and off independently when in Multi mode. This feature is helpful when you have other devices connected to the same MIDI line and do not want the XK-6 unit to respond to the MIDI channels reserved for the other devices.

MIDI ENABLE
channel 01: On

Because the MIDI Enable function only makes sense if you are in Multi mode, XK-6 disables this feature when in Omni or Poly mode.

In Multi
Mode

MIDI ENABLE
channel 16: On

In Omni
Mode

MIDI ENABLE
(using Omni mode)

Receive Program Change

Use this function to instruct XK-6 to utilize or ignore incoming MIDI preset changes or Bank Select commands for each channel. Use the cursor buttons to select the channel number field, then use the data entry control to select a channel number. Use the cursor button again to select the On/Off field and the data entry control to change the value.

RECEIVE PROGRAM CHANGE
channel 01 : on

MIDI Program Change -> Preset

You can also remap incoming MIDI program changes to a different numbered preset. This is a handy feature when your master keyboard cannot send a bank change or you want to reorder preset numbers. Any preset can be mapped to any incoming MIDI program change number.

For example, you could set up the Program -> Preset map to call up preset #12 whenever XK-6 receives MIDI program change #26.

The four fields shown below are editable.

 *The Program->Preset
Change only works for program
changes received in Bank 0.*

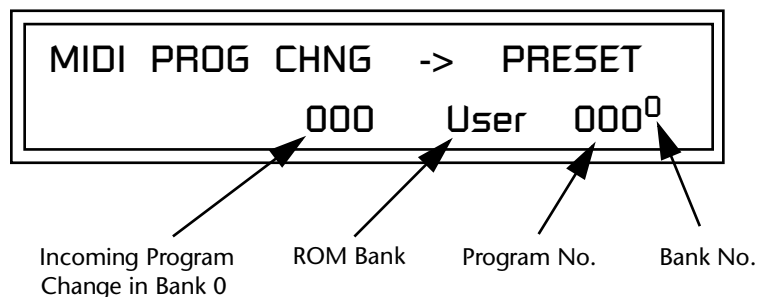

 Programs and presets are the same thing. "Preset" is the E-MU term for MIDI Program.

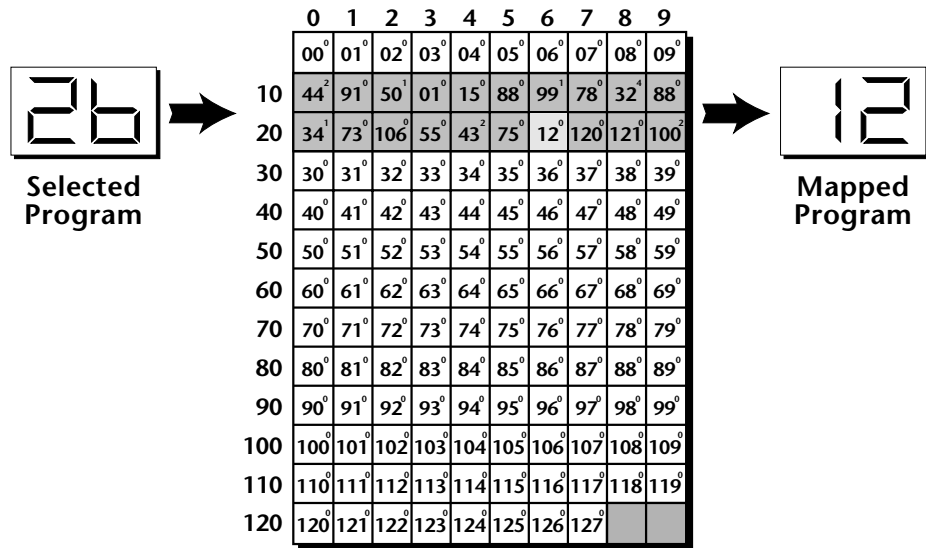

In this chart, program changes 10-29 have been remapped to new preset numbers. All other presets are selected normally.

MIDI SysEx ID

 **WARNING:** When transferring SysEx data from one XK-6 to another, the ID numbers of both units must be the same.

This page defines the MIDI system exclusive (SysEx) device ID number. The SysEx ID lets an external programming unit to distinguish between multiple XK-6 units connected to the same preset editor. In this case each unit must have a unique SysEx ID number.

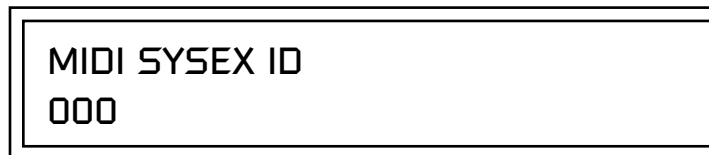

MIDI SysEx Packet Delay

The MIDI SysEx Packet Delay command lets you specify the amount of delay between MIDI SysEx packets going out of XK-6 so that your computer sequencer can record this large chunk of data over a longer period of time. On playback from the sequencer, the SysEx data will be fed more slowly into XK-6 so that its input buffer does not overflow, causing an error. Many sequencers allow you to “Time Stamp” SysEx data as it is recorded. This is the preferred mode for recording SysEx data.

The packet delay range is from 0 through 8000 milliseconds. A delay value of zero allows full speed MIDI transfer. If you are experiencing data transmission errors, try increasing the delay value until the problem disappears.

MIDI SYSEX PACKET DELAY
300 milliseconds

Send MIDI System Exclusive Data

This command transmits MIDI System Exclusive (SysEx) data to the MIDI Out port of XK-6. The MIDI data can be sent to a computer, sequencer or to another XK-6. When transferring data between two XK-6's be sure both units have the same SysEx ID number! Using the cursor key and the data entry control, select the type of MIDI data you want to transmit. Following are descriptions of the types of MIDI data that can be transmitted.

Current Multisetup

Transmits all parameters in the Global menu except Tuning Tables, Program/Preset Map and Viewing Angle. Transmits the entire Controllers menu.

Program /Preset Map

Transmits the MIDI Program -> Preset Map.

Tuning Tables

Transmits all 12 user User Tuning Tables.

Bank 0 User Presets

Transmits all the user defined presets in Bank 0.

Bank 1 User Presets

Transmits all the user defined presets in Bank 1.

Bank 2 User Presets

Transmits all the user defined presets in Bank 2.

Bank 3 User Presets

Transmits all the user defined presets in Bank 3.

Any Individual Preset

Transmits only the selected preset.



WARNING: When transferring SysEx data from one XK-6 to another, the ID numbers of both units must match.

The Enter LED will be flashing. Press the Enter button to confirm the operation. To receive MIDI data, simply send the MIDI data into XK-6 from another XK-6 or from a computer/sequencer.

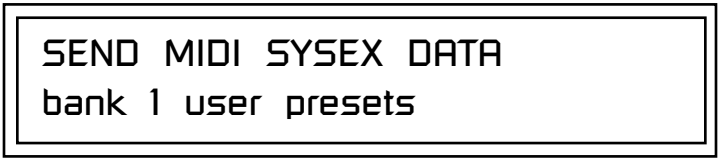

► **To Record MIDI SysEx Data into an External Sequencer:**

1. Setup the sequencer to receive system exclusive data.
2. Place the sequencer into record mode, then Send MIDI Data.

► **To Receive MIDI SysEx Data from an External Sequencer:**

Simply play back the sequence containing the SysEx data into XK-6.

MIDI Mode

MIDI Mode selects one of the three MIDI modes: Omni, Poly or Multi.

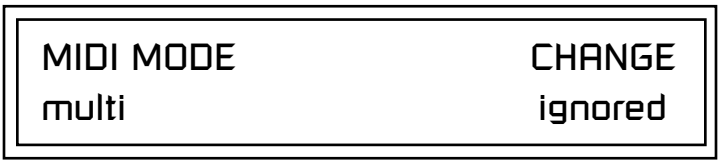

The **MIDI Mode Change** parameter specifies whether mode changes made through an external MIDI controller are accepted or ignored.

The MIDI modes are as follows:

Omni

Responds to note information on all MIDI channels and plays the preset currently displayed in the main screen.

Poly

Responds only to note information received on the currently selected MIDI channel (on the preset selection screen) and plays that channel's associated preset.

Multi

Responds to data on any combination of MIDI channels and plays the specific preset associated with each of the MIDI channels. You must select multi mode for multitimbral operation.

Programming Basics

This chapter explains how XK-6 sounds are constructed and contains important background information on how to create your own custom presets.

Your initial involvement with XK-6 will most likely be using the existing presets and selecting MIDI channels. While the factory presets are very good, there are some things you will probably want to change eventually, perhaps the LFO speed, the filter frequency or the attack time. You may also want to make your own custom presets using complex modulation routings. This module will do far more than you ever imagined and there are whole new classes of sound just waiting to be discovered.

Each preset can consist of up to four instrument layers. Each of the four layers can be placed anywhere on the keyboard and can be crossfaded or switched according to key position, velocity, or by using a real-time control such as a wheel, slider, pedal, LFO or envelope generator. A preset can also be “linked” with up to 2 more presets creating additional layering or splits.

XK-6 has an extensive modulation implementation using two multi-wave LFO's (Low Frequency Oscillators), three multi-stage envelope generators and the ability to respond to multiple MIDI controllers. You can simultaneously route any combination of these control sources to multiple destinations.

There are 512 user locations (USER Banks 0-3) available to store your own creations or edited factory presets. It's easy and fun to edit or create your own unique presets.

Modulation

To modulate means to dynamically change a parameter, whether it be the volume (amplitude modulation), the pitch (frequency modulation), and so on. Turning the volume control on your home stereo rapidly back and forth is an example of amplitude modulation. To modulate something we need a modulation source and a modulation destination. In this case, the source is your hand turning the knob, and the destination is the volume control. If we had a device that could turn the volume control automatically, we would call that device a modulation source.

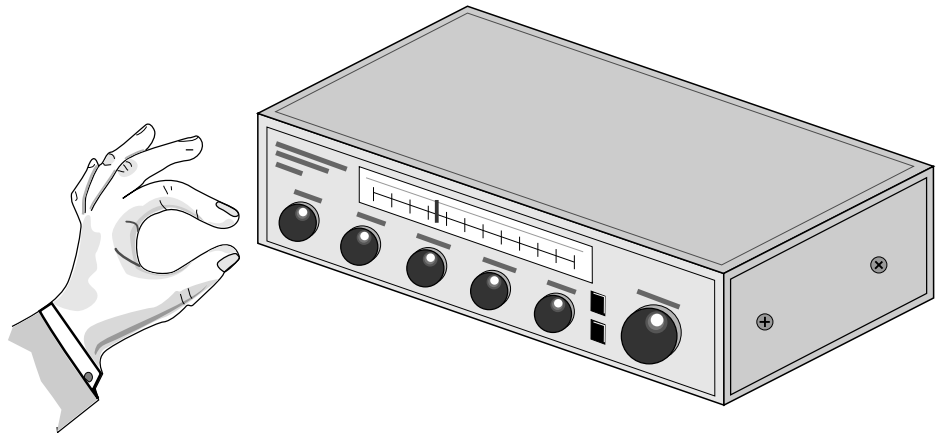

Turning the volume control back and forth on your home stereo is an example of Amplitude Modulation.

XK-6 is designed so that each of the variable parameters, such as the volume, has an initial setting which is changed by a modulation source. Therefore in the case of volume, we have an initial volume that we can change or modulate with a modulation source.

Two main kinds of modulation sources on XK-6 are *Envelope Generators* and *Low Frequency Oscillators*. In the example above, an envelope generator could be routed to automatically turn the volume control as programmed by the envelope. Or, a low frequency oscillator could be routed to turn the volume up and down in a repeating fashion.

Positive modulation adds to the initial amount. Negative modulation subtracts from the initial amount.

Summing Nodes

All the modulation inputs on XK-6 are summing nodes. This means that you can connect as many modulation sources as you want to an input (*such as Pitch or AmpVol*). Modulation sources are simply added algebraically—connecting two knobs one set to -100 and the other set to +100 yields a net value of zero.

Modulation Sources



Tip: Try routing *Key Glide* to *Filter Frequency* if you want the filter to smoothly follow pitch in solo mode. Routing *Key Glide* to *Pan* creates another interesting effect.

Modulation sources include *Envelope Generators*, *Performance Controllers* and *Low Frequency Oscillators*. In the previous example, an envelope generator was routed to automatically turn the volume control as programmed by the envelope, or, a low frequency oscillator could be routed to turn the volume control up and down in a repeating fashion. The following is a list of the modulation sources used in XK-6.

Keyboard Key

Which key is pressed.

Key Velocity

How fast the key is pressed.

Release Velocity

How fast the key is released.

Gate

High if the key is pressed, low when the key is released.

Key Glide

A smoothly changing control source based on the *Glide Rate* and the interval between the last two notes played.

Pitch and Mod Controllers

Synthesizer pitch bend and modulation controllers.

Keyboard Pressure (mono aftertouch)

Key Pressure applied after the keyboard key is initially pressed.

Pedal

A continuously variable pedal controller.

Miscellaneous Controllers A -P

Any type of MIDI continuous controller data.

Low Frequency Oscillators (2 per layer)

Generate repeating waves.

Envelope Generators (3 per layer)

Generate a programmable “contour” which changes over time when a key is pressed.

Noise & Random Generators

Generate spectrums of noise and random signals.

Footswitches

Change a parameter when the switch is pressed.

Clock Divisor

The master tempo clock can be divided and used as a modulation source.

Random Sources

Random modulation sources can be used when you want the timbre of the sound to be “animated” in a random or non-consistent manner.

- **Key Random 1 & 2** generate different random values for each layer which do not change during the note.
- The **White & Pink Noise** Generators produce varying random values. Both white and pink noise sources are low frequency noise designed for control purposes. Either noise source can be filtered even more by passing it through a lag processor.
- The **Crossfade Random** function generates the same random value for all layers in a preset. This source is designed to be used for cross-fading and cross-switching layers, although you may find other uses.

Modulation PatchCords

 The controller Knobs assignments printed on the front panel are the system defaults. You can change any of these assignments using the Real-time Controller Assignment page in the MIDI menu (see page 94 for details).

When setting up modulation with the XK-6, you define a modulation source and a modulation destination. Then, you connect the source to the destination using “PatchCords.” XK-6’s PatchCords are connected in the software. XK-6 has 24 general purpose PatchCords for each layer.

You can connect the modulation sources in almost any possible way to the modulation destinations. You can even modulate other modulators. Each PatchCord also has an amount parameter which determines “how much” modulation is applied to the destination. The modulation amount can be positive or negative. Negative values invert the modulation source.

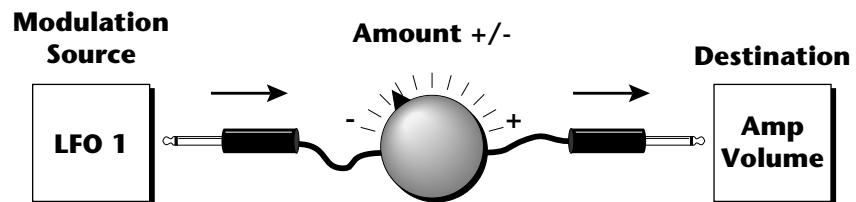

Envelope Generators



If two adjacent segments have the same level in a “time-based” envelope, the segment will be skipped. Adjacent segments must have different levels for the rate control to work.



ADSR mode: To create a standard ADSR envelope: Set *Atk1*, *Atk2* & *Dcy1* Level to 100, *Rls 1* & *2* level to 0, and *Atk2*, *Dcy1*, *Rls2* Rates to 0. Program *Atk1*, *Dcy2* and *Rls1* segments as you wish. See page 201.



By routing the Auxiliary or Filter Envelopes to control the pitch (*PatchCords*) you can easily hear the shape of the envelopes you are creating.

An envelope can be described as a “contour” which is used to shape the sound over time in a pre-programmed manner. There are three envelope generators per layer and all of them are the rate/level type.

This is how the rate/level (*time based*) envelopes work: When a key is pressed, envelope starts from zero and moves toward the Attack 1 Level at the Attack 1 Rate. As soon as it reaches this first level, it immediately begins the next phase and moves toward the Attack 2 level at the Attack 2 rate. As long as the key is held down, the envelope continues on through the Decay 1 and Decay 2 stages. If the key is still held when the envelope reaches the end of Decay 2, it simply waits there for you to release the key. When you release the key, the envelope continues into the Release 1 and Release 2 stages, stopping at the end of the Release 2 stage. XK-6’s envelope generators provide great flexibility for programming both complex and simple envelopes.

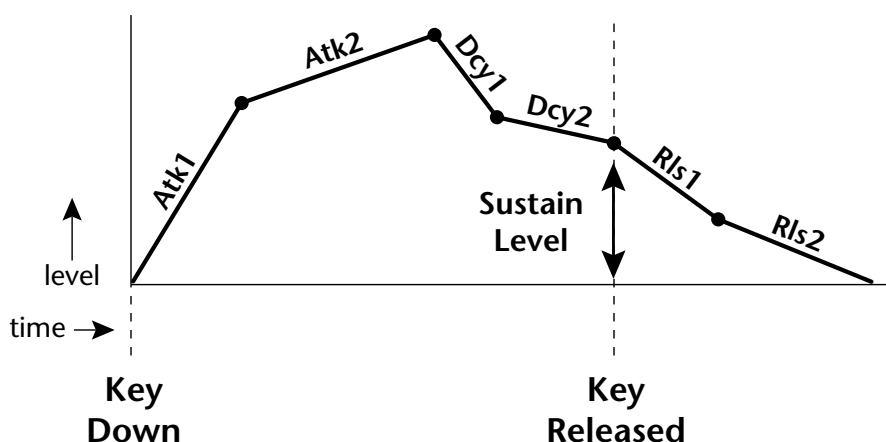

All three envelope generators have the six stages described above. The Volume Envelope generator controls the volume of the voice over time. The Filter Envelope generator is a general purpose envelope most often used to control the filter frequency. Unlike the Volume Envelope, however, the Filter Envelope can have a negative level value as well as a positive level. There is also an Auxiliary Envelope generator which is a general purpose envelope. The Auxiliary Envelope is identical to the Filter Envelope and can have negative as well as positive levels. You can adjust the time of each stage to create myriad envelope shapes, which in turn shape the sound over time.

- Volume envelopes contour the way the volume of a sound changes over time determining how we perceive that sound. For example, a bell struck with a hammer is instantly at full volume, then slowly dies away. A bowed violin sound fades in more slowly and dies away slowly. Using XK-6’s Volume Envelope, you can simulate the different types of natural instrument volume envelopes by programming them appropriately.

Tempo-based Envelopes

Tempo-based envelopes are based on *Time* which is controlled by the Master Tempo (*located in the Global menu*). The Master Tempo rate scales the time of the Tempo-based envelope segments. The Master Tempo can be set to use an external MIDI clock so that the envelope times can be synchronized to external sequencer or arpeggiator tempo changes. See page 82.

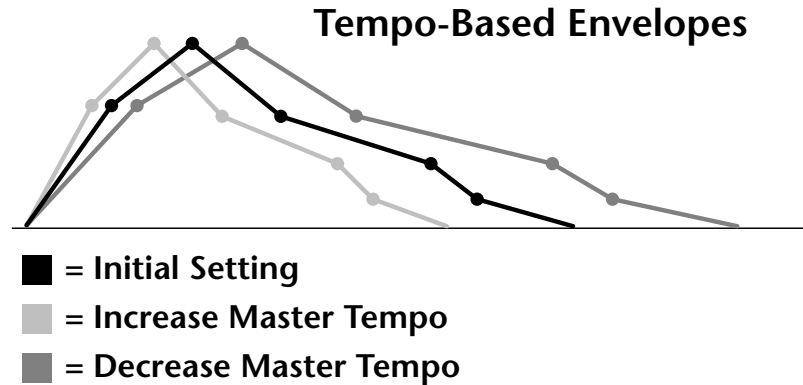

Envelope Repeat

The Envelope Generators can also be made to repeat. When the envelope repeat function is On, the Attack (1&2) and Decay (1&2) stages will continue to repeat as long as the key is held. As soon as the key is released, the envelope continues through its normal Release stages (1 & 2).

 Only the Filter and Auxiliary Envelopes have the repeating feature.

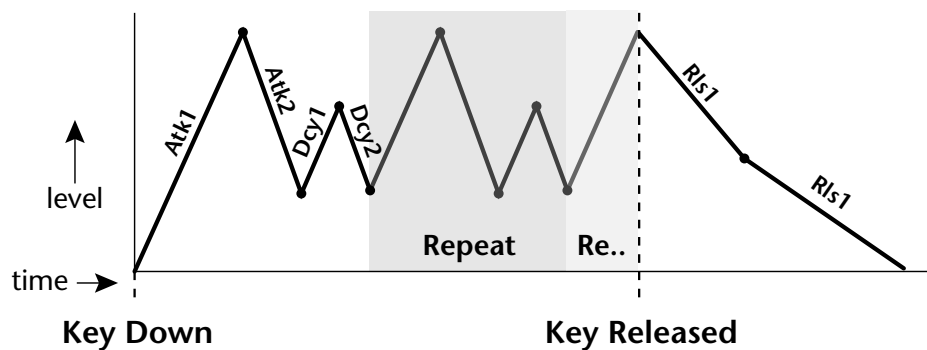

The diagram above show how the looping envelopes work. When the key is pressed the envelope goes through its regular Attack 1, Attack 2, Decay 1 and Decay 2 stages. In non-looping mode, the envelope would hold at the end of the Decay 2 stage until the key was released. In looping mode however, it jumps back to the Attack 1 stage and repeats the first four stages. It continues to loop through these four stages until the key is released where it immediately jumps to the Release 1 stage.

Low Frequency Oscillators (LFOs)

LFO Tricks & Tips:

- The Random LFO wave is truly random and is different for each voice and layer.
- The Pattern (Pat) waveforms will sound the same on different layers and voices.
- Sine + Noise is very useful for simulating trumpet and flute vibrato.

★ When routing Hemi-quaver to Pitch:

- +38 = major scale
- 38 = phrygian scale
- +76 = whole tone scale
- (+38) + (+76) = diminished (two cords)
- odd amount = S+H sound

Note: References to musical intervals in the pattern LFO shapes are with the LFO routed to pitch and a PatchCord amount of +38.

 Try combining the Pattern LFOs, or controlling the amount of one with another, or combining them with the clock divisors.

A Low Frequency Oscillator or LFO is simply a wave which repeats at a slow rate. The XK-6 has two multi-wave LFOs for each channel. The LFO waveforms are shown in the following illustration.

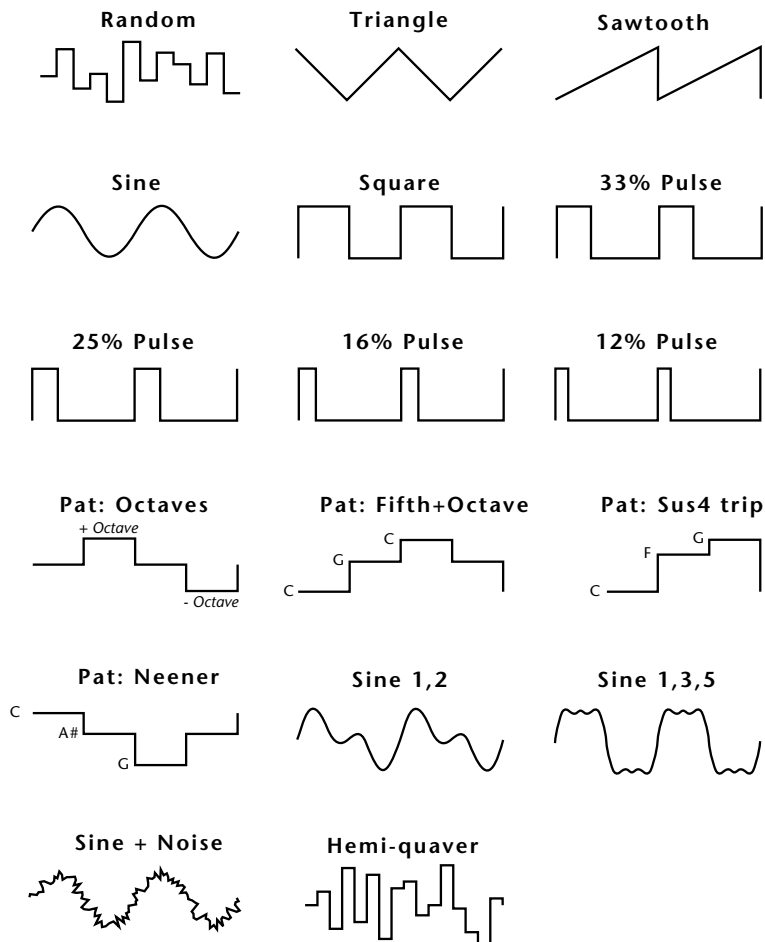

By examining the diagram of the LFO waveforms, you can see how an LFO affects a modulation destination. The shape of the waveform determines the result. Suppose we are modulating the pitch of an instrument. The sine wave looks smooth, and changes the pitch smoothly. The square wave changes abruptly and abruptly changes from one pitch to another. The sawtooth wave increases smoothly, then changes back abruptly. The sound's pitch follows the same course. Controlling the pitch of an instrument is an easy way to hear the effects of the LFO waves.

Like the Auxiliary Envelope, LFOs can be routed to control any real-time function such as Pitch, Filter, Panning, or Volume. A common use for the LFO is to control the pitch of the sound (LFO -> Pitch). This effect is called vibrato and is an important performance effect. Many presets use this routing with the modulation wheel controlling "how much" LFO modulation is applied. Another common effect, Tremolo, is created by controlling the volume of a sound with the LFO (LFO -> Volume).

You might use the LFOs to add a slight bit of animation to the sound by routing the LFO to control the filter. For this effect, set the LFO “amount” low for a subtle effect.

When a PatchCord amount is a negative value, the LFO shape is inverted. For example, inverting the sawtooth wave produces a wave that increases abruptly, then smoothly glides down.

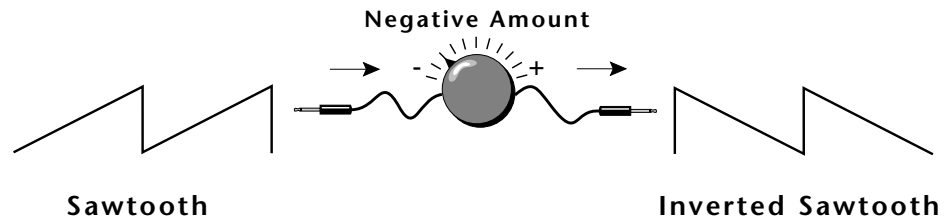

Clock Modulation

 Envelopes are triggered on the positive going edge of the clock. LFOs are triggered on the negative going edge of the clock.

 The tempo of the master clock is set in the Global menu.

You can use the Master Clock as a modulation source, to trigger the Filter or Auxiliary Envelope generators, trigger Sample Start, synchronize the LFOs, or directly as a square wave modulation source. The Clock source is available in eight divisions (octal whole note, quad whole note, double whole note, whole note, half note, quarter note, eighth note, sixteenth note). You can use the different rates separately or in conjunction to create complex “synchro-sonic” rhythm patterns. You can also use a MIDI Clock as the Master Clock to synchronize to an external MIDI device such as a drum machine or sequencer. (See *Master Tempo* in the *Global* menu.)

Clocks are routed exactly like the other modulations sources using the PatchCords. The PatchCord Amount MUST be positive (+) for the clock to pass. By modulating the PatchCord Amount, you can route the divided clocks using real-time controllers or other modulation sources.

When an LFO is triggered by a clock, the LFO wave resets to zero every time the clock wave goes low. If the LFO rate is close to the clock rate, the LFO virtually synchronizes with the clock. If the two rates are far apart, the waveform of the LFO will be mildly or radically altered.

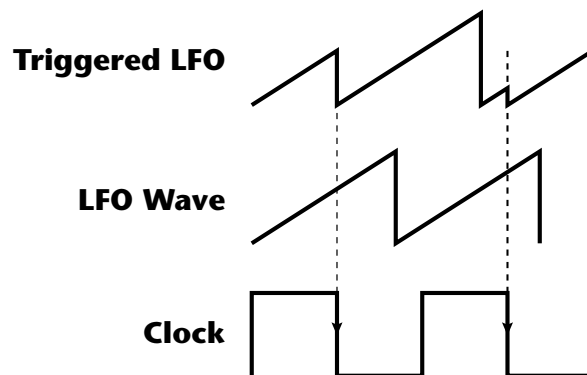

LFO Trigger causes the LFO to reset each time the clock waveform goes low.



LFO Synced to 1/4 Note Clock

LFOs can also be perfectly synchronized with the clock at any of 25 note divisions. This allows you to create very cool “synchro-sonic” effects that work perfectly at any tempo. Choosing one of the note divisors in the LFO rate screen selects the synced LFO function.

There are many possibilities for clock modulation and retrigger. For example, you can create a repeating six segment curve of any shape by triggering the Filter or Auxiliary Envelope generators with the clock. A few other possibilities are listed below.

- Turn different voice layers on and off using different clock divisors.
- Switch between Auxiliary and Filter Envelope retriggering using a slider or footswitch.
- Retrigger LFOs or Envelopes using noise or other LFOs to create random or semi random effects.
- Alter the LFO waveform by modulating the rate of a triggered LFO.
- Route multiple clocks with different divisors to the same destination (such as pitch) to create complex patterns. (*Hint: Adjust the PatchCord Amounts.*)

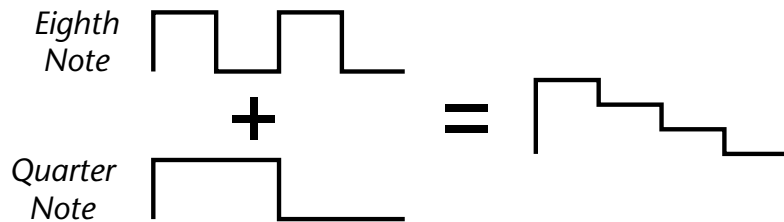

Adding these two clocks together in equal amounts produces a stairstep waveform.

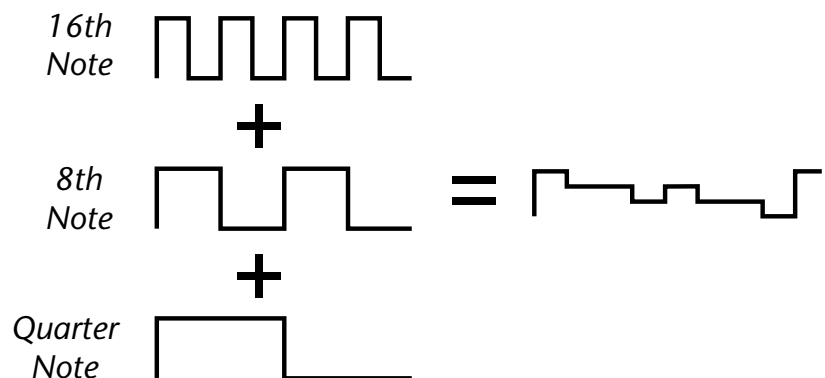

Adding multiple clocks with unequal amounts produces complex repeating patterns.

Modulation Destinations

The PatchCords section of the Preset Edit menu is where you connect sources to destinations. Each PatchCord has an amount associated with it which controls how much modulation is applied.

L1	PATCHCORD	#01
	ModWhl ->	RTXfade +036

The PatchCords screen above and the diagram below show how modulation sources are connected to destinations. The modulation sources can control any of the destinations in the layer.

 All the modulation destinations are summing nodes. This means that you can connect as many modulation sources as you want to a destination. Modulation sources are simply added algebraically — connecting two sources, one with a value of -100 and the other with a value of +100 yields a net value of zero.

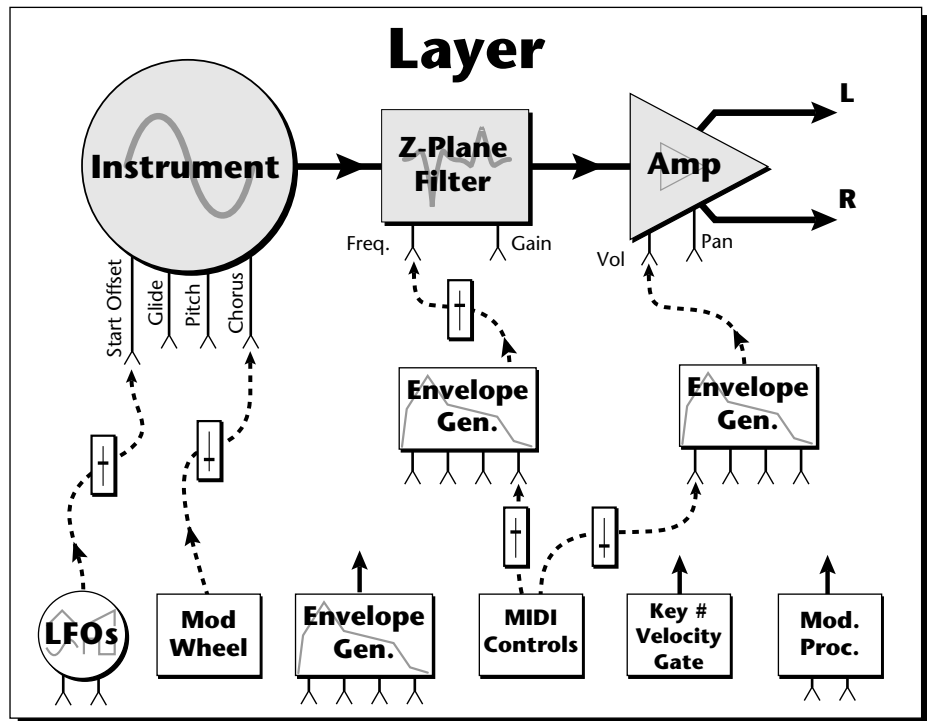

- Note-on modulation sources, such as key, velocity and gate output a single value at note-on time. Realtime modulation sources such as LFOs, envelope generators and modulation wheels output continuously changing values.

The possible modulation routings are completely flexible as shown in the diagram above. Multiple sources can control the same destination, or a single source can control multiple destinations.

Modulation Processors

Modulation processors are devices which can modify modulation sources such as LFOs and envelope generators before they are applied to a destination. Modulation processors let you create patches and do tricks which would not be possible otherwise. These modulation processors are independently programmable on each of the four layers.

Switch

Outputs a digital “1” when the input is greater than “0”.

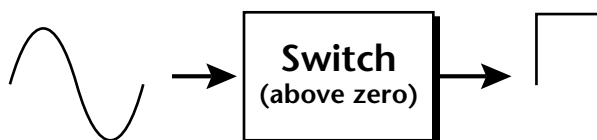

Summing Amp

Lets you add several modulation signals together before applying them to a destination. This processor can save PatchCords when routing the output to multiple destinations.

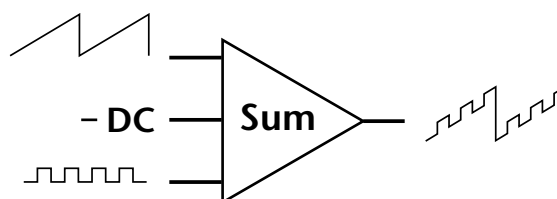

Lag Processors

Slows down rapid changes in the input signal. The output “lags” behind the input at a pre-programmed rate. There are two lag processors, Lag 0 and Lag 1. Lag 1 has a longer lag time than Lag 0.

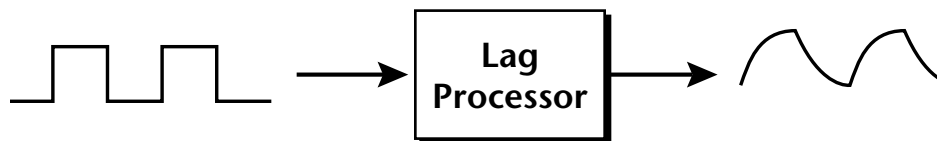

Absolute Value

This function inverts negative input values and outputs only positive values. This device is also called a full wave rectifier.

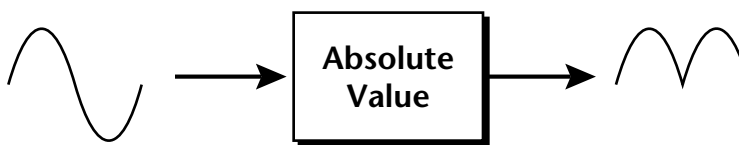

Diode

The diode blocks negative input values, passing only positive values.

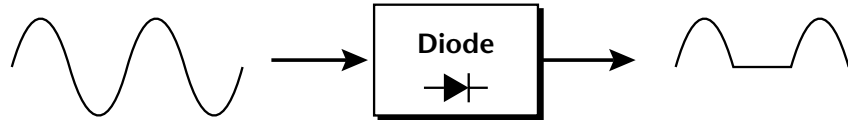

Flip-Flop

The output of this processor alternates between a digital "1" and digital "0" each time the input goes positive from zero or a negative value. With an LFO input, the output will be a square wave of half the input frequency.



 The value of a digital "1" is equal to the PatchCord amount.

Quantizer

With the input PatchCord set to 100%, the output value is limited to 16 discrete values. The value of the input PatchCord controls the number of steps. The value of the output PatchCord controls the size of the steps.

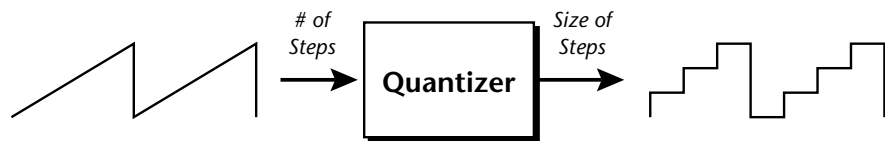

4x Gain

This processor amplifies the modulation source by a factor of 4.

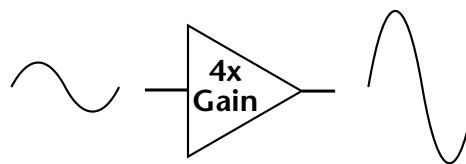

 Summing Amps can be useful in complicated patches where you want to control a combination of modulation signals with a single patchcord.

Lag Inputs

The Lag processors can be used as 2 additional summing amps. Lag0sum and Lag1sum are modulation sources which equal the sum of PatchCords connected to the Lag in destination. The summing amp is located before the lag processor as shown in the following illustration.

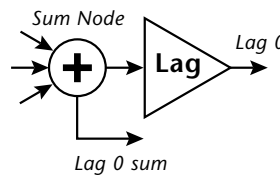

Preset Modulation Processors



Preset Modulation Processors start working as soon as the preset is selected. The Layer Modulation Processors take effect only when a key is pressed.

There are also two “Preset Level” modulation processors located in the “Preset Patchcords” screen of the Edit menu. It is important to understand that although the preset processors *originate* at the *Preset Level PatchCords*, their output is used in the *Layer PatchCords*.

Preset Lag

Like the Layer Lag processors (*described on page 109*) the Preset Lag slows down rapid changes in the input signal. The output “lags” behind the input at a pre-programmed rate. Unlike the layer level lag processors, the *preset lag* takes effect as soon as the preset is selected. In contrast, the layer level lag processors begin acting only after a keyboard key has been depressed. The Preset Lag also has a *Lag Amount* input which controls the lag time. Positive lag amounts increase the lag time. A MIDI controller (*front panel knob*) is commonly used to control lag amount.

The preset lag can be used to “spin-up” and “spin-down” an LFO which controls some other effect, perhaps left/right panning, pitch, or the filter. A MIDI footswitch could be used as the input to the lag which acts to slow down the instantaneous change of the switch. The slowly changing output value is then routed using a layer patchcord to crossfade between layers or change the speed of an LFO.

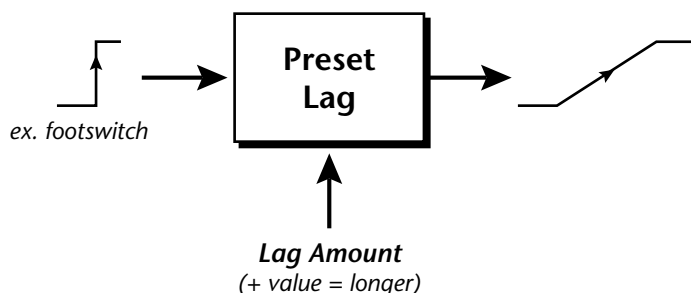

Preset Ramp

This processor generates a positive or negative going slope whenever the **first** key is depressed on the MIDI channel.

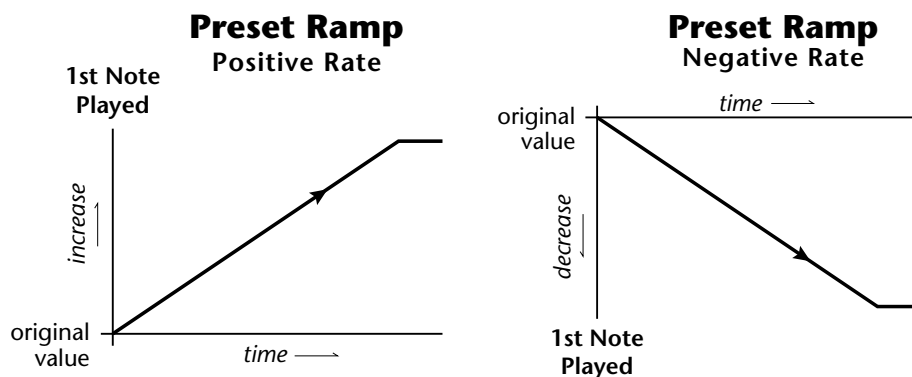

The preset ramp instantly resets when all notes have been released and the next *first key* on the MIDI channel is pressed. The Ramp Rate polarity (+ or -) determines if the ramp will be positive or negative going. The value of the ramp rate sets the increment. Large values produce fast ramps and small values produce slow ramps. Multiple inputs can be connected to the ramp rate (just like all the other destinations in XK-6).

The patch below shows an application for the Preset Ramp which generates an adjustable decay envelope ONLY on the first note played to bring in the sound from another layer. Instead of routing the output to the Amp Volume you could just as easily route it to control Pitch, LFO Speed or any other destination you can think of. Study this patch if you want to learn a few new tricks using the patchcords.

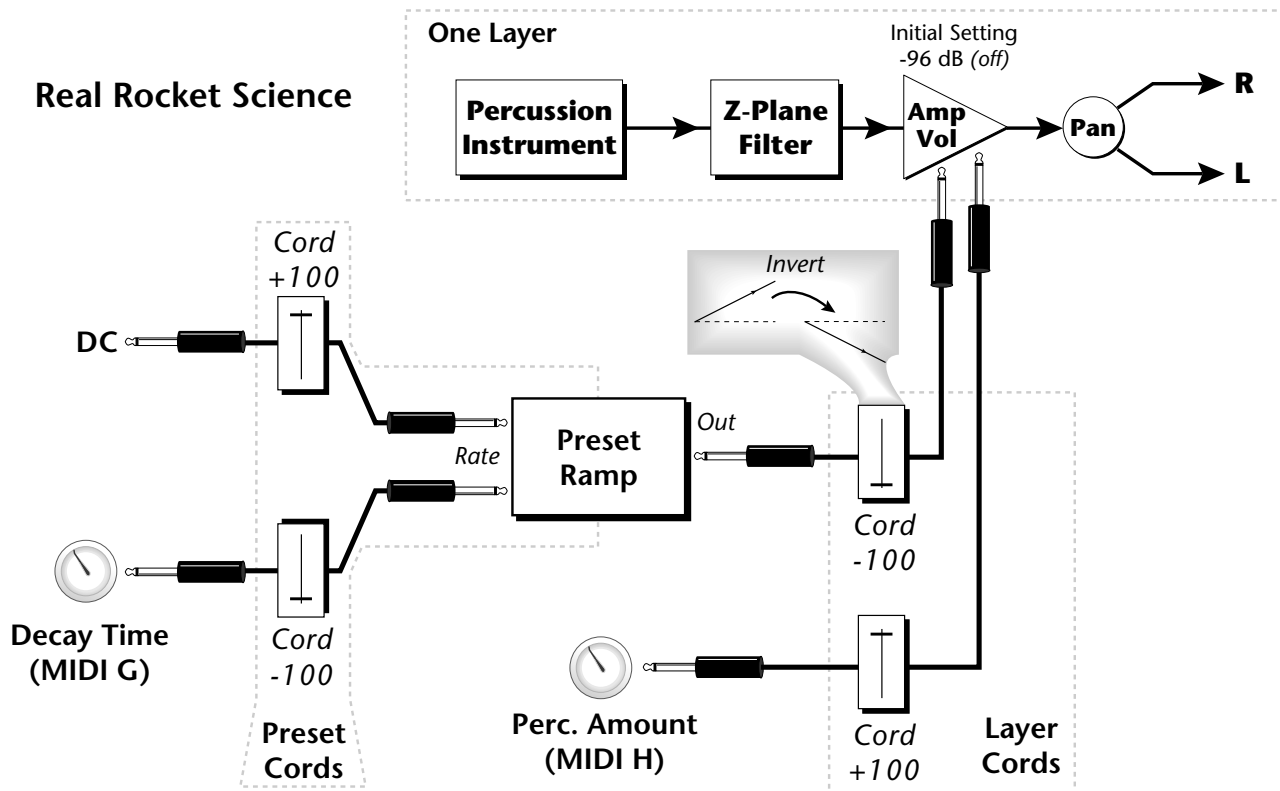

 The combination of the DC & Perc. Decay Time Cords has the effect of reversing the Percussion Decay Time knob. The decay time increases as the knob is turned up.

1. DC - Sets initial ramp Fast-Positive (+100)
2. Decay Knob - Inverted value slows ramp as the knob value is increased.
3. Ramp Out Cord - Inverts Ramp slope (downward).
4. Amp Vol - Initial setting is Off (-96dB). Ramp cannot overcome this negative bias.
5. Perc. Amt - When this knob is turned up, the positive bias on the Amp is restored so that so that the Ramp can now affect Amp Volume.
6. Volume Envelope - Fast Attack, Full Sustain, No Release

Using the Modulation Processors

Modulation processors are inserted into a modulation routing as shown in the following diagram.

The modular analog synthesizers of yesteryear were incredibly flexible, partly because processing devices could be connected in any order. Modulation processors are designed according to this modular concept. They can be linked and used in a wide variety of ways limited only by your imagination. Consider the following example:

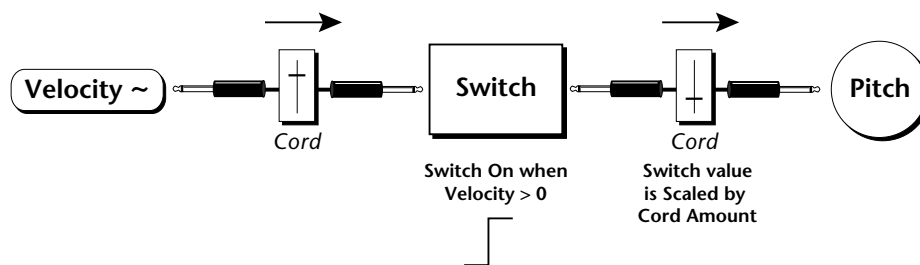

The patch illustrated above is programmed by setting the PatchCord screens as shown below.

L1 PATCHCORD	#01
Vel+- -> Switch	+100

L1 PATCHCORD	#02
Switch -> Pitch	+022

This particular modulation shifts the overall pitch up a fifth when the key velocity exceeds 64. Velocities below 64 play at normal pitch. Notes with velocities of 64 and above are raised a perfect fifth. The Velocity “~” source scales the played velocity around zero. In other words, low velocities (below 64) will have negative values and high velocities (64 and above) will be positive. A velocity of 64 would be zero. The Switch module only outputs a “1” if the input value is greater than zero. This digital “1” value can be scaled through the attenuator on the PatchCord to raise or lower the pitch by any amount. In this case, a scaling value of +22 raises the pitch by a perfect fifth. The amount of the PatchCord on the input to the switch is unimportant because ANY velocity value equal or greater than 64 will flip the switch. If the input PatchCord amount were a negative value however, the action of the velocity would be reversed and velocities less than 64 would raise the pitch and velocities equal or greater than 64 would play the original pitch.

But what if you want the velocity switch point to be something other than 64? Thanks to modulation processors, it can be done. Here's how.

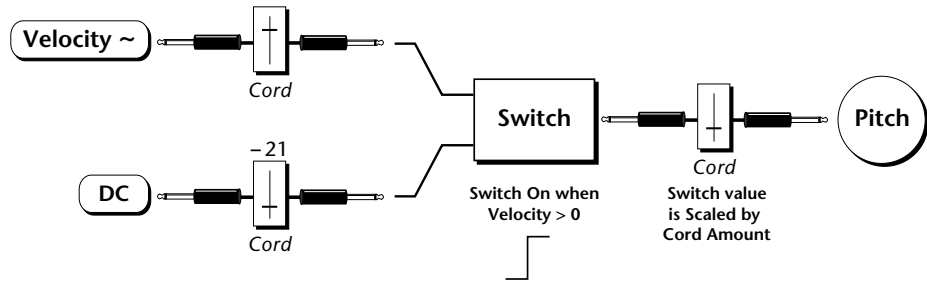

Connect the DC level to the input of the switch along with the velocity value. Note that more than one modulation source can be applied to the input of a processor.

DC offset adds a fixed value based on the PatchCord Amount setting. If applied to the switch along with the velocity, it changes the velocity value required to trip the switch. By setting the DC amount to a negative amount, higher velocity values are required to trip the switch. Setting the DC value to a positive value would bring the velocity switch point down. The PatchCord screens for this patch are shown below.

L1 PATCHCORD	#01
Vel+- -> Switch	+100

L1 PATCHCORD	#02
DC -> Switch	-021

L1 PATCHCORD	#03
Switch -> Pitch	+022

More Examples

To derive a smooth random function you could route the Pink Noise generator through one of the Lag Processors. A smooth random wave is useful in small amounts to add a degree of natural variation to timbre when routed to filter cutoff. Normal pink noise is low pass filtered audio frequency noise with a 3 dB/octave slope to give equal energy per octave. XK-6 pink noise is actually more like very low frequency filtered noise, but it is perfect for use as a random control source.

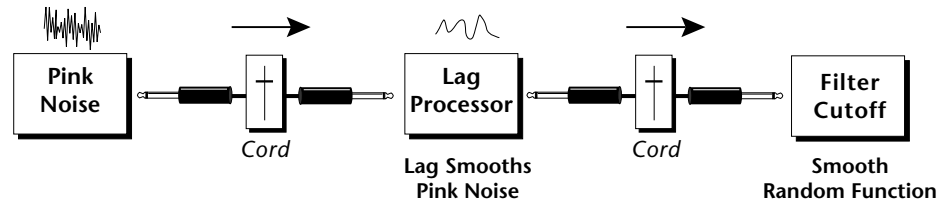

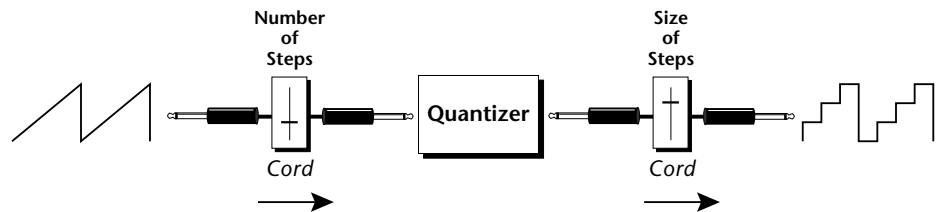

The **Quantizer** can generate interesting whole-tone scales when envelope generators or LFOs are routed to the input. The quantizer turns a smoothly changing input signal into a series of steps. By routing the output of the quantizer to Pitch and adjusting the PatchCord amounts, you can control both the number of steps and the pitch interval of each step.

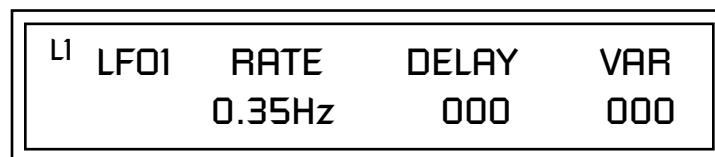
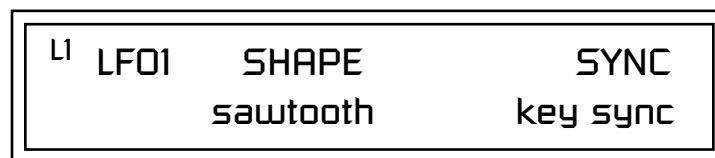

The input PatchCord amount controls how many steps will be generated. With a sawtooth wave (LFO+) feeding the input and the PatchCord amount set to 100%, sixteen steps are generated. The output PatchCord amount controls the size (or interval) of the steps.

Try setting up the following patch exactly as shown below using your favorite preset as a starting point.



 The 4x Amp can be used to get more steps or increase the interval of the Quantizer.

L1	PATCHCORD	#01
LFO1+	-> Quantize	+030

L1	PATCHCORD	#02
Quantize	-> Pitch	+100

L1	PATCHCORD	#03
DC	-> Pitch	-050

 Experiment with this patch by connecting other sources and destinations to the Quantizer.

This patch generates an ascending arpeggio every time a key is pressed. A diagram of the patch is shown below. The patch is very straightforward except for the DC offset which was added to bring the pitch down into tune. (Sometimes you have to fix a problem, but using the mod processors there's usually a way around it to achieve the desired result.)

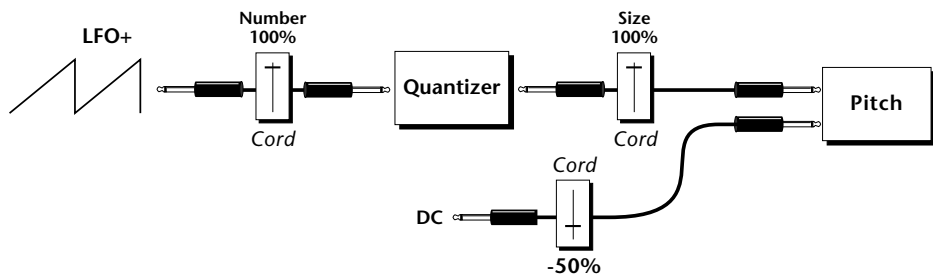

You can start to see some of the possibilities (and there are many). Whenever you find yourself wishing for some esoteric type of control, take a minute to think and see if there is a way to achieve the desired result using the modulation processors.

Dynamic Filters

The block diagram of the XK-6's signal path is shown below.

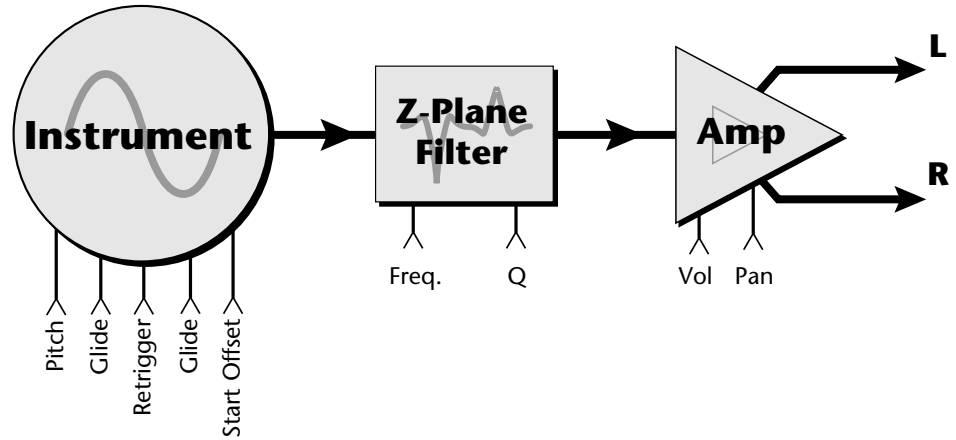

To understand how a filter works, we need to understand what makes up a sound wave. A sine wave is the simplest form of sound wave. Any waveform, except a sine wave, can be analyzed as a mix of sine waves at specific frequencies and amplitudes.

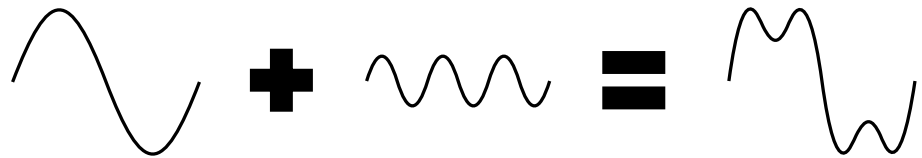

Any waveform can be analyzed as a mixture of sine waves.

One way to represent complex waveforms is to use a chart with frequency on one axis and amplitude on the other. Each vertical line of the chart represents one sine wave at a specific amplitude and frequency.

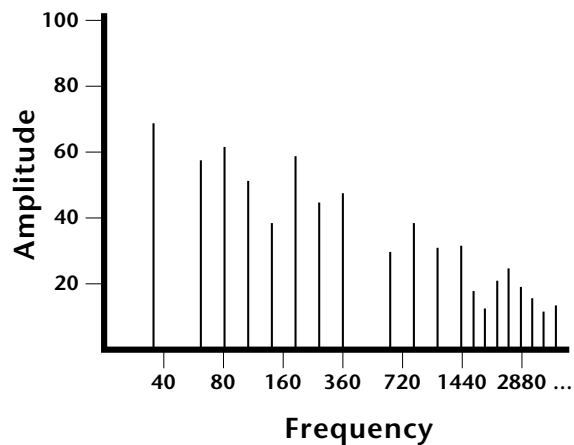

What is a Filter?

Most sounds are complex waves containing many sine waves of various amplitudes and frequencies. A **filter** is a device which allows us to **remove certain components of a sound depending on its frequency**. For example, a *low-pass filter* lets the low frequencies pass and removes only the high frequencies as illustrated in the following diagram.

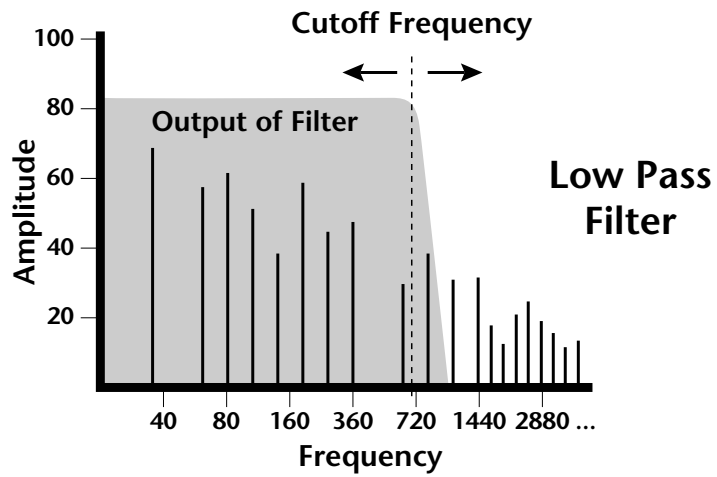

A filter that lets only the high frequencies pass is called a *high-pass filter* as illustrated in the following diagram.

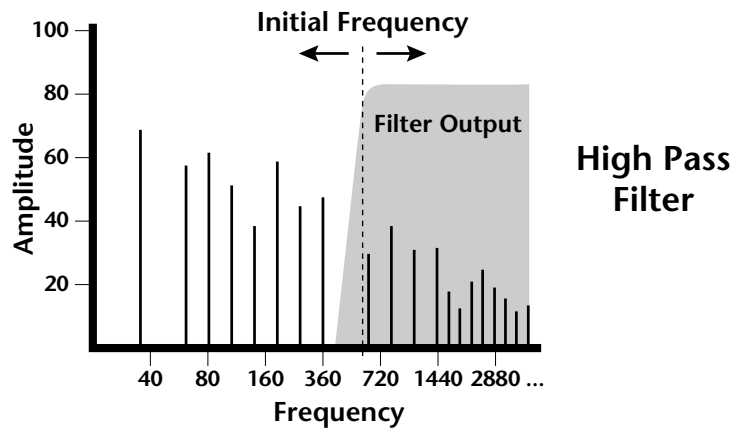

A filter which only lets a certain band of frequencies pass is called a *band-pass filter*.

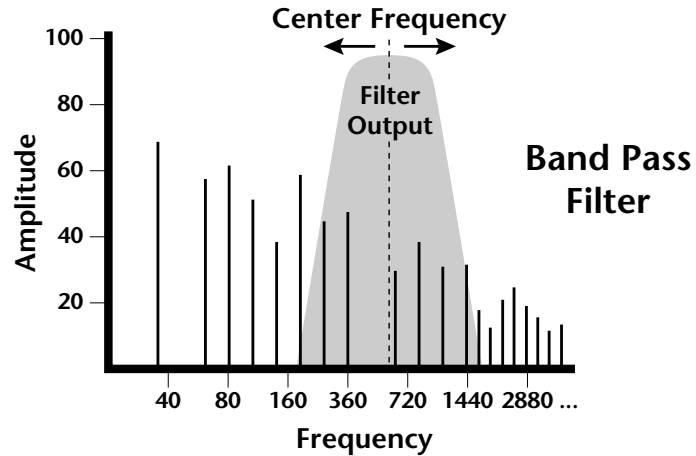

A *notch filter* is just the opposite of a band-pass filter and is used to eliminate a narrow band of frequencies.

Another control found on traditional filters is called Q or resonance. A lowpass filter with a high Q emphasizes the frequencies around the cutoff frequency. The following chart shows how different amounts of Q affect the low-pass filter response. In terms of sound, frequencies around the cutoff tend to “ring” with high Q settings. If a filter with high Q is slowly swept back and forth, various overtones are “picked out” of the sound and amplified as the resonant peak sweeps over them. Bells and gongs are real world examples of sounds which have a high Q.

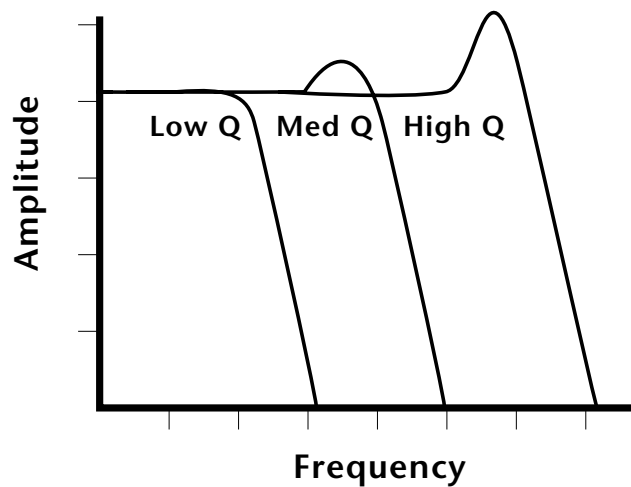

Another characteristic of a filter is the number of poles it contains. Traditional synthesizer filters were usually either 2-pole or 4-pole filters. The XK-6 has selectable 2, 4, and 6-pole low-pass filters. The number of poles in a filter describes the steepness of its slope. The more poles, the steeper the filter's slope and the stronger the filtering action. The tone controls on your home stereo are probably one-pole or two-pole filters. Parametric equalizers are usually either two-pole or three-pole filters.

In terms of vintage synthesizers, Moog and ARP synthesizers used 4-pole filters, Oberheim and E-mu synthesizers were famous for their 2-pole filter sound.

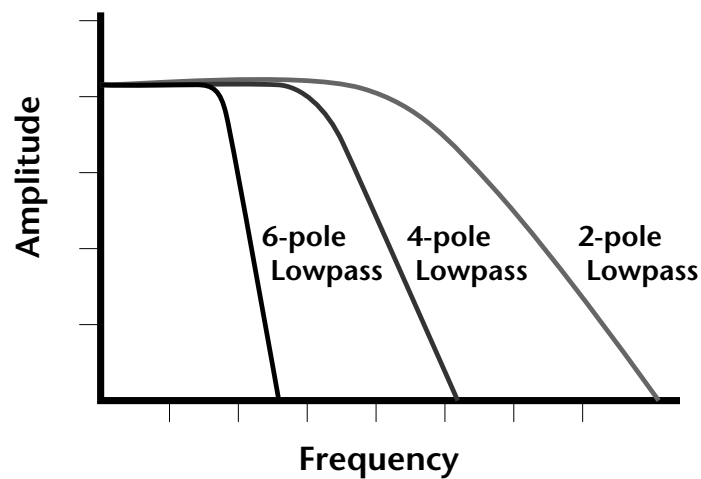

Using a filter, we have a way to control the harmonic content of a sound. As it turns out, even a simple low-pass filter can simulate the response of many natural sounds.

For example, when a piano string is struck by its hammer, there are initially a lot of high frequencies present. If the same note is played softer, there are fewer high frequencies generated by the string. We can simulate this effect by routing keyboard velocity to control the low-pass filter. The result is expressive, natural control over the sound.

If you use an envelope generator to control the cutoff frequency of a filter, the frequency content can be varied dynamically over the course of the note. This adds animation to the sound as well as simulates the response of many natural instruments.

Parametric Filters

A more complex type of filter is called a parametric filter or *Swept EQ*. A parametric filter allows control over three basic parameters of the filter. The three parameters are: *Bandwidth*, *Frequency* and *Gain*. The Bandwidth allows you to select the width of the range of frequencies to be boosted or cut, the Frequency defines the center frequency of the bandwidth, and the Gain parameter either boosts or cuts the frequencies within the selected band by a specified amount. Frequencies not included in the selected band are left unaltered. This is different from a band-pass filter which attenuates (reduces) frequencies outside the selected band.

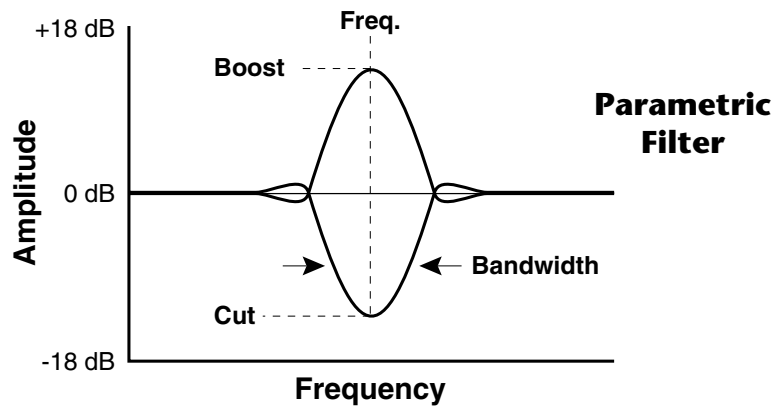

The parametric filter is quite flexible. Any range of frequencies can be either amplified or attenuated. Several parametric sections are often cascaded in order to create complex filter response curves.

If four parametric filter sections were cascaded, it would be possible to create the following complex filter response.

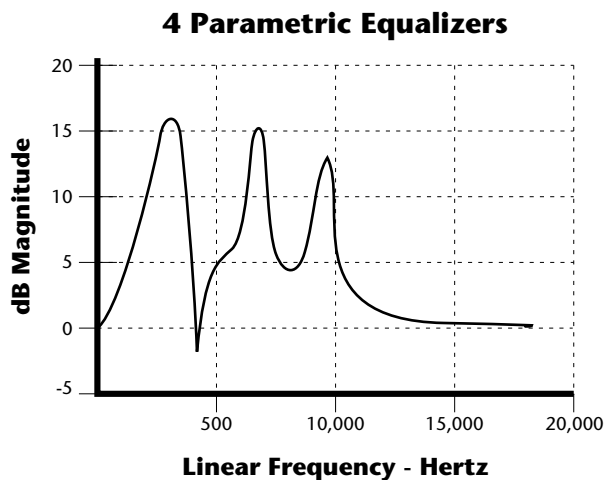

Many natural instruments have complex resonances which are based on their soundboard or tube size. The resonance shown above would be impossible to create using a normal synthesizer filter.

The Z-Plane Filter

A Z-plane filter is a filter which can change its function over time. In a Z-plane filter, we start with two complex filter types and interpolate between them using a single parameter. See the following diagram.

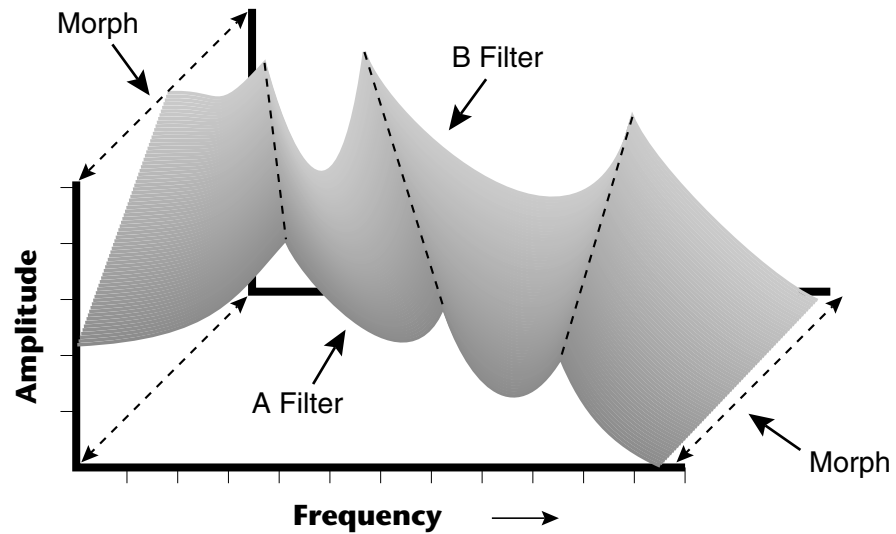

The Z-plane filter has the unique ability to change its function over time.

Filters A and B represent two different complex filters or “frames.” Changing a single parameter, the Morph, changes many complex filter parameters simultaneously. Following along the Morph axis you can see that the filter response smoothly interpolates between the two filters. This is the essence of the Z-plane filter. Through the use of interpolation, many complex parameters are condensed into one manageable entity.

Consider, as an example, the human vocal tract, which is a type of complex filter or resonator. There are dozens of different muscles controlling the shape of the vocal tract. When speaking, however, we don't think of the muscles, we just remember how it feels to form the vowels. A vowel is really a configuration of many muscles, but we consider it a single object. In changing from one vowel to another, we don't need to consider the frequencies of the resonant peaks. You remember the shape of your mouth for each sound and interpolate between them.

This Z-plane filter sweep can be controlled by an envelope generator, an LFO, modulation wheels or pedals, keyboard velocity, key pressure, and so on. In fact, any of the modulation sources can control the Z-plane filter.

Because creating the complex filtering is difficult and very time consuming, we have created 50 different filters and installed them permanently in ROM for your use. You simply select and use the filters in a manner similar to choosing an instrument. Because there are so many types of instruments and filters to choose from, the number of possible permutations is staggering.

Signal Flow

Going back to the Signal Path diagram for a single channel we can reexamine the complete signal path.

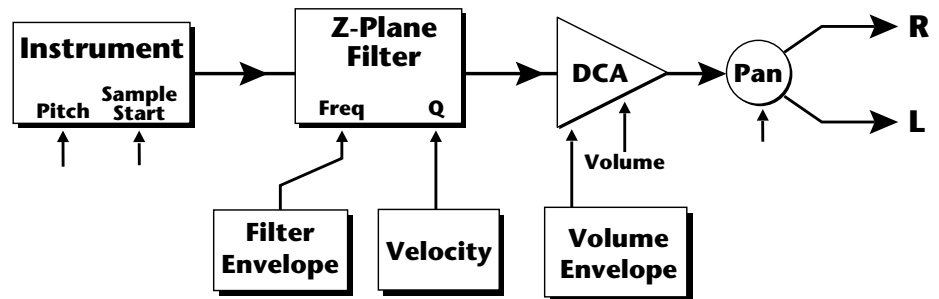

Instrument

This is the sampled sound wave. The pitch of the instrument can be modulated by any modulation source. The sample start point can be changed only at the time the note is played.

Z-Plane Filter

The Z-Plane Filter is used to shape the harmonic content of an instrument. The filter envelope is commonly used to shape the harmonic content dynamically over time but the filter frequency can be modulated by any source. The Q parameter can be modulated only at note-on time. There are 50 types of filters available. See “XK-6 Filter Types” on page 148 for a complete list of the filters.

Digitally Controlled Amplifier (DCA)

Together with the Volume Envelope, the DCA is used to shape the volume contour of a sound. The DCA can be controlled by any modulation source. Velocity is often used as a modulation source for the DCA so that the harder you play, the louder the sound becomes.

Pan

Adjusts the balance of sound to the left and right channels. Pan can be modulated by any modulation source.

MIDI Channels & Real-time Controls

 The following MIDI controls are automatically routed in XK-6:

Pitch Wheel	pwh
Modulation Wheel	01
Pedal	04
Volume	07
Pan	10
Expression	11

The MIDI real-time controllers may seem confusing at first, but they are really very simple once you understand them. You already know that there are 16 MIDI channels per MIDI cable. Each MIDI channel uses three basic types of messages; note on/off, preset changes, and continuous controller messages. XK-6 can also send real-time control information, which simply means control occurring in real-time or “live.” Real-time control sources include such things as controller knobs, pitch wheels, modulation wheels, control pedals and aftertouch. These are used to add more expression or control.

The front panel control knobs send out real-time controller information on separate continuous controller numbers. There is a set of 32 continuous controller numbers for each MIDI channel. Some continuous controllers, such as modulation wheel, volume, and pan have standardized numbers. For example, volume is usually sent on continuous controller #7. The front panel controller knobs on are pre-programmed to control the XK-6.

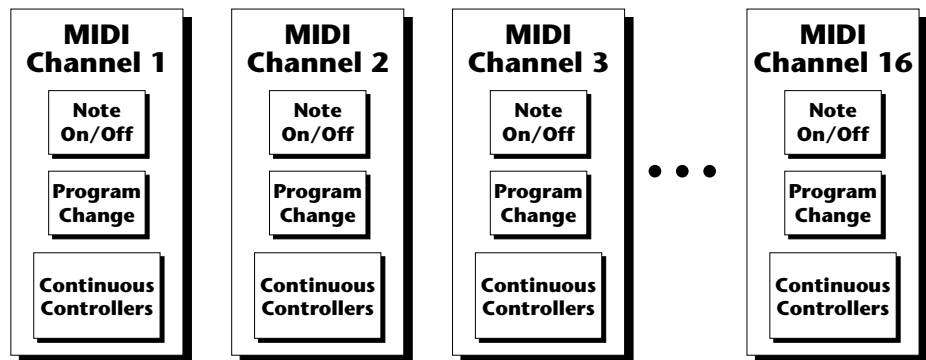

Any MIDI controller can be routed to any modulation destination. First, you have to know which controller numbers your keyboard transmits. Most modern MIDI keyboards let you select a controller number for each control on the keyboard. For example, it may let you select a number from 0-31 for the data slider. The realtime controller numbers that the keyboard transmits must match the numbers XK-6 is receiving, otherwise nothing will happen when you move the controls.

Suppose you wanted to send the four data knobs on another keyboard via MIDI to XK-6. XK-6 can handle up to 16 MIDI controllers (A-P) of your choosing. “MIDI A-P” are simply names for the internal connections that link external MIDI continuous controllers to the PatchCord section of XK-6. There are two parts to the connection. First, MIDI controller numbers are assigned to the letters A-P in the Controllers menu. Next, the letters A-P are connected to synthesizer control parameters in the PatchCord section of the Preset Edit menu. The PatchCord Amount scales the amount of each controller by a positive or negative value.

The factory presets have the MIDI A-P controls connected to standard synthesizer functions (marked on the front panel). By choosing any four of the 16 standard functions, the four sliders on your keyboard will work the

same on every preset. The chart below shows how this might work if your keyboard transmitted the slider settings on MIDI controllers 21-24.

Control	MIDI Controller #	Routing	Standard Function
Slider 1	74	A	Controls Filter Frequency
Slider 2	71	B	Controls Filter Resonance
Slider 3	25	C	Controls Filter Attack
Slider 4	26	D	Controls Filter Decay

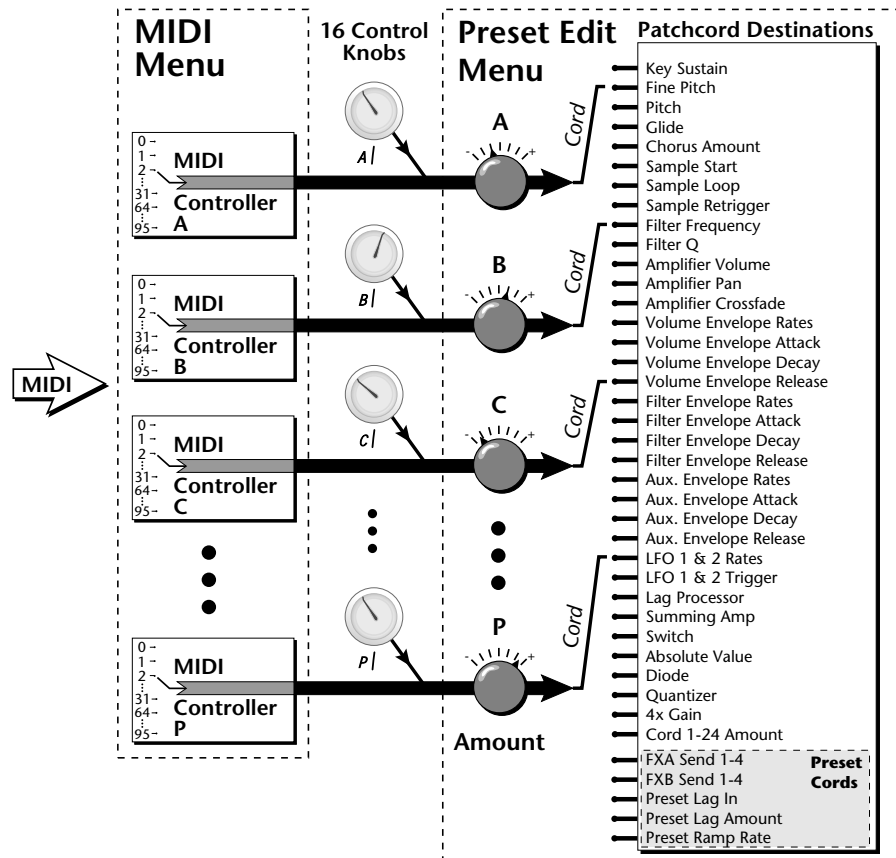

MIDI A-P are internal connections which simultaneously carry front panel controller knob data and MIDI continuous controller data.

The front panel controller knobs work just like MIDI real-time controllers. The four controller knobs can be assigned to the 16 controllers A-P. The front panel knob and incoming MIDI controller messages assigned to that letter, both control the same parameter that you select in the PatchCord screen.

Bank Select Commands

When the original MIDI specification was developed, no synthesizer had more than 40 preset locations. At that time being able to select up to 128 presets didn't seem like much of a limitation. So it was that the original MIDI specification provided for the selection of up to 128 presets.

Musicians wanted *MORE* presets and so the MIDI specification was later amended to include **Bank Select Commands**. It was decided that Bank Select Commands would use Continuous Controllers 0 and 32 to allow the selection of up to 16,384 banks of 128 presets (over two million presets).

Because Bank Selects are implemented using Continuous Controllers, the Bank Selections can be made *per channel*. (This is getting better and better.) For each MIDI channel, you can select any of 16,384 banks and then one of the 128 presets in the bank. Of course no synthesizer has 16,384 banks (yet), but hey, it's nice to know it's possible (for that really BIG project).

Continuous Controller (CC) 0 is the MSB (most significant byte) and CC 32 is the LSB (least significant byte). Normally you send both the MSB and LSB controllers to implement a bank change.

XK-6 remembers the MSB and the LSB that were last sent (or last changed from the front panel). For example, if you have already set the Bank MSB to 04, you need only send the LSB to change banks within the XK-6 sound set. See the MIDI Bank Select chart below.

The selected bank remains selected until you change it (either via MIDI or by changing the bank from the front panel). Standard MIDI Program Change commands select from 128 presets within the selected bank.

 When you press the Audition button, the Bank Select MSB and LSB are displayed on the top line of the display.

<u>MIDI BANK SELECT</u>			
	MSB	LSB	
	cc00	cc32	
USER	00	00	Bank 0
USER	00	01	Bank 1
USER	00	02	Bank 2
USER	00	03	Bank 3
XROM1	07	00	Bank 0
XROM1	07	01	Bank 1
XROM1	07	02	Bank 2
XROM1	07	03	Bank 3

Stereo Mix Outputs

This feature is useful for adding signal processing (EQ, reverb, etc.) of individual sounds prior to final mixdown.

The routing can be performed according to MIDI channel from the Mix Output screen in the Global menu. Simply assign each channel to the desired output.

**Global
Menu**

MIX OUTPUT
channel 01: Send 1->main

To route a particular preset to a Send, first go to the Mix Output screen in the Global menu and set the MIDI channel to “use preset”.

**Global
Menu**

MIX OUTPUT
channel 01: use preset

Next set the Mix Output routing in the preset to the desired output (for each layer). Yes, you can send each layer to a different send if you want.

**Preset Edit
Menu**

L1 MIX OUTPUT
Send 2 -> main

By sending different amounts of presets to the effects, subtle or striking effects can be achieved using the two effect processors. This feature allows you to get the most out of two effects since you can have eight different mixes.

For more information, refer to the diagram on the following page or, See “Mix Output” on page 86.

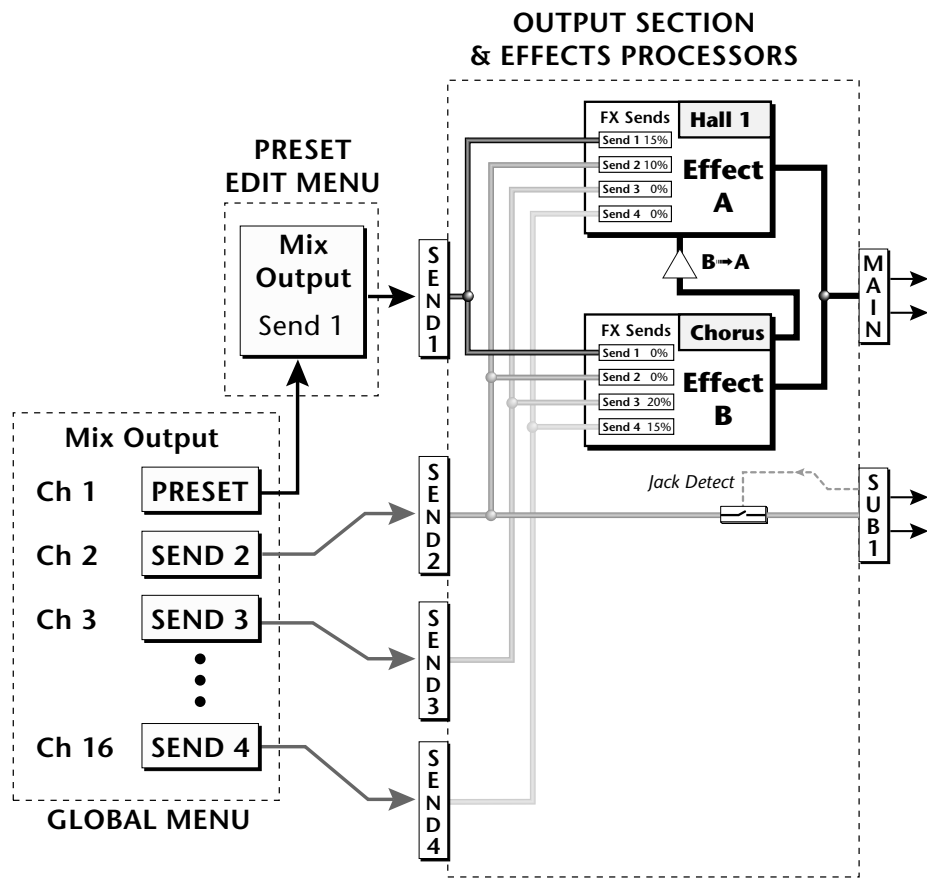

The Mix Output screen in the **Global** menu assigns each MIDI channel to a Send (1-4) or to "Preset".

The Mix Output screen in the **Preset Edit** menu is **ONLY** used if the Global Mix Output is set to "Preset". Otherwise the Preset Edit menu Mix Output settings are ignored.

Preset Edit Menu



While the Preset Edit menu is activated, all incoming MIDI preset changes on the selected channel are ignored.



If there is no "A" option in the Layer field, you must enable the "Edit All Layers" function in the Global Menu (page 92).

The Preset Edit Menu contains four layers of preset parameters that you can modify and then save as preset information in one of the user preset locations. There are four instrument layers in the Preset Edit menu. See the illustration on page 130 for a description of the Preset Layer model.

► To Access the Preset Edit Menu:

Press the Preset Edit button, lighting the LED. The Preset Edit Menu screen displays the menu page most recently selected since powering up XK-6. The cursor appears below the first character of the screen heading on line one.

► To Scroll through Layers:

Place the cursor below the layer field. Rotate the data entry control to select a layer (1-4).

You can also select **All Layers** by choosing "A" in the layer field. When All Layers is selected, the existing parameter value for any field will be displayed if the values of all four layers are equal. If the values of all four layers are NOT equal, the value of layer 1 will be displayed with flashing characters. If you change the parameter value, all layers will assume the new value and the display will stop flashing.

► To Scroll through Pages:

Whenever you are in the Preset Edit menu, the sixteen command buttons function as "jump" buttons to various screens in the Preset Edit menu, which are labelled below each button. Pressing a jump button instantly takes you to the first screen in the selected category. Pressing the button again takes you to the second screen in the category and so on. Repeated pressing will rotate you back to the first screen in the category.

You can also change pages by placing the cursor below the page title field. This will automatically be done when you press the Home/Enter button. Rotate the data entry control to scroll through the pages.

► To Change a Parameter:

Place the cursor below the parameter field. Rotate the data entry control to change the parameter value.

Preset Name

 You can also select characters using the keyboard.

The Preset names consists of two parts: a 3 letter preset category and a 12 letter preset name. Position the cursor under the character location and use the data entry control to change the character.

The preset category is used in conjunction with the Sound Navigator feature. Using the Sound Navigator, a category is selected and the presets in that category are listed in alphabetical order. Creating categories makes it easier to find specific sounds when you need them. For more information on Sound Navigator, see Sound Navigator in Chapter 2: Operations.

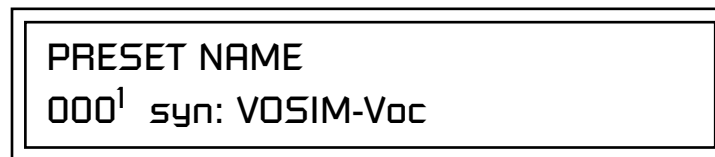

Four Layer Architecture

XK-6 provides a 4 layer instrument structure. Each layer is a complete synthesizer voice with 50 filter types, over 64 modulation sources, more than 64 modulation destinations and 24 patchcords to connect everything together. In addition, the four layers can be crossfaded or switched by key position, velocity or any real-time modulation source.

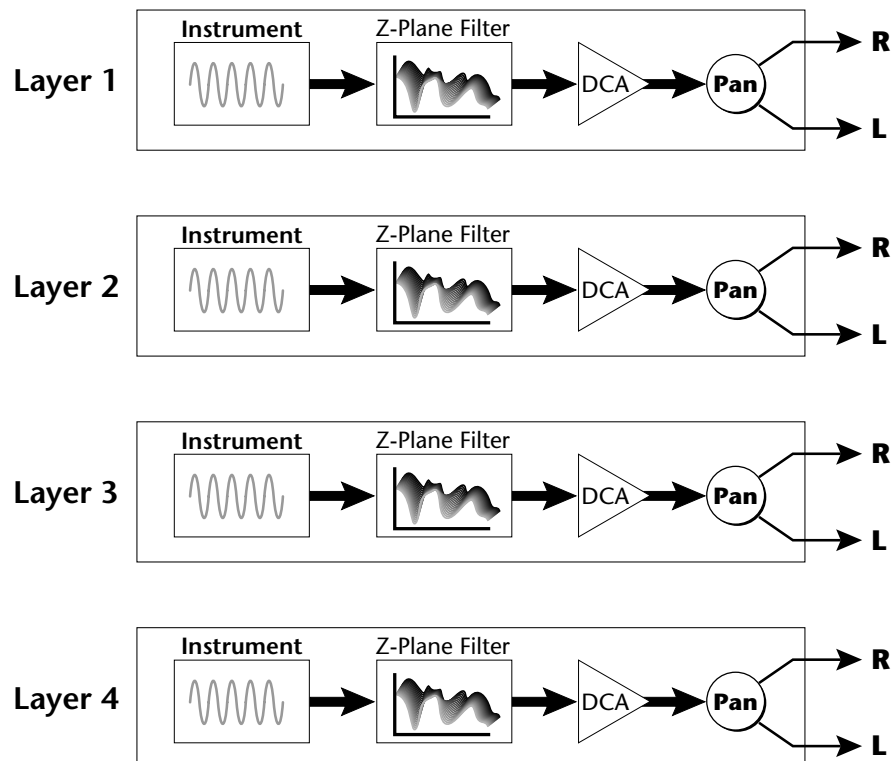

Selecting Layers

In most of the Preset Edit screens, the selected layer is shown in the upper left corner of the display. Layers 1-4 or All can be selected by positioning the cursor on this field and using the data entry control to change the layer. In the screen shown below, Layer 1 is selected.

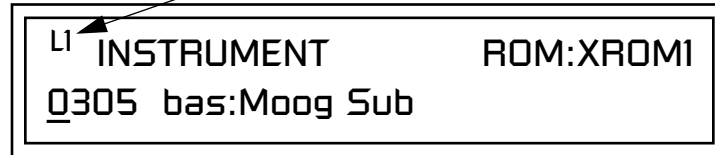

When "All Layers" (A) is selected, the existing parameter value for any field will be displayed if all layers are equal. If the layer parameter values are NOT equal, the value of Layer 1 will be displayed with flashing characters. If you move the data entry control all values will be equal to this new value and the parameter value will no longer flash.

Defining Layer Parameters

Selecting an Instrument

The Preset Edit menu parameters define the four layers and include the instrument assigned to the layer, the ranges of the layer, tuning, envelopes, filters, and patch cords. These parameters are defined for each layer on an individual basis (based on the currently selected layer). See “Common Preset Parameters” on page 161 for global preset settings.

The Instrument parameter defines which of the available instrument sounds is played by the current layer.

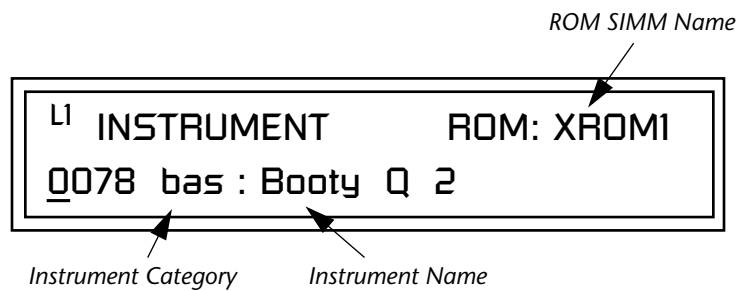

To select an instrument for the selected layer(s), move the cursor to the bottom line of the display and change the instrument using the data entry control.

Sound Navigator

Sound Navigator also works to help select Instruments although the category names are predefined. When the cursor is on the Instrument Category field, turning the data entry control selects different instrument categories. The Name Field will change to show the first instrument in each category. Move the cursor to the instrument name to select instruments in the selected category.

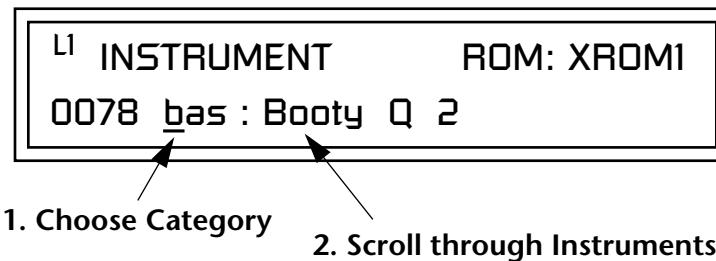

Selecting Categories of Instruments using Sound Navigator.

Defining Key Range

The Key parameter defines the range on the keyboard used by the current layer. The Key range is from C-2 through G8.

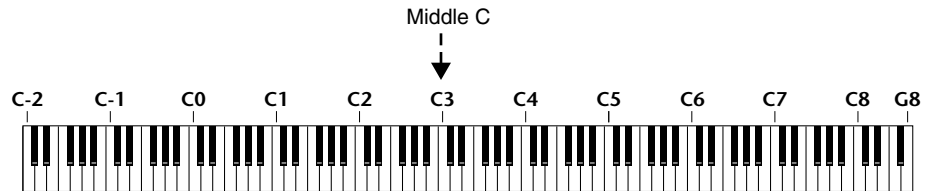

To define the range, set the low key value and the high key value.

You can select key numbers by simply pressing the desired keyboard key when the cursor is positioned on the low or high key field in the display.

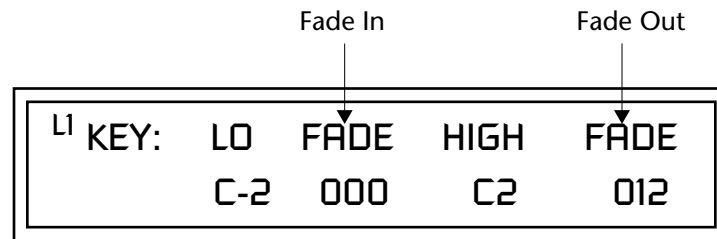

Layers can be crossfaded according to key position by adjusting the Low and High Fade parameters. The first Fade field determines how many semitones it takes the layer to Fade In from the low key. The second Fade field determines how many semitones it takes the layer to Fade Out to the high key. The screen shot above and the diagram below show Layer 1 being faded out over a one octave range.

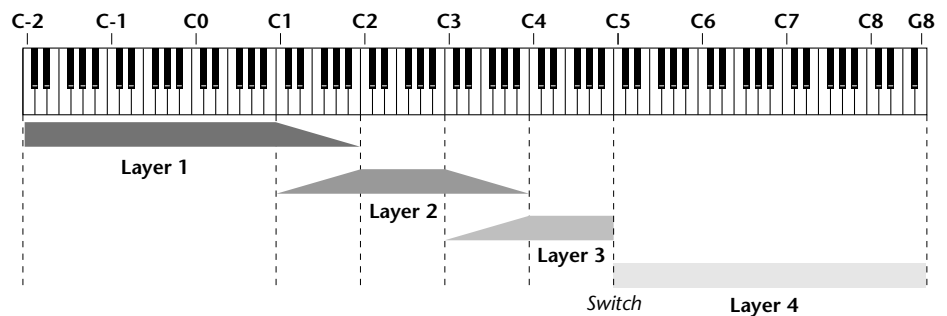

With a High Fade value of zero (as in layer 3 of the diagram), the layer simply switches off at the high key.

► **To Switch Layers According to Key Position:**

The Key Range parameter allows you to create a “split” keyboard with up to four sounds adjacent to each other on the keyboard. This is shown in the diagram below.

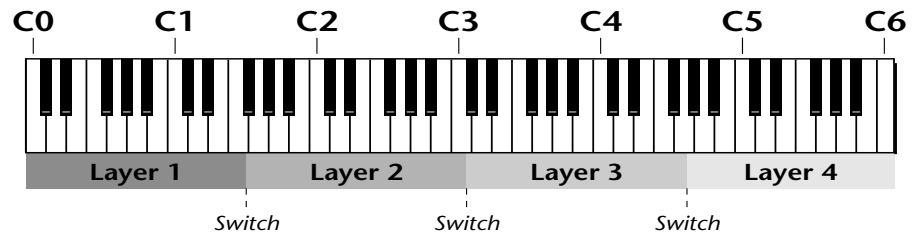

Just assign the low and high key range for each of the four layers with Fade set to zero. Set the Low and High Keys so they don't overlap other layers.

 You can select key numbers by simply pressing the desired keyboard key when the cursor is positioned on the low or high key field in the display.

L ¹ KEY:	LO	FADE	HIGH	FADE
	<u>C</u> 0	000	F1	000

L ² KEY:	LO	FADE	HIGH	FADE
	<u>F</u> #1	000	C3	000

L ³ KEY:	LO	FADE	HIGH	FADE
	<u>C</u> #3	000	F#4	000

L ⁴ KEY:	LO	FADE	HIGH	FADE
	<u>G</u> 4	000	C6	000

If two layers do overlap, both will play as shown in the next example.

► **To Stack Layers:**

If the ranges of two or more Layers overlap it is called *stacking layers*. All Layers assigned to a key sound when the key is played. This is shown in the following diagram. It's very easy to stack layers. Simply duplicate the key ranges for any layers you want to stack.

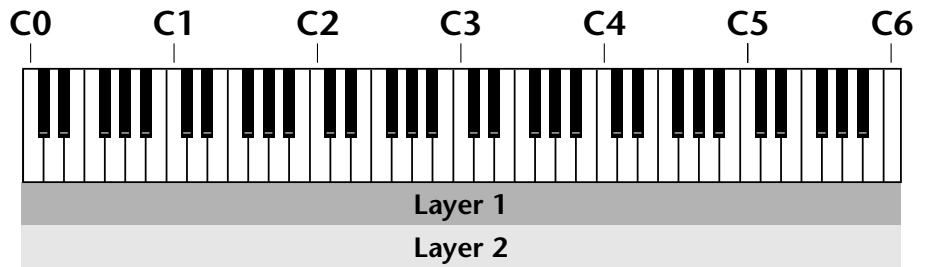

L ¹ KEY:	LO	FADE	HIGH	FADE
	<u>C</u> 0	000	C6	000

L ² KEY:	LO	FADE	HIGH	FADE
	<u>C</u> 0	000	C6	000

Defining the Velocity Crossfade Range

Velocity is a measure of how hard the key is pressed. Velocity Range lets you control the volume of the layers using velocity. Using this function you can crossfade or cross-switch between layers according to how hard you play the keyboard.

Set the velocity range of the layer by defining the high and low velocity values. Values range from 0 (off) to 127 (hardest).

L ² VEL:	LO	FADE	HIGH	FADE
	<u>3</u> 6	012	96	012

The Fade fields define the velocity crossfade range for the currently selected layer. The first Fade field defines the Fade In range for the low velocity value. The second defines the Fade Out range for the high velocity value.

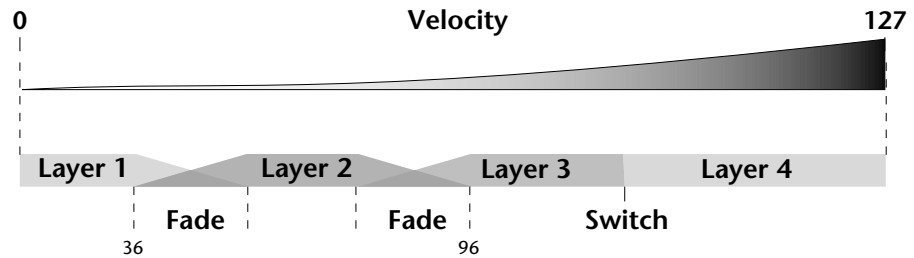

With soft playing, Layer 1 sounds. As you play harder, Layer 1 gradually fades out and Layer 2 fades in. When the keyboard is played hard, Layer 3 plays.

► **To Set Up a Velocity Crossfade Between Layers:**

Set the velocity fades so that layer 1 fades out with higher key velocity, while layer 2 fades in. At a velocity of 64, the two sounds are equal volume. You may want to adjust the fade in and fade out points to achieve a natural sounding crossfade. These parameters vary depending on the sounds.

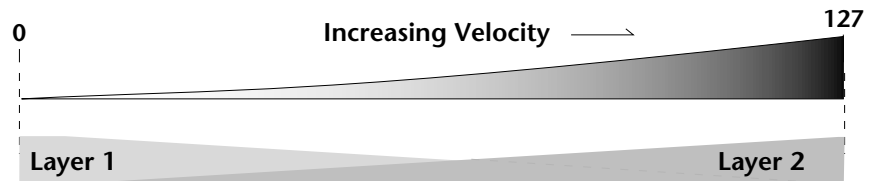

L ¹ VEL:	LO	FADE	HIGH	FADE
	<u>0</u> 00	000	127	127

L ² VEL:	LO	FADE	HIGH	FADE
	<u>0</u> 00	127	127	000

Defining the Real-time Crossfade Range

The Real-time Crossfade window lets you control the volume of the four layers using a real-time controller such as a front panel knob, a pedal or an LFO or Envelope generator. The controller is defined by the PatchCord parameter (see “PatchCords” on page 157).

The Fade fields define the crossfade range in velocity for the currently selected layer. The first Fade field defines the Fade In amount for the low Real-time Control value. The second defines the Fade Out amount for the high Real-time Control value. The Fade value range is from 0 to 127.

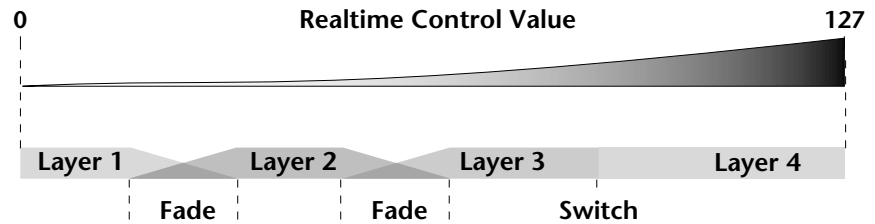

After the Ranges and Fades have been adjusted for each layer in the Real-time Crossfade screen, you must assign a real-time controller to RTXfade (Real-time Crossfade) on each Layer in the PatchCord screen. Set the PatchCord Amounts to +100.

► To Set Up a Real-time Crossfade Between Two Layers:

As the real-time control (knob, pedal, LFO, etc.) is increased, Layer 1 fades out as Layer 2 fades in. This example only uses two of the possible four layers. Refer to the screen diagrams below.

L1	RT:	LO	FADE	HIGH	FADE
		000	000	127	127

L2	RT:	LO	FADE	HIGH	FADE
		000	127	127	000

1. Select a preset.
2. Press the **Preset Edit** button to access the Preset Edit menu.
3. Go to the **Instrument** page and select instruments for Layers 1 and 2.

4. Press **Enter**, then use the data entry control to advance to the **Real-time Crossfade** page.
5. Define the High and Low range of each Layer. In this example the entire range of 0-127 is used.
6. Define the Fades for each Layer. This is just an initial setting. The Range and Fade parameters may have to be adjusted later to get a smooth crossfade.
7. Press **Home/Enter** and use the data entry control to advance to the **PatchCord** page. Select Layer 1.
8. Select the modulation source for the crossfade (knob, pedal, LFO, Envelope) and set the destination to RTXfade. Set the Cord Amount to +100.
9. **Select Layer 2.** Select the same source and destination for the crossfade and set the Cord Amount to +127.

L1 PATCHCORD	#01
MidiA -> RTXfade	+100

10. **Play the keyboard** while adjusting the real-time controller. Go back to the Real-time Crossfade screens to fine tune the crossfade if necessary. Decreasing the fade size will narrow the region where both layers are sounding.

► **To Randomly Cross-Switch Between Four Layers:**

In certain situations, you may want to switch between several layers randomly. **Crossfade Random** is a modulation source specifically designed to handle this situation. Unlike the other random sources, Crossfade Random generates one random number for all layers each time a key is pressed.

To set up a four layer Cross-Switch, simply assign each of the four layers to a different Real-time Crossfade range, then assign XfdRnd to RTXfade in the PatchCords for each layer.

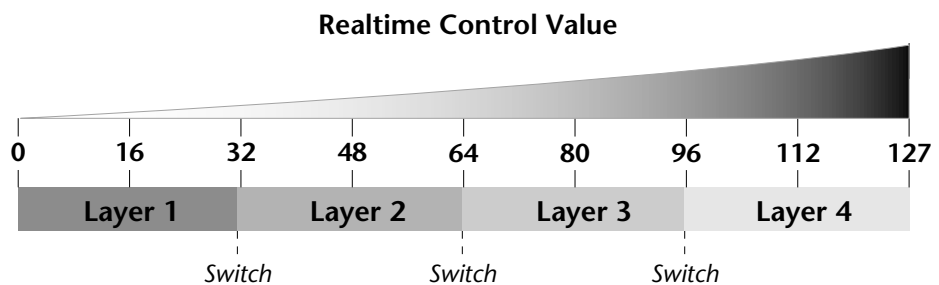

1. Press the **Preset Edit** button to access the Preset Edit menu.
2. Go to the **Instrument** screen and select Instruments for Layers 1 through 4.
3. Press **Enter**, then use the data entry control to advance to the **Real-time Crossfade** page.

L1	RT:	LO	FADE	HIGH	FADE
		000	000	<u>031</u>	000

L2	RT:	LO	FADE	HIGH	FADE
		<u>032</u>	000	063	000

L3	RT:	LO	FADE	HIGH	FADE
		<u>064</u>	000	095	000

L4	RT:	LO	FADE	HIGH	FADE
		09 <u>6</u>	000	127	000

4. Define the High and Low range of each Layer as shown above.
5. Press **Home/Enter** and use the data entry control to advance to the **PatchCord** page. Select Layer 1.
6. Select **XfdRnd** as the modulation source and **RTXfade** as the destination. Set the **Cord Amount** to +100.
7. Repeat step 6 for the remaining three layers.

*Transposing the
Instrument*

L1 PATCHCORD	#01
XfdRand -> RTXfade	+100

8. That's it! Now set each Layer up the way you want. Try radically different instruments, filter settings, or tunings. Or you can make each layer just slightly different for a more natural effect. Try adjusting the Fades or overlapping the ranges if you want more than one layer to play at once.

The Transpose parameter lets you transpose the key of the current layer's Instrument. Transpose works by shifting the keyboard position in semitone intervals relative to middle C. Use this parameter to transpose different layers apart by semitone intervals. For example, by transposing one layer by +7 semitones, it will track other layers at a perfect fifth interval.



The range of transposition is -36 to +36 semitones.

L1 <u>T</u> RANSPOSE
+36 semitones

Tuning

The Tuning parameter changes the pitch of the key in semitone and 1/64 semitone intervals.

L1 <u>T</u> UNING	
Coarse: +36	Fine: +63

Use the Coarse field to shift the tuning by semitone intervals. Use the Fine field to shift tuning by 1/64 semitones (or 1.56 cents) intervals.

Background: Transpose vs. Coarse Tuning

Transpose works by shifting the keyboard assignment of the Instrument (as if you were sliding the keyboard up and down with the Instrument remaining in the same position). Coarse Tuning keeps the instrument placement on the keyboard and actually tunes the samples up using a digital process called interpolation. Use Course Tuning on drum instruments to change the pitch while keeping sample placement constant. Coarse Tuning can also be useful to slightly change the timbre of the instrument.

Amplifier

This parameter sets the initial volume and pan position of the current layer. These values can be changed using any Real-time Controller set up in the PatchCords. The value range for the volume is from -96 dB to +10 dB. 0 dB is the default setting. Routinely turning the volume up to +10 dB is not recommended because it doesn't allow other modulation sources to increase the volume further.

L1 <u>A</u> MPLIFIER	
Volume: +10dB	Pan: 48L

This field determines the initial Pan value for the current layer. The value range for Pan is from 64L to 0 (left) and 0 to 63R (right). Pan adjusts the volume into the left and right output channels relative to the Pan setting in the main Preset Select screen (see "Channel Pan" on page 39). So, if you, for example, set the Pan value in the Preset Select screen to 64L and set this Pan value to 63R, the actual pan amount would be 0 as these two pan parameters are relative to each other.

Volume Envelope

 *Factory Mode is useful for Instruments containing multiple drums, since each drum can have its own envelope settings.*

A factory drum kit envelope actually contains a separate envelope for every voice on every key instead of a single global envelope.

 *If two adjacent segments have the same level in a "time-based" envelope, the segment will be skipped. Adjacent segments must have different levels for the rate control to work.*

An envelope can be described as a "contour" which is used to shape the sound over time. The *Volume Envelope* controls the volume of the sound in the current layer over time. The way the volume of a sound evolves has a profound effect on how we perceive the sound.

Each instrument has its own Factory preset Volume Envelope setting. The Volume Envelope allows you to program your own envelope settings.

Selecting the Mode

The Mode field determines whether the layer will use the instrument's default envelope (Factory) or use the user-programmed Volume Envelope. There are three mode options and repeat.

- **Factory:** Uses the factory preset envelope contained in each instrument. If you select the "Factory" mode, the Volume Envelope parameters are disabled and the factory defined settings are used instead.

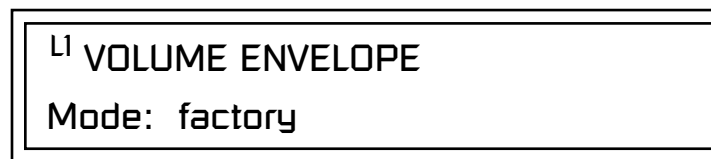

- **Time-based:** Defines the Volume Envelope rates from 0 to 127 (approximately 1 ms to 160 seconds). The Master clock has no affect on time-based rates.
- **Tempo-based:** The Volume Envelope times vary based on the master tempo setting. Note values are displayed instead of a number when the time corresponds to an exact note value. Tempo-based envelopes are useful when using external sequencers and arpeggiators because the envelope rates compress and expand according to the Master Tempo setting, keeping the envelopes in sync with the sequence or arpeggio.

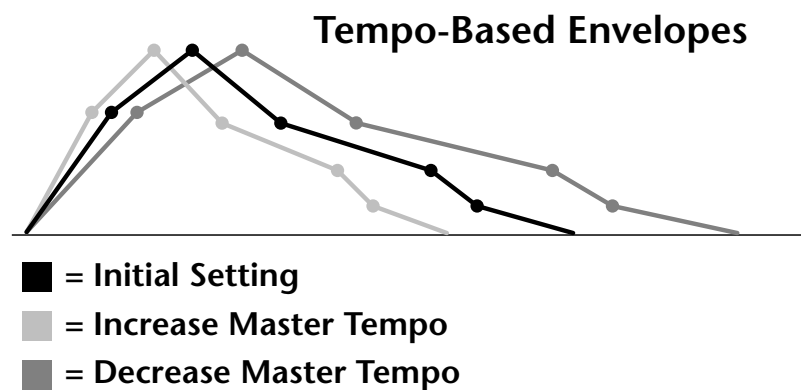

Tempo-based envelope rates change according to the Master Tempo rate.

 See the Programming Basics section of this manual for detailed information about how the Envelopes work.

Defining the Volume Envelope

The Volume Envelope controls the volume of the layer over time. The Volume Envelope has six stages to the contour: Attack 1, Attack 2, Decay 1, Decay 2, Release 1 and Release 2. When a key is pressed, the Envelope goes through the first four stages. If you continue to hold down the key, the envelope holds at the Decay 2 level. When the key is released, the envelope continues through the Release stages ending at the Release 2 level.

L1	VOL ENV	RATE	LEVEL
	<u>A</u> ttack 1	84	100%

As soon as the Attack 1 level is reached, the Attack 2 phase begins. When the Attack 2 Level is reached, the Decay 1 phase begins. When the key is released, the envelope immediately jumps to the Release 1 stage, then the Release 2 stage finally ending at the Release 2 level.

If you have selected the factory mode, the Volume Envelope parameter screen looks like the following illustration.

L1	VOL ENV	RATE	LEVEL
	(using factory envelope)		

 If the Release 2 level is set at a value other than zero, the note will continue to sound after the key is released. This might be useful for drone effects, but the channel won't stop sounding until all channels are used up.

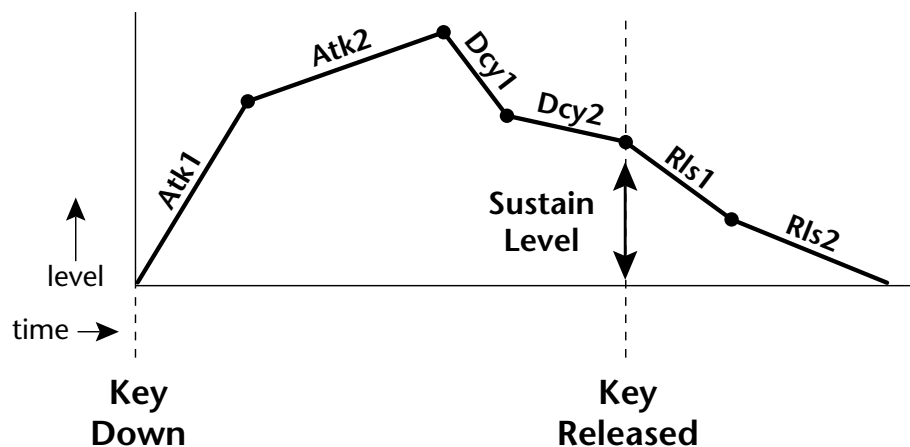

On the Volume Envelope, levels can only be set to positive values. The value range is from 0 to +100.

Chorusing the Layer



WARNING: Because it works by doubling instruments, Chorusing halves the number of notes you can play.

Chorusing “thickens” the sound by doubling the sound in stereo and then detuning it. Every layer with chorus turned on uses twice the polyphony for that layer.

L1 CHORUS	WIDTH
off	100%

The first field in this screen turns Chorus On or Off and allows you to adjust the amount of detuning (1 to 100%). The *Width* parameter controls the stereo spread. 0% reduces the chorus to mono and 100% provides the most stereo separation.

Sound Start Offset and Delay

Sound Start sets where the instrument begins playing when you hit a key. Setting the Start Offset amount to “0” plays the sample from the beginning. Higher values move the Sample Start Point further into the sample toward the end. There is also a PatchCord source which can be used to change the Sound Start point at note-on time.

L1 SOUND	START	DELAY
	127	127

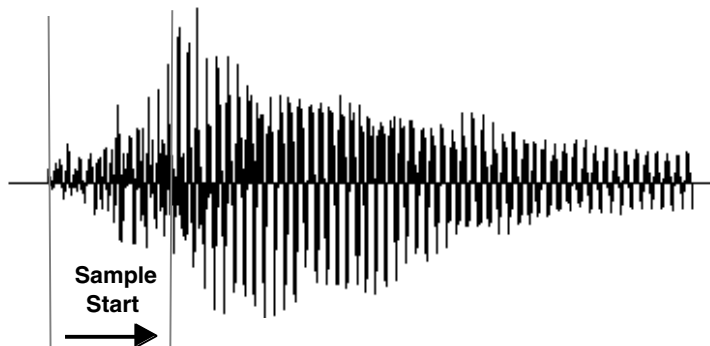

Controlling the Sound Start using Key Velocity (< Amt -) brings in the attack of the wave only when you play hard. This is especially effective with percussion instruments.

Delay defines the time between when you hit a key (note-on) and the onset of the current layer’s note and the start of the envelopes (if applicable). Delay values below zero are *Tempo-based* values, meaning the time is based on the Master Tempo setting. Note values are displayed by adjusting the Delay Time value below zero. The sound will be delayed by the selected note value based on the master clock.

Non-Transpose Mode

This function turns keyboard transposition On or Off for the current layer. With Nontranspose “on,” the keyboard will not control the pitch of the instrument. This is a useful function for drones, attack “chiffs,” or other sound effects which you may not want to track the keyboard.



Solo Mode

Provides the playing action of a monophonic instrument such as a lead synthesizer by preventing more than one note from sounding at once. There are eight different solo modes provided. Try setting up different layers with different solo mode and glide rates or combine solo mode with polyphonic playing modes.

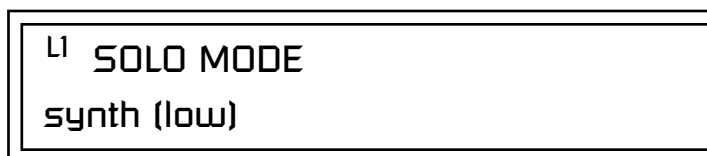

In order to define a monophonic glide (see the Portamento parameter), you must be in Solo mode.

The Solo modes are:

Multiple Trigger: Last note priority. No key-up action. Retrigger envelopes and samples when a key is pressed.

Melody (last): Last note priority. No key-up action.

First solo note: Envelopes start at Attack segment from zero. Samples start at the beginning.

If previous note is releasing: Envelopes start at Attack segment, but from current level. Samples start at the beginning.

When playing “Legato”: Envelopes continue from current segment and level. Samples start at the loop or the beginning if unlooped.

Melody (low): Same as Melody (last), but with low note priority. Newly played keys which are higher than the lowest solo key held do not sound.

Melody (high): Same as Melody (last), but with high note priority. Newly played keys which are lower than the highest solo key held do not sound.

Synth (last): Similar to Melody (last) but this mode has key-up action. When you release the currently sounding solo key while holding other keys down, the highest held solo key sounds in a Legato fashion.

Assign Group

Synth (low): Same as Synth (last) but with low note priority. When you release the currently sounding solo key while holding other keys down, the lowest held solo key sounds in a Legato fashion (MiniMoog).

Synth (high): Same as Synth (last) but with high note priority. When you release the currently sounding solo key while holding other keys down, the highest held solo key sounds in a Legato fashion.

Fingered Glide: Same as Synth (last), except that Glide is disabled when playing Staccato, enabled when playing Legato.

Use the Assign Group parameter to assign a certain number of channels to each layer. By assigning all voices in the preset to assign groups, important parts are protected from being “stolen” by more recently played keys. Or you can assign a voice, such as an open high hat, to a mono channel so it is cancelled by a closed high hat on the same mono channel. Layers rotate within their assigned “bin” of channels, not interfering with other bins.



The modes are:

Poly All: Notes are played polyphonically with dynamic channel assignment using all 64 channels.

Poly 16 A-B: Two bins of 16 channels each. Notes are played polyphonically with dynamic channel assignment using no more than 16 channels.

Poly 8 A-D: Four bins of 8 channels each. Notes are played polyphonically with dynamic channel assignment using no more than 8 channels each.

Poly 4 A-D: Four bins of 4 channels each. Notes are played polyphonically with dynamic channel assignment using no more than 4 channels each.

Poly 2 A-D: Four bins of 2 channels each. Notes are played polyphonically with dynamic channel assignment using no more than 2 channels each.

Mono A-I: Nine monophonic channels. Any layers assigned to the same letter interrupt each other without affecting other layers.

Glide

Glide creates a smooth transition from one note to the next instead of the normal instantaneous change in pitch when a new key is pressed. This effect is commonly heard on slide guitars, synthesizers and violins.



The front panel **Glide Button** LED comes on when the any layer of the current preset has a glide rate greater than 0.000 seconds (regardless of if a PatchCord is connected or not). Pressing the button turns the LED and glide off. Pressing the front panel glide button when all layers are set to a glide of 0.000 turns glide on with a rate of 0.142 seconds/octave.

The **Glide Rate** parameter defines the time it takes to glide to the new pitch (the larger the value, the slower the glide rate) The glide rate value range is from 0 through 32.738 seconds (zero means off).

The **Glide Curve** describes how the glide accelerates as it slides between notes. Because of the ear's non-linear response to pitch, a linear glide sounds slow at the beginning and speeds up toward the end. Exponential curves actually sound smoother and more linear. Eight exponential curves are provided. Choose one that suits your style.

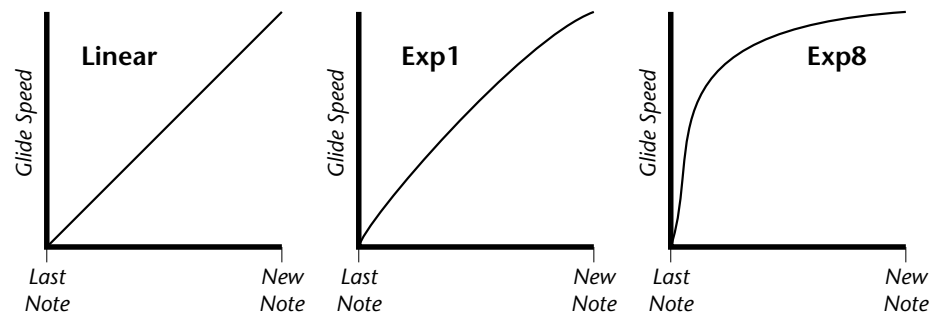

Glide can be either polyphonic or monophonic depending of the state of *Solo Mode*.

► To Set up a Glide Rate Knob:

1. Set at least one layer to the minimum setting of 0.002 sec/oct. (This forces the Glide LED to come on.)
2. Connect the MIDI controller of your choice to Glide Rate on the layers you'd like to glide. Adjust the Cord Amount for the desired range.
3. Disconnect the MIDI controller from whatever else it was connected to before you started mucking about.
4. The Glide button turns Glide on/off and the knob controls the rate.

Z-Plane Filters

A filter is a device which changes the output of a signal (sound) by removing certain elements of the signal based on the frequency and amplitude. The “Order” of a filter defines the number of filter elements it contains. The more elements, the more complex the filter.

XK-6 contains 50 different types of E-MU’s celebrated Z-plane filters. In addition to the standard Low pass, High pass and Band pass filters, XK-6 contains Swept Octave Equalizers, Phasers, Flangers, Vocal Formant Filters, and digital models of classic synthesizer filters.

In the filter chart below you will notice that the “Order” of the filters varies from 2 to 12 order. Higher order filters have more sections and can produce more complex formants. XK-6 can produce 128 filters of up to 6th order or 64 filters of 12th order complexity. Therefore, if you decided to use all 12th order filters, XK-6 would be limited to 64 voices.

XK-6 Filter Types

This screen allows you to choose the type of filter for the current layer.

L1 FILTER	Ord	Type
Phazer 2 E4	6	PHA

Filter Types	
LPF	Low-pass filter
PHA	Phaser
HPF	High-pass filter
FLG	Flanger
BPF	Band-pass filter
VOW	Vowel/ formant
EQ+	EQ boost
EQ-	EQ cut
SFX	Special Effect

Filter Name	Order	Type	Description
Smooth	02	LPF	Typical OB type low-pass filter with a shallow 12 dB/octave slope.
Classic	04	LPF	4-pole low-pass filter, the standard filter on classic analog synths. 24 dB/octave rolloff.
Steeper	06	LPF	6-pole low-pass filter which has a steeper slope than a 4-pole low-pass filter. 36 dB/octave rolloff!
MegaSweepz	12	LPF	“Loud” LPF with a hard Q. Tweeters beware!
EarlyRizer	12	LPF	Classic analog sweeping with hot Q and Lo-end.
Millennium	12	LPF	Aggressive low-pass filter. Q gives you a variety of spiky tonal peaks.
KlubKlassik	12	LPF	Responsive low-pass filter sweep with a wide spectrum of Q sounds
BassBox-303	12	LPF	Pumped up lows with TB-like squelchy Q factor.
Shallow	02	HPF	2-pole high-pass filter. 12 dB/octave slope.
Deeper	04	HPF	Classic 4-pole high-pass filter. Cutoff sweep progressively cuts 4th Order High-pass.
Band-pass1	02	BPF	Band-pass filter with 6 dB/octave rolloff on either side of the passband and Q control.
Band-pass2	04	BPF	Band-pass filter with 12 dB/octave rolloff on either side of the passband and Q control.

Filter Name	Order	Type	Description
ContraBand	06	BPF	A novel band-pass filter where the frequency peaks and dips midway in the frequency range.
Swept1>1oct	06	EQ+	Parametric filter with 24 dB of boost or cut and a one octave bandwidth.
Swept2>1oct	06	EQ+	Parametric filter with 24 dB of boost or cut. The bandwidth of the filter is two octaves wide at the low end of the audio spectrum, gradually changing to one octave wide at the upper end.
Swept3>1oct	06	EQ+	Parametric filter with 24 dB of boost or cut. The bandwidth of the filter is three octaves wide at the low end of the audio spectrum, gradually changing to one octave wide at the upper end.
DJAlkaline	12	EQ+	Band accentuating filter, Q shifts "ring" frequency.
AceOfBass	12	EQ+	Bass-boost to bass-cut morph
TB-OrNot-TB	12	EQ+	Great Bassline "Processor."
BolandBass	12	EQ+	Constant bass boost with mid-tone Q control.
BassTracer	12	EQ+	Low Q boosts bass. Try sawtooth or square waveform with Q set to 115.
RogueHertz	12	EQ+	Bass with mid-range boost and smooth Q. Sweep cutoff with Q at 127.
RazorBlades	12	EQ-	Cuts a series of frequency bands. Q selects different bands.
RadioCraze	12	EQ-	Band limited for a cheap radio-like EQ
AahAyEeh	06	VOW	Vowel formant filter which sweeps from "Ah" sound, through "Ay" sound to "Ee" sound at maximum frequency setting. Q varies the apparent size of the mouth cavity.
Ooh-To-Aah	06	VOW	Vowel formant filter which sweeps from "Oo" sound, through "Oh" sound to "Ah" sound at maximum frequency setting. Q varies the apparent size of mouth cavity.
MultiQVox	12	VOW	Multi-Formant, Map Q To velocity.
Ooh-To-Eee	12	VOW	Oooh to Eeee formant morph.
TalkingHedz	12	VOW	"Oui" morphing filter. Q adds peaks.
Eeh-To-Aah	12	VOW	"E" to "Ah" formant movement. Q accentuates "peakiness."
UbuOrator	12	VOW	Aah-Uuh vowel with no Q. Raise Q for throaty vocals.
DeepBouche	12	VOW	French vowels! "Ou-Est" vowel at low Q.
PhazeShift1	06	PHA	Recreates a comb filter effect typical of phase shifters. Frequency moves position of notches. Q varies the depth of the notches.

Filter Name	Order	Type	Description
PhazeShift2	06	PHA	Comb filter with slightly different notch frequency moving the frequency of notches. Q varies the depth of the notches.
FreakShifta	12	PHA	Phasey movement. Try major 6 interval and maximum Q.
CruzPusher	12	PHA	Accentuates harmonics at high Q. Try with a sawtooth LFO.
FlangerLite	06	FLG	Contains three notches. Frequency moves frequency and spacing of notches. Q increases flanging depth.
AngelzHairz	12	FLG	Smooth sweep flanger. Good with vox waves. eg. I094, Q =60
DreamWeava	12	FLG	Directional Flanger. Poles shift down at low Q and up at high Q.
MeatyGizmo	12	REZ	Filter inverts at mid-Q.
DeadRinger	12	REZ	Permanent "Ringy" Q response. Many Q variations.
ZoomPeaks	12	REZ	High resonance nasal filter.
AcidRavage	12	REZ	Great analog Q response. Wide tonal range. Try with a sawtooth LFO.
BassOMatic	12	REZ	Low boost for basslines. Q goes to distortion at the maximum level.
LucifersQ	12	REZ	Violent mid Q filter! Take care with Q values 40-90.
ToothComb	12	REZ	Highly resonant harmonic peaks shift in unison. Try mid Q.
EarBender	12	WAH	Midway between wah & vowel. Strong mid-boost. Nasty at high Q settings.
FuzziFace	12	DST	Nasty clipped distortion. Q functions as mid-frequency tone control.
BlissBatz	06	SFX	Bat phaser from the Emulator 4.
KlangKling	12	SFX	Ringing Flange filter. Q "tunes" the ring frequency.

Filter Parameters

The Freq and Q parameters control various elements of the filter depending on the type of filter used. See the table in the *Filter Types* section for details about what the Freq and Q fields control in each filter.

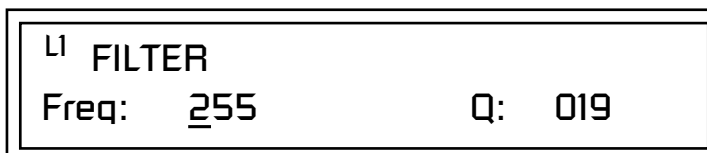

Filter Envelope

The Filter Envelope is normally used to control the filter frequency and has six stages. Unlike the Volume Envelope, the Filter Envelope must be patched to the Filter Frequency using a PatchCord. In this respect, it can be thought of as a general purpose envelope generator which is normally patched to control the filter. The Filter Envelope Levels can be negative as well as positive.

There are three mode options:

- **Time-based:** Defines the Filter Envelope rates from 0 to 127 (approximately 1 ms to 160 seconds). The Master clock has no affect on time-based rates.

L1	FILT ENV	RATE	LEVEL
	Attack 1	<u>8</u> 4	100%

- **Tempo-based:** The Filter Envelope times vary based on the master tempo setting and are displayed in values such as 1, 2, 3, etc. Note values are displayed instead of a number when the time corresponds to an exact note value. Tempo-based envelopes are useful when using arpeggiators and sequencers because the envelope rates compress and expand according to the Master Tempo setting, keeping the envelopes in sync with the music. See the illustration on page 104.

L1	FILT ENV	RATE	LEVEL
	Attack 1	<u>1</u> /4	100%

- **Envelope Repeat:** The Envelope Generators can also be made to repeat. When the envelope repeat function is On, the Attack (1&2) and Decay (1&2) stages will continue to repeat as long as the key is held. As soon as the key is released, the envelope continues through its normal Release stages (1 & 2). For more information see page 104.

► To Turn on Envelope Repeat:

1. Move the cursor until it is underneath the Mode field as shown below.

L1	FILTER ENVELOPE
	<u>M</u> ode: time-based

2. Turn the data entry control clockwise. The lower line changes to:



3. Move the cursor underneath the on/off field, then turn the data entry control clockwise so that Repeat is On.

Defining the Filter Envelope

The Filter Envelope controls the filter frequency of the layer over time. The Envelope has six stages to the contour: Attack 1, Attack 2, Decay 1, Decay 2, Release 1 and Release 2. When a key is pressed, the Envelope goes through the first four stages. If the key continues to be held, the envelope holds at the Decay 2 level. When the key is released, the envelope immediately jumps to the Release 1 stage, then the Release 2 stage finally ending at the Release 2 level.

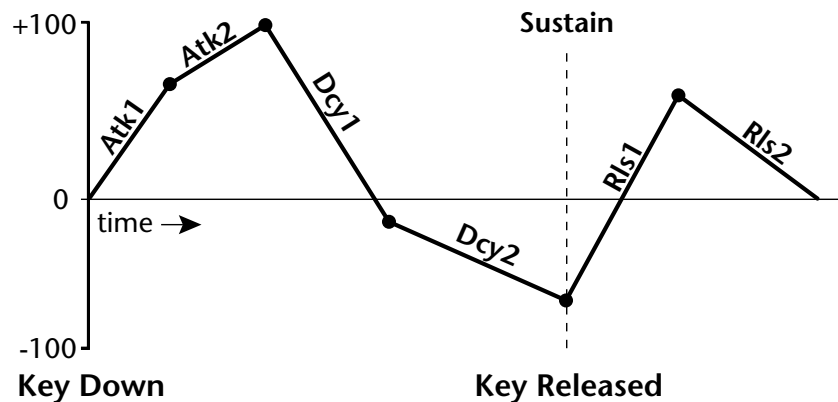

See the Programming Basics section of this manual for detailed information about how the Envelopes work.

The default PatchCord settings connect the Filter Envelope to Filter Frequency but the envelope can be routed to any real-time control destination using a PatchCord.

Auxiliary Envelope

The Auxiliary Envelope is a supplementary general purpose envelope that can be routed to any real-time control destination in the PatchCords. It is identical to the filter envelope generator. See “Filter Envelope” on page 151 for full details.

Low Frequency Oscillators (LFOs)

A Low Frequency Oscillator or LFO, is simply a wave that repeats at a slow speed. XK-6 has two LFOs per layer identified on the display as LFO1 and LFO2.

An LFO can be routed to any real-time control destination using a PatchCord. LFOs have a myriad of uses, some of which probably haven't been thought of yet. The following examples show a few common uses.

- Control the pitch of the sound (LFO -> Pitch). This effect is called "vibrato" and is an important performance tool. Many presets use this routing with the modulation wheel controlling "how much" modulation is applied.
- Create a "tremolo" effect by routing the LFO to control the volume (LFO -> AmpVolume).
- Add a bit of animation to the sound by routing the LFO to control the filter. Set the PatchCord amount low for a subtle effect.

The LFOs have five parameters: Shape, Sync, Rate, Delay and Variation.

Shape

LFO waveforms have different shapes. The shape of the waveform determines the effect of the LFO. LFOs have traditionally been used to add vibrato or repeating movement to a sound. These new shapes offer a lot of new programming possibilities.



If you modulate the pitch of an instrument, it's easy to visualize the shape of the waveform. For example, the sine wave has a smooth, rolling shape that changes the pitch smoothly. The square waveform changes between two pitches abruptly. A sawtooth waveform increases the pitch smoothly, then abruptly changes back down. The available waveforms are shown below.

LFO Tricks & Tips:

- The Random LFO wave is truly random and is different for each voice and layer.
- The Pattern (Pat) waveforms will sound the same on different layers and voices.
- Sine + Noise is very useful for simulating trumpet and flute vibrato.

★ When routing Hemi-quaver to Pitch:

- +38 = major scale
- 38 = phrygian scale
- +76 = whole tone scale
- (+38) + (+76) = diminished (two cords)
- odd amount = S+H sound

Note: References to musical intervals in the pattern LFO shapes are with the LFO routed to pitch and a PatchCord amount of +38.

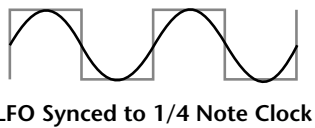
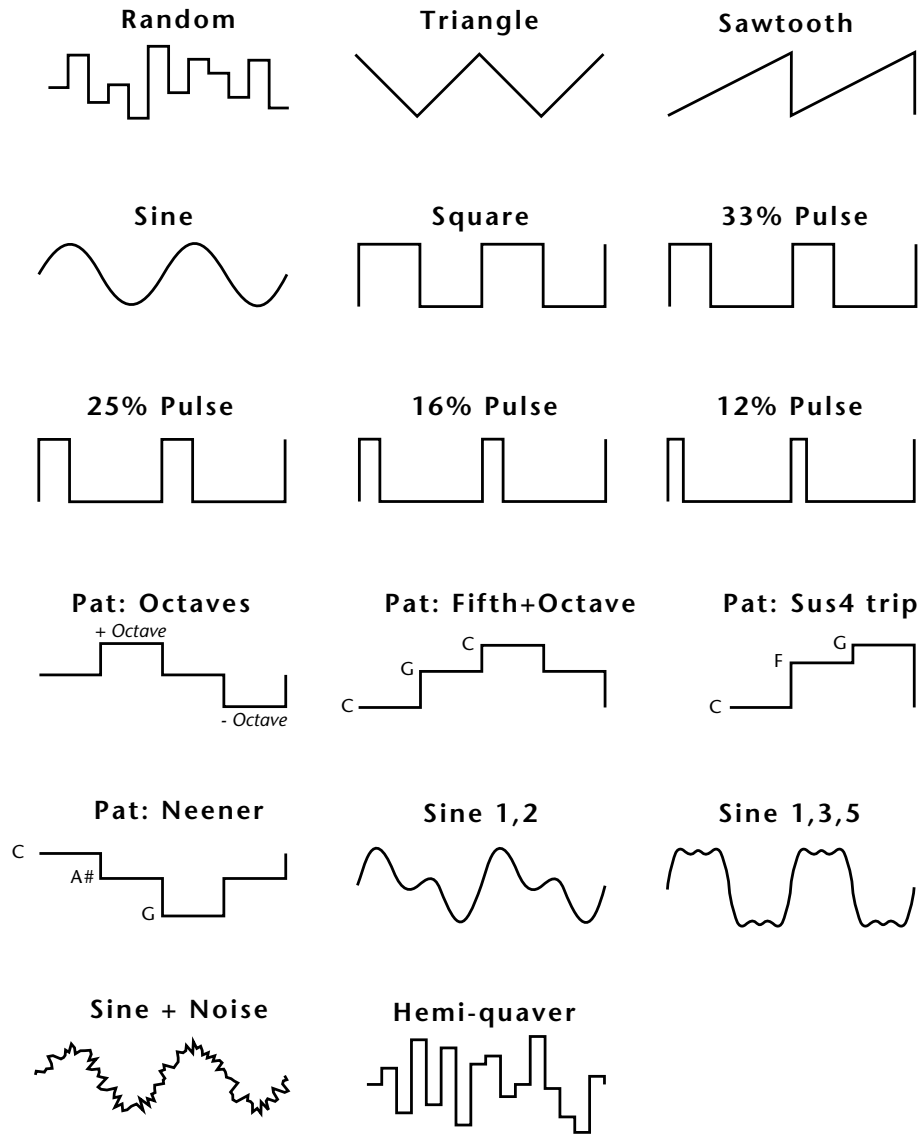

Sync

The Sync field specifies whether the LFO is synchronized to a key stroke or is Free Running. Key Sync starts the LFO wave at the beginning of its cycle each time you press a key on the controller. In Free Run mode, the LFO wave begins at a random point in its cycle each time you press a key on the controller.

Rate

The Rate field determines the LFO speed in absolute frequency rate values or tempo-based note values. All values equal to or greater than zero specify absolute frequency values from 0.08 Hz to 18.14 Hz.

Values less than zero specify tempo-based rates. If you modulate the rate of a tempo-based LFO, the rates will jump between the tempo-based note values with each PatchCord increment of "1". As an example: if the LFO rate was set to 8/1 and you patched the Mod Wheel to control rate with a PatchCord amount of +1, turning the Mod Wheel to maximum would change the LFO rate to 4/1d. Refer to the chart below.

L1	LFO1	RATE	DELAY	VAR
		<u>0</u> .08Hz	60	020

Tempo-based Rates (based on Master Tempo)	Display
octal whole note	8/1
dotted quad whole note	4/1d
octal whole note triplet	8/1t
quad whole note	4/1
dotted double whole note	2/1d
quad whole note triplet	4/1t
double whole note	2/1
dotted whole note	1/1d
double note triplet	2/1t
whole note	1/1
dotted half note	1/2d
whole note triplet	1/1t
half note	1/2
dotted quarter note	1/4d
half note triplet	1/2t
quarter note	1/4
dotted 8th note	1/8d
quarter note triplet	1/4t
8th note	1/8
dotted 16th note	1/16d
8th note triplet	1/8t
16th note	1/16
dotted 32nd note	1/32d
16th note triplet	1/16t
32nd Note	1/32

Delay

The Delay parameter defines the amount of time between hitting a key on the controller and the onset of the LFO modulation. Delay can be used to simulate an effect often used by acoustic instrument players where the vibrato is brought in only after the initial note pitch is established. The following illustration demonstrates how delay works.

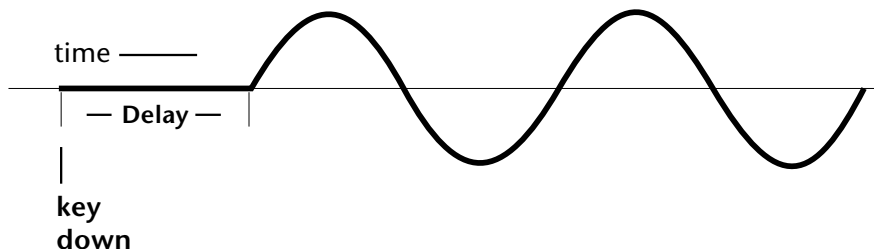

All Delay values equal to or greater than zero specify absolute time rates from 0 to 127. Values less than zero specify Tempo-based mode. Refer to the previous table for times and tempo-based rates.

Variation

LFO Variation sets the amount of random variation of the LFO each time you press a key on the controller. This creates a chorus or ensemble effect since each note played has a slightly different modulation rate. The higher the value entered, the greater the note to note variation in the LFO.

The Variation value range is from 0 through 100.

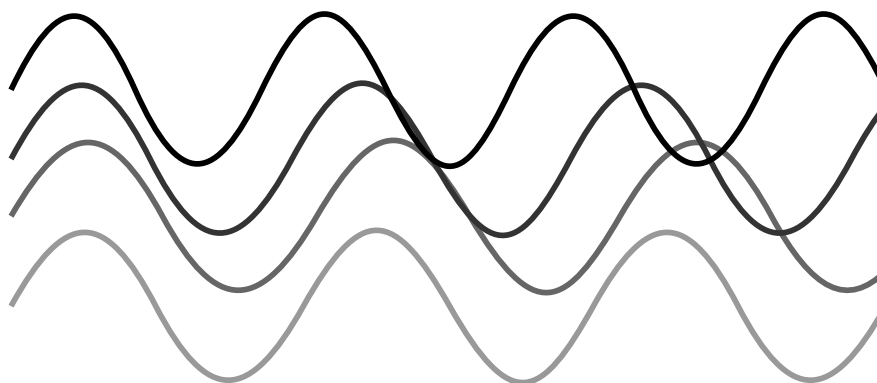

LFO variation changes the rate of each note to create an “ensemble” effect.



Variation is disabled when a Tempo-Based LFO is selected.

PatchCords

PatchCords tie everything together by connecting modulation sources to destinations. Each PatchCord has its own *Amount* control which can be positive or negative (negative amounts invert the signal). In addition, the PatchCord amounts themselves can be controlled by any modulation source. XK-6 provides 24 patches for each layer.

There are three permanently connected control routings: volume envelope to amplifier, pitch wheel to pitch and key to pitch. All other connections must be made using the PatchCords.

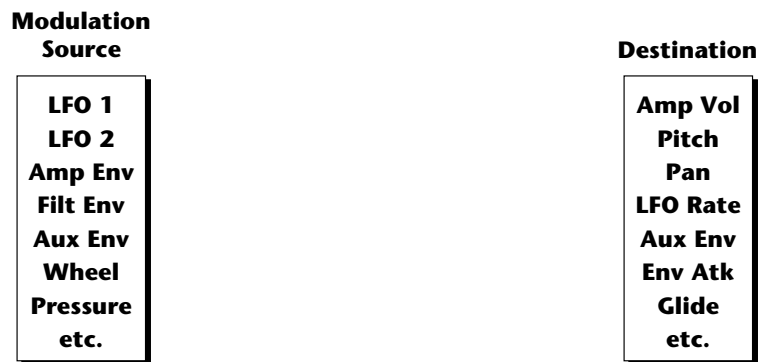
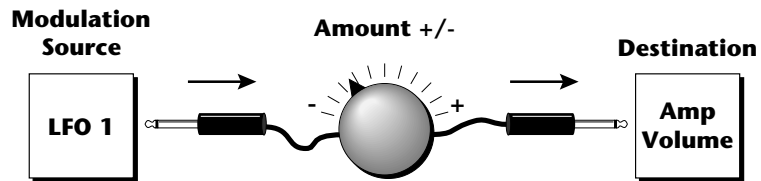

Each patch has an amount field which determines how much modulation is applied to the destination. The modulation amount can be positive or negative. Negative values invert the input. The amount value range is from -100 to +100.

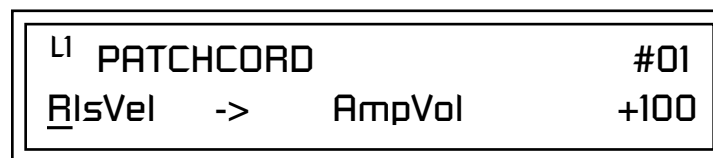

Modulator Polarity

You will notice that some of the modulation sources have symbols following their names. For example, there are three Velocity modulation sources, Vel +, Vel ±, and Vel <.

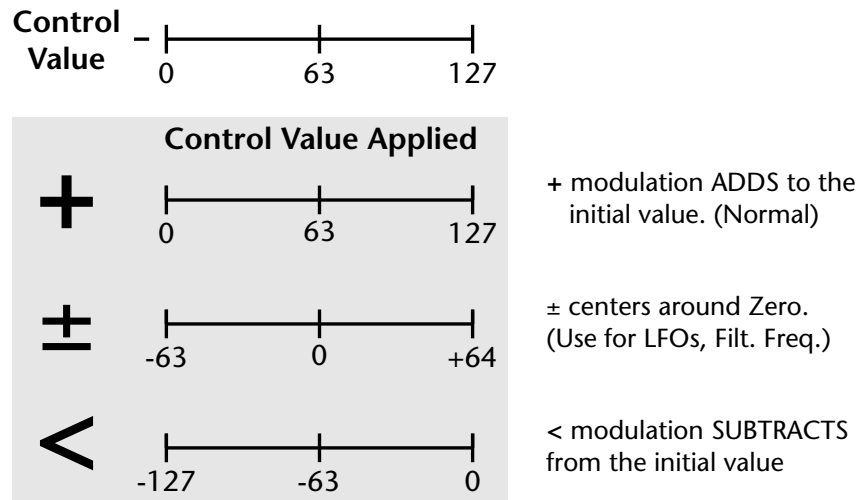

“+” Modulation: Uses only the positive half of the range, adding to the current value. For example, if the filter frequency were set to 100 and you patched Vel+ to the filter, the filter frequency would increase from 100 as velocity was applied.

“±” Modulation: Uses both sides (full) range and both adding and subtracting from the current value. For example, if the filter frequency were set to 100 and you patched Vel ± to the filter, the filter frequency would decrease from 100 with key velocities of 63 or less and increase from 100 with key velocities of 64 and above. Therefore with medium velocity, the Filter frequency is approximately where you set it at 100.

An LFO ± works the same way; on the positive half of the cycle it increases the initial amount and on the negative half of the cycle it decreases the initial amount. With a ± modulation source, a value of 64 equals 0.

“<” Modulation: Uses only the negative half of the range, subtracting from the current value. For example, if the Amplifier Volume were set to +3 dB and you patched Vel < to AmpVol, the volume would be at +3 dB only when maximum key velocity were applied. Lower key velocities would scale back the volume. In general, < modulation is the proper choice when modulating Volume.

Here is a list of all layer modulation sources and destinations in XK-6.

Modulation Sources:

Off
 Key (+, ±)
 Velocity (+, ±, <)
 RlsVel (Release Velocity)
 Gate
 Pressure (Aftertouch)
 PitchWhl (Pitch Wheel)
 ModWhl (Modulation Wheel)
 Pedal
 MIDI Volume (Controller 7)
 MIDI Pan (Controller 10)
 MIDI Expression (Controller 11)
 MIDI A-P
 PLAGout (Preset Lag Out)
 PRampOut (Preset Ramp Out)
 FootSw1 - 3 (Foot Switch 1-3)
 FootFF (Flip-Flop Foot Switch 1 -3)
 Key Glide
 VolEnv +, ±, < (Volume Envelope)
 FilEnv +, ±, < (Filter Envelope)
 AuxEnv +, ±, < (Auxiliary Envelope)
 LFO 1 & 2 (+, ±)
 White (White Noise)
 Pink (Pink Noise)
 XfdRand (Crossfade Random)
 KeyRand 1 & 2 (Key Random)
 Lag 0 sum (summing amp out)
 Lag 1 sum (summing amp out)
 Lag 0 & 1 (Lag Processor)
 Clk Divisors (Octal, Quad, Double
 Whole, Whole, Half, Qtr, 8th,16th)
 DC (DC Offset)
 Summing Amp
 Switch
 Absolute Value
 Diode
 Flip-Flop
 Quantizer
 4x Gain

Modulation Destinations

Off
 KeySust (Key Sustain)
 FinePtch (Fine Pitch)
 Pitch
 Glide
 ChrsAmt (Chorus Amount)
 'SStart (Sample Start) -note-on)
 SLoop (Sample Loop)
 SRetrig (Sample Retrigger)
 FiltFreq (Filter Frequency)
 'FiltRes (Filter Resonance -note-on)
 AmpVol (Amplifier Volume)
 AmpPan (Amplifier Pan)
 RTXfade (Real-time Crossfade)
 VEnvRts (Volume Envelope Rates -all)
 VEnvAtk (Volume Envelope Attack)
 VEnvDcy (Volume Envelope Decay)
 VEnvSus (Volume Envelope Sustain)
 VEnvRls (Volume Envelope Release)
 FEnvRts (Filter Envelope Rates -all)
 FEnvAtk (Filter Envelope Attack)
 FEnvDcy (Filter Envelope Decay)
 FEnvSus (Filter Envelope Sustain)
 FEnvRls (Filter Envelope Release)
 FEnvTrig (Filter Envelope Trigger)
 AEnvRts (Auxiliary Envelope Rates -all)
 AEnvAtk (Auxiliary Envelope Attack)
 AEnvDcy (Auxiliary Envelope Decay)
 AEnvSus (Auxiliary Envelope Sustain)
 AEnvRls (Auxiliary Envelope Release)
 AEnvTrig (Auxiliary Envelope Trigger)
 LFO 1 & 2 Rate
 LFO 1 & 2 Trigger
 Lag Processor In 0 & 1
 Sum (Summing Amp)
 Switch
 Abs (Absolute Value)
 Diode
 Quantize
 Flip-Flop
 Gain 4x
 Cord 1-24 Amount

Note: Flip-Flop Footswitches 1 & 2 remain in their last condition when a new preset is selected.

Flip-Flop Footswitch 3 resets to the Off condition whenever a new preset is selected.

Note: The Envelope Sustain parameter controls the Decay 2 Level segment of the envelope generator.

Pitch Bend Range

Specifies the Pitch Wheel range in semitones for the current layer. Pitch Wheel is a standard synthesizer control which is transmitted as a MIDI continuous controller message used (normally) to bend the pitch up and down.

The PitchBend range is from 0 to ± 12 semitones or "Master." A setting of "0" turns the pitch wheel Off for the current layer. The Master setting uses the Pitch Bend range defined in the *Global menu*.



Mix Output

This feature allows you to program the Effect Send as a part of the preset. Note that for this feature to work, the Mix Output setting in the Global menu MUST be set to "Preset" on the selected MIDI channel. If you want to define output routing by MIDI channel, set it up using the Mix Output page in the Global menu. See "Mix Output" on page 86 for more information.

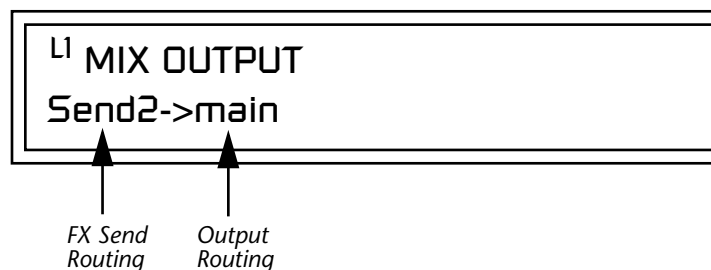

The Sends function as effect processor inputs (effect sends). The Output Routing field shows the true routing of the Sends to the Main output.

► To Control the Mix Output from the Preset:

1. Move the cursor until it is underneath the Layer field and change the Layer using the data entry control.
2. Move the cursor until it is underneath the FX Send Routing field and change the Send (1-4) using the data entry control.
3. Locate the MIX OUTPUT screen in the Global menu.
4. Set the MIDI channel you are using to "use preset".

Common Preset Parameters

Presets Effects

This section of the Preset Edit menu chapter describes parameters that affect all layers in the preset.

XK-6 has two stereo effects processors. When playing presets one at a time, the two processors can be programmed as part of the preset. The diagram below shows how the effects are integrated into the signal path using a parallel effects send/return model, similar to a mixing console.

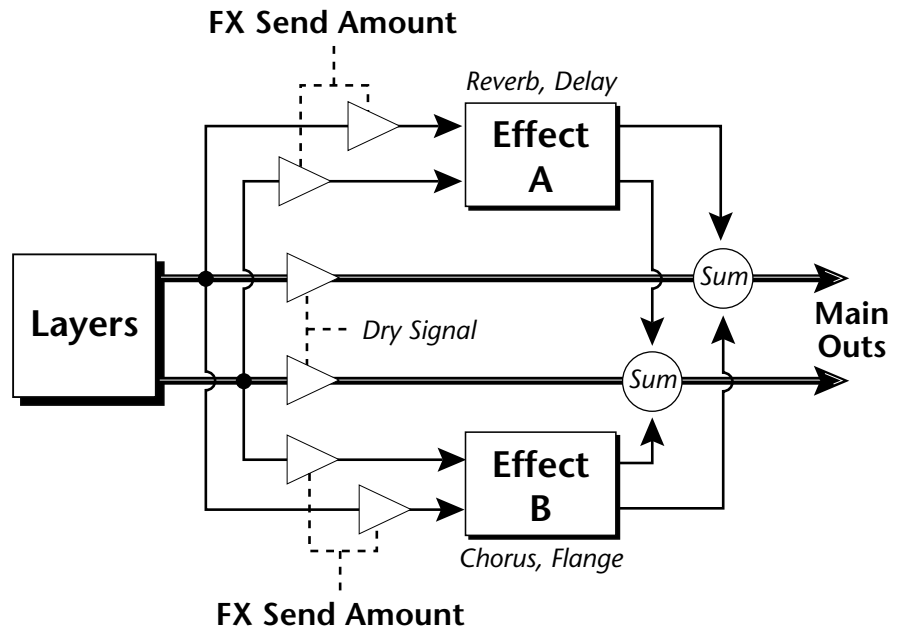

Refer to the Effects chapter for additional information and instructions for setting up both the Preset Effects and the Master Effects.

OUTPUT SECTION & EFFECTS PROCESSORS

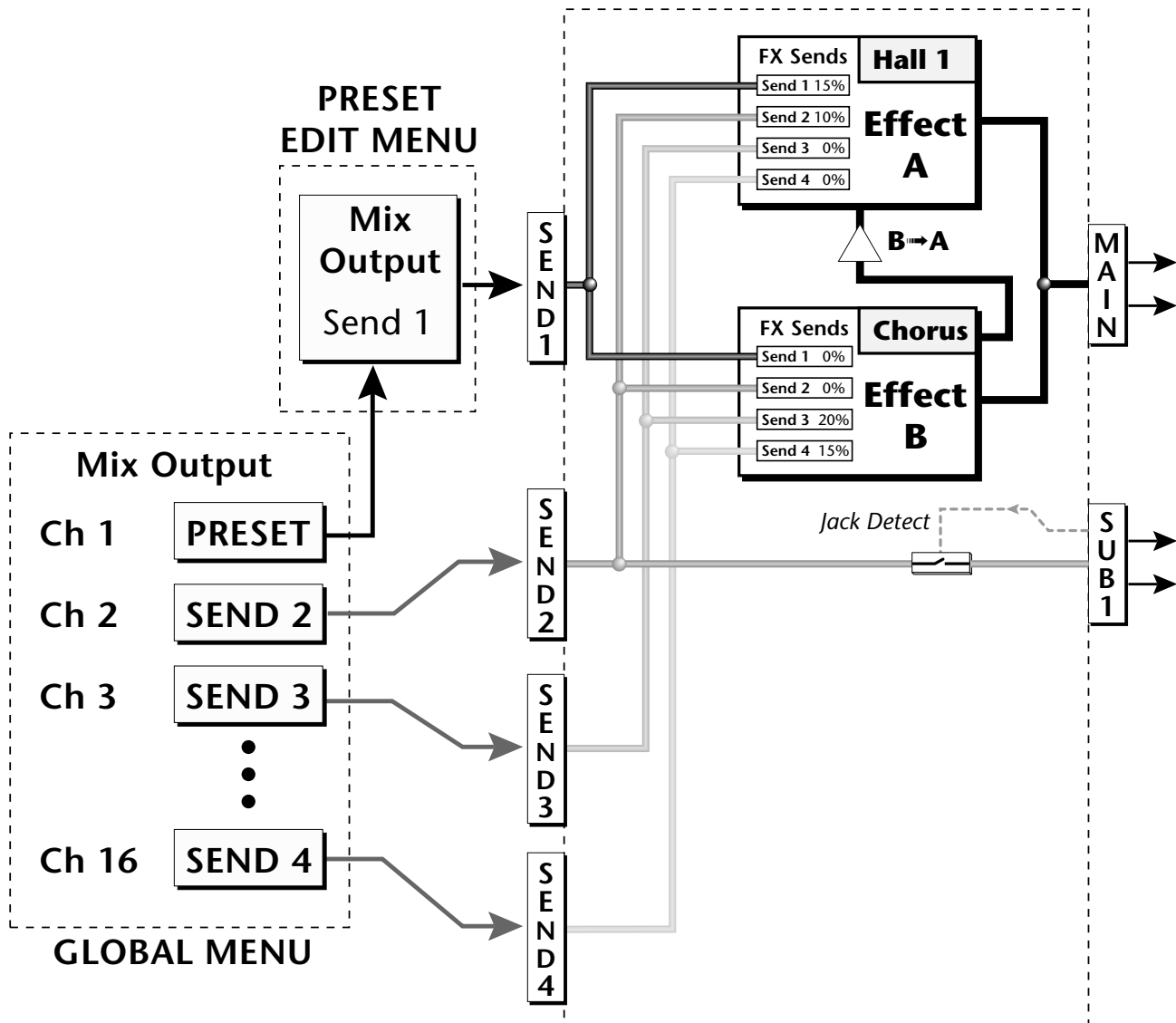

The Mix Output setting in the Global Menu determines if the Preset's Mix Output routing will be used. This allows the Sends to be programmed by either **MIDI Channel** or by **Preset**, whichever you prefer.

FXA Algorithm

This screen selects the effect type for Effect Processor A. The “A” effects consist of different reverb types and digital delays. Move the cursor to the lower line of the display and select the effect you want.

FXA ALGORITHM
Lg Concert Pan

A Effect Types

1. Room 1
2. Room 2
3. Room 3
4. Hall 1
5. Hall 2
6. Plate
7. Delay
8. Panning Delay
9. Multitap 1
10. Multitap Pan
11. 3 Tap
12. 3 Tap Pan
13. Soft Room
14. Warm Room
15. Perfect Room
16. Tiled Room
17. Hard Plate
18. Warm Hall
19. Spacious Hall
20. Bright Hall
21. Bright Hall Pan
22. Bright Plate
23. BBall Court
24. Gymnasium
25. Cavern
26. Concert 9
27. Concert 10 Pan
28. Reverse Gate
29. Gate 2
30. Gate Pan
31. Concert 11
32. Medium Concert
33. Large Concert
34. Large Concert Pan
35. Canyon
36. DelayVerb 1
37. DelayVerb 2
38. DelayVerb 3
39. DelayVerb 4 Pan
40. DelayVerb 5 Pan
41. DelayVerb 6
42. DelayVerb 7
43. DelayVerb 8
44. DelayVerb 9

FXA Parameters

The FXA parameters are Decay, High Frequency Damping, and the FxB to FxA send. **Decay** sets the length of time it takes an effect to fade out. **HF Damping** causes the high frequency energy to fade away more quickly during the reverb decay. **FxB to FxA** controls the amount of the “B” effect sent through effect “A”. This allows you to place the two effects in series and create setups such as “distortion through reverb” among others. Please refer to the Effects chapter for more information about the effects.

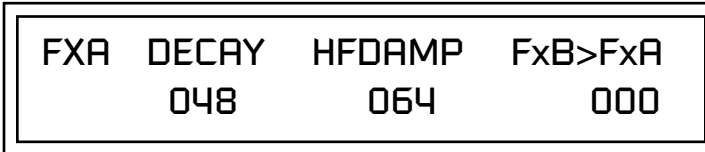

FXA Send Amounts

These parameters set the effects amounts for each of the four stereo effects busses.

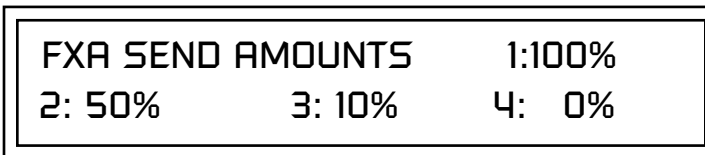

FXB Algorithm

This screen selects the effect type for Effect Processor A. Move the cursor to the lower line of the display and select the effect you want.



B Effect Types

- | | | |
|--------------|--------------------|-----------------------|
| 1. Chorus 1 | 12. Flange 5 | 23. PanDelay Chorus 1 |
| 2. Chorus 2 | 13. Flange 6 | 24. PanDelay Chorus 2 |
| 3. Chorus 3 | 14. Flange 7 | 25. Dual Tap 1/3 |
| 4. Chorus 4 | 15. Big Chorus | 26. Dual Tap 1/4 |
| 5. Chorus 5 | 16. Symphonic | 27. Vibrato |
| 6. Doubling | 17. Ensemble | 28. Distortion 1 |
| 7. Slapback | 18. Delay | 29. Distortion 2 |
| 8. Flange 1 | 19. Delay Stereo | 30. Distorted Flange |
| 9. Flange 2 | 20. Delay Stereo 2 | 31. Distorted Chorus |
| 10. Flange 3 | 21. Panning Delay | 32. Distorted Double |
| 11. Flange 4 | 22. Delay Chorus | |

FXB Parameters

The FXB parameters are Feedback, LFO Rate and Delay. **Feedback** sends the output of the effect back into the input. This creates multiple echoes on a delay effect and intensifies a chorus or flange effect. **LFO Rate** allows you to change the speed of the modulation oscillator for flange and chorus effects. **Delay** sets the length of the delay line. This affects the time between echoes, or the tone of flange effects.

FXB	FEEDBK	LFORATE	DELAY
	032	003	200ms

FXB Send Amounts

These parameters set the effects amounts for the four stereo effects busses.

FXB SEND AMOUNTS	1: 100%
2: 50%	3: 10%
	4: 0%

Preset Patchcords

Preset PatchCords give you real-time control of global parameters. The effect processors are a powerful synthesis tool and this feature lets you control and use them in exciting new ways. For example, you can dynamically adjust the effects mix during a sequence or live performance.

There are many exciting performance possibilities using Preset PatchCords to control Arpeggiator parameters and Effects Sends. The front panel knobs 15 & 16 are usually connected to Arp parameters in factory presets marked "arp:" Be sure to try out these controls

There are 12 Preset PatchCords per preset with a source, a destination and an amount control. The amount can be set from -100 to +100. The Preset PatchCord controls are **added** to the FX Send Amounts set in the Global or Preset Edit menus. In other words, multiple sources connected to destinations are **summed**.



To crossfade between effects.

- 1) Set FXA Send 1 to 100%.
- 2) Set FXB Send 1 to 0%.
- 3) Set FX Cord #1 to FXA Send 1 at -100.
- 4) Set FX Cord #2 to FXB Send 1 at +100.

Increasing the controller amount will crossfade from FXA to FXB.

PRESET CORDS	#01
Pedal -> FXBSend2	+100

Modulation Sources:

Off
PitchWhl (Pitch Wheel)
ModWhl (Modulation Wheel)
Pedal
MIDI Volume (Controller 7)
MIDI Pan (Controller 10)
MIDI A-L
Footswitch 1
Flip-Flop Footswitch 1
Footswitch 2
Flip-Flop Footswitch 2
Footswitch 3
Flip-Flop Footswitch 3
DC

Modulation Destinations

Off
Effect A Send 1
Effect A Send 2
Effect A Send 3
Effect A Send 4
Effect B Send 1
Effect B Send 2
Effect B Send 3
Effect B Send 4
Preset Lag In
Preset Lag Amount
Preset Lag Rate
Preset Ramp Rate
Arp Resolution
Arp Extension
Arp Velocity
Arp Gate
Arp Interval
Beats Velocity, Group 1-4
Beats Transpose (Xps), Group 1-4
Beats Busy
Beats Variation

Initial Controller Amount

This parameter sets the initial value of MIDI controllers A-P when the preset is first selected. The front panel Control Knobs can be thought of as front panel MIDI controllers because in the XK-6, they are treated just as if they originated from an external MIDI device. Refer to the following diagram. There are 4 Initial Controller Amount screens (A-D, E-H, I-L, M-P).

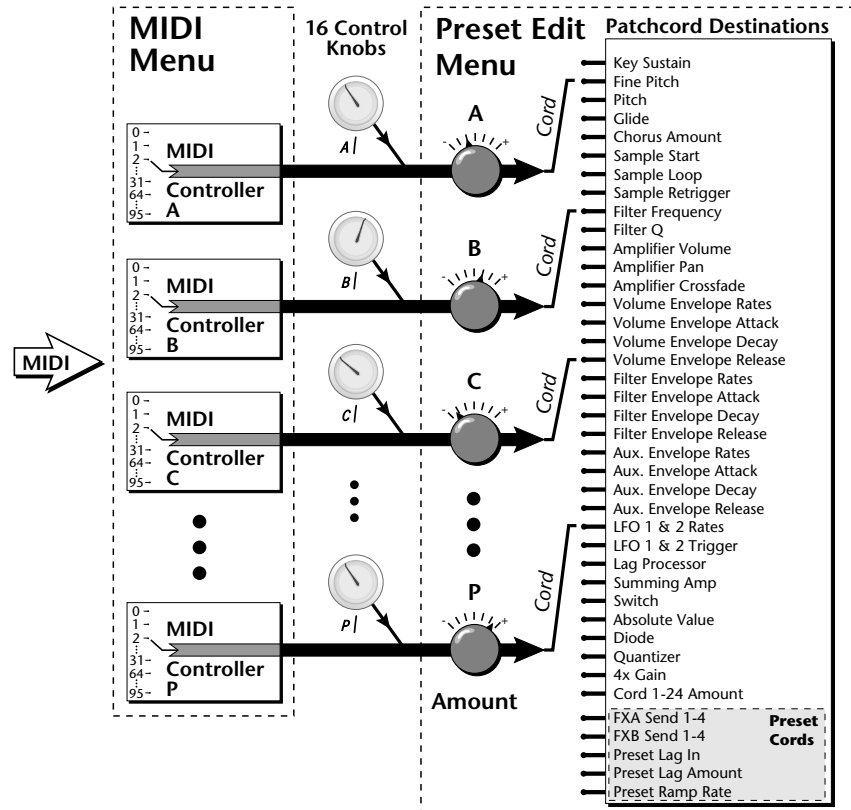

External MIDI controller numbers are assigned to the Letters A-P in the MIDI menu. The Initial Controller Amount value is sent to the PatchCord destination when the Preset is first selected. If you move the Control Knob, then that value replaces the initial value. If MIDI controller data is received it will similarly replace the knob or initial setting.

INITIAL CONTROLLER AMT

A:017 B:112 C:127 D: off

The Initial controller amounts can be set from 000-127 or they can be turned Off. If set to Off, the current controller value is used when the preset is first selected. Setting the Initial Amount to "off" uses the values from the previously selected preset.

Keyboard Tuning

In addition to the standard equally divided octave tuning, XK-6 contains twelve factory programmed tunings and 12 user-definable tunings. The Keyboard Tuning parameter selects which tuning is used by the current preset. The User Tuning tables are defined in the Global menu.

The factory Keyboard Tuning tables are described in the following table.

Tuning Tables	Description
Equal Temperament	Standard Western tuning (12 equally spaced notes per octave)
Just C	Just intonation. (Based on small interval ratios. Sweet and pure, non-beating intervals.)
Vallotti	Valotti & Young non-equal temperament. (Similar to 12 tone equal temperament. Each key has a different character for a given scale.)
19-Tone	19 tone equal temperament. (19 notes per octave. Difficult to play, but works well with a sequencer.)
Gamelan	5 tone Slendro and 7 tone Pelog. (Javanese. Pelog are white keys, Slendro are black keys. Exotic tunings of Gamelan flavor.)
Just C2	Allows you to play the following chords in the key of C: C, E, F, G, A, B, C#m, D#m, Em, F#m, G#m, Am, Bm
Just C-minor	Allows you to play the following chords in the key of C: C, E, F, G, A, B, Em, Am, Bm, C#m, D#m, G#m
Just C3	Allows you to play the following chords in the key of C: C, D, F, Bb, C#m, Dm, Em, F#m, G#m, Am
Werkmeister III	A "well" temperament developed in the 17th century. Although you can play in all keys, each key sounds slightly different.
Kirnberger	Another well temperament developed by Johann Philipp Kirnberger where no pitch is more than 12 cents off from equal temperament.
Scarlatti	A variant of Meantone tuning which was used from the 15th to 18th centuries.
Repeating Octave	Middle C octave is repeated up and down the keyboard. Link with a preset in equal temperament to form unusual inversion up and down the keyboard.
User 1-12	Define your own tuning tables (<i>Global menu</i>).

Refer to "User Key Tuning" on page 92 in the Global Menu chapter for instructions on how to define your own Keyboard Tunings.



XK-6 implements the MIDI Tuning Dump protocol which allows you to create tuning tables on your personal computer and download them via MIDI. There are several computer applications available on the internet which let you create and download tuning tables via MIDI.

The Just C Tuning Tables

Well Tempered and Just were standard keyboard tunings up until the 20th-century when the current “equal tempered” scale became prevalent. In an equal tempered scale, the octave is equally divided into 12 parts. In Just or Well Tempered scales, the 12 notes are separately tuned to produce pure chords. However, in Just tunings you are limited to playing certain chords and if you play the wrong chord it may sound very BAD!

XK-6 allows you to modulate between keys by providing you 12 user tuning tables. Tuning tables can be changed as you play using a program change (create several presets with the same sound and different tuning tables), by MIDI SysEx command (using a programmable MIDI footswitch or other device), or using a continuous controller (link 2 presets and crossfade between them using a controller).

The Just C2, Just C min, Just C3 Tuning Tables

These new tuning tables take the concept of just intonation a step beyond previous E-MU products. Fully explaining the mysteries of just intonation is beyond the scope of this manual, but the subject is covered exhaustively in Hermann Helmholtz's On the Sensations of Tone, available at most libraries and bookstores.

The new tables are called Just C2, Just C3, and Just C Minor. Try playing in the key of C/Cm using each table. You'll quickly discover both the wonders and the frustrations of just intonation! In Just C, for example, you'll find that the chords C, Em, F, G, and Am sound beautiful. If you hold one of these chords, you'll hear no “beating”. After playing for a few minutes, switch back to Equal Temperament for a rude awakening!

At this point you might wonder why anyone would use Equal Temperament to begin with. For the answer to that question, play a D, Dmi, or Bb chord!.The intervallic ratios that make the C & G chords sound so pure make the D chord sound horribly out of tune. That's why we had to include Just C3. In this tuning, D, Dmi and Bb sound in tune, but the G chord will sound wrong.

Each of the 4 tables allows you to play a different group of common chords in just intonation. Sadly, there is no single 12 note tuning that will allow all of the common chords to be in tune, and of course that's why they invented the equal temperament tuning system that we use today.

Just C

Play these chords: C, E, F, G, A, Cm, C#m, Em, F#m, Gm, Am

Just C2

Play these chords: C, E, F, G, A, B, C#m, D#m, Em, G#m, Am, Bm

Just C2 minor

Play these chords: C, D^b, D, E^b, G, A^b, Cm, Em, Fm, Gm

Just C3

Play these chords: C, D, F, B^b, C#m, Dm, Em, F#m, G#m, Am

Preset Links

You can link presets to other presets to create layering or keyboard splits. The current preset can be linked with up to two other presets (Links 1 & 2). Each linked preset can be assigned to a specific range in order to create keyboard splits or can be assigned a velocity range to switch links according to key velocity. In addition, you can specify Volume, Pan, Transpose and Delay settings for each Link. The modulation parameters specified in each preset remain in effect for each preset in the link.

LINK 1 Preset	XROM
000 ² Preset Name	

LINK 1	KEY	VEL
RANGE	C-2	G8
		000-127

LINK 1	VOLUME	PAN
	+0dB	00

LINK 1	TRANSPOSE	DELAY
	+00	0

Links provide an easy way to create new sounds by combining the existing presets. Or, you can create your own custom stacked presets with up to 12 layers! We're talking LARGE sounds here. Of course Links can also be used when you just want to stack up two sounds.

As an example, let's stack two presets to create a big sound. Start with a preset you like, then go into the Links screen and start scrolling through the preset list while you play to hear both presets together. When you find a winner, simply Save the preset and you're finished!

- You can "Split" the keyboard up to 12 ways by using combinations of the Layers and Links.
- By adjusting the Velocity for the link, you can bring in the link by playing hard.
- Transposing the Link can radically change the sound.
- The delay parameter lets you create surprise effects, echoes or cascades of sound as you continue to hold the keys.

Preset Tempo Offset

This function allows you to double or halve the Master Tempo as it applies to this preset. When playing or sequencing several presets in Multi mode, the Master Tempo may be too fast or slow for one preset. Using this feature, you can adjust the tempo for the misbehaving preset. The Tempo Offset can use the **current tempo** or be set to **half** or **twice** the current tempo.

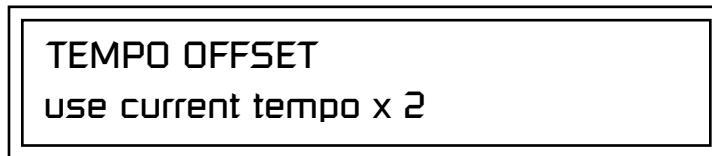

Audition Riff Selection



Listening to the Riffs is a quick way to learn the sounds in XK-6. If a preset has hidden tricks or controllers, these will be shown off in the Riff.

A Riff is a short pre-recorded musical phrase which can be anything from a single note to a full 16-track sequence. This function allows you to assign a Riff to a Preset. The Preset Riff will be used when the front panel Audition button is pressed.

The Riffs themselves cannot be modified.

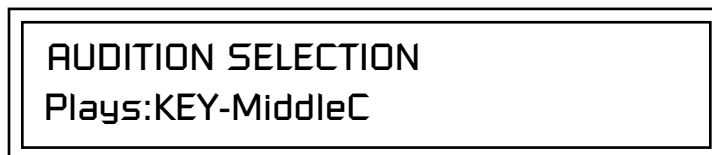

Play Solo Layers

When constructing multilayer sounds it is often useful to turn off one or more of the layers so you can hear what you're doing! This feature allows you to temporarily solo individual layers or listen to them in any combination. This screen differs from the other Preset Edit screens in that it is NOT saved with the preset. The values reset each time you exit the Preset Edit menu.

Solo is activated by setting any layer to On (On = the layer is being Soloed). Any layers set to **On will play** and any layers set to **Off will be muted**. If all layers are set to Off, then Solo mode ends and all layers play normally. When you exit the Preset Edit menu, all layers play normally.

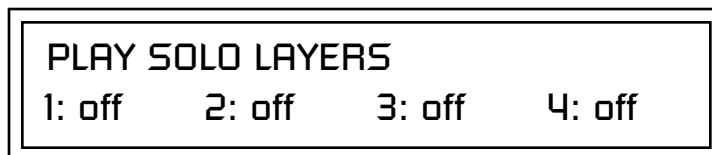



Effects

Effects Overview

XK-6 has two stereo effects processors. When playing presets one at a time, the two processors can be programmed as part of the preset. When the MIDI Mode is set to “multi,” the XK-6 uses a global effects assignment (Master Effects). The diagram below shows how the effects are integrated into the signal path using a parallel effects send/return model, similar to a mixing console.

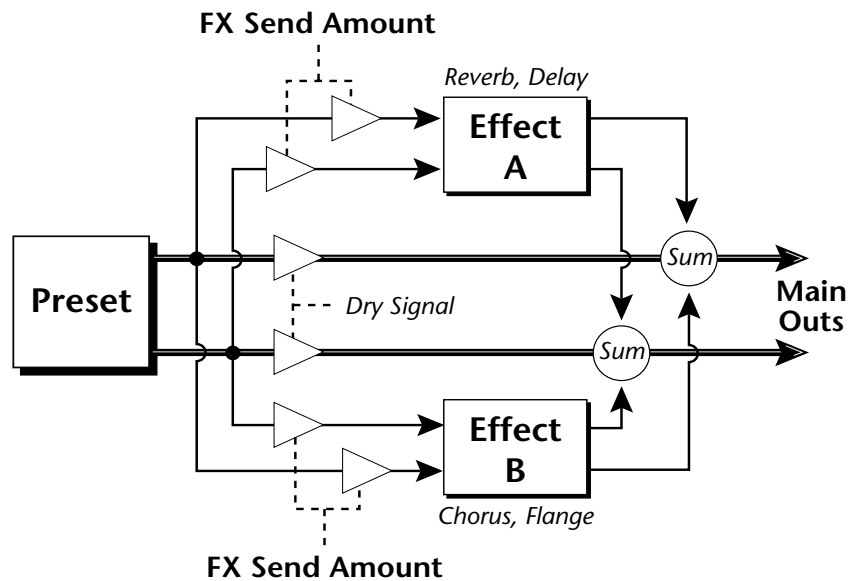

The Effects Sends

On a mixing console you can control the amount of signal each channel sends to the effect bus. This allows each channel to be placed in a slightly different “sonic space” which creates an airy, open sound.

XK-6 uses this basic concept, but works in a slightly different manner. There are four effects busses: Send1-Send4. Each preset or each MIDI channel (you determine which), can be directed to one of the four busses. Each effect processor has four Send Amounts which allow you to set the wet/dry mix on each of the four busses going into the effect. A setting of 0% is completely dry (no effect). A setting of 50% contains an equal mix of affected and normal (dry) signal.

Send 2 is also used to route sounds to the Sub 1 outputs on the back panel. When a plug is inserted into the associated Submix jack on the back panel, the Dry portion of the Send is disconnected from the effects processor and the Dry signal is routed directly to the output jack. **The Arrow (->) in the display points to the actual output routing.** *The Dry Send is disconnected from the Effects Processors even if only one plug is inserted into a Submix pair.*

The Effects Send is programmed for each layer in the Preset Edit menu. These routings can be overruled in the Global menu *Mix Output* screen by changing the submix setting from “preset”, which uses the preset routing, to Send1-Send4. In the diagram below, MIDI channel 1 is programmed to obey the preset routing, which in this case is Send 1.

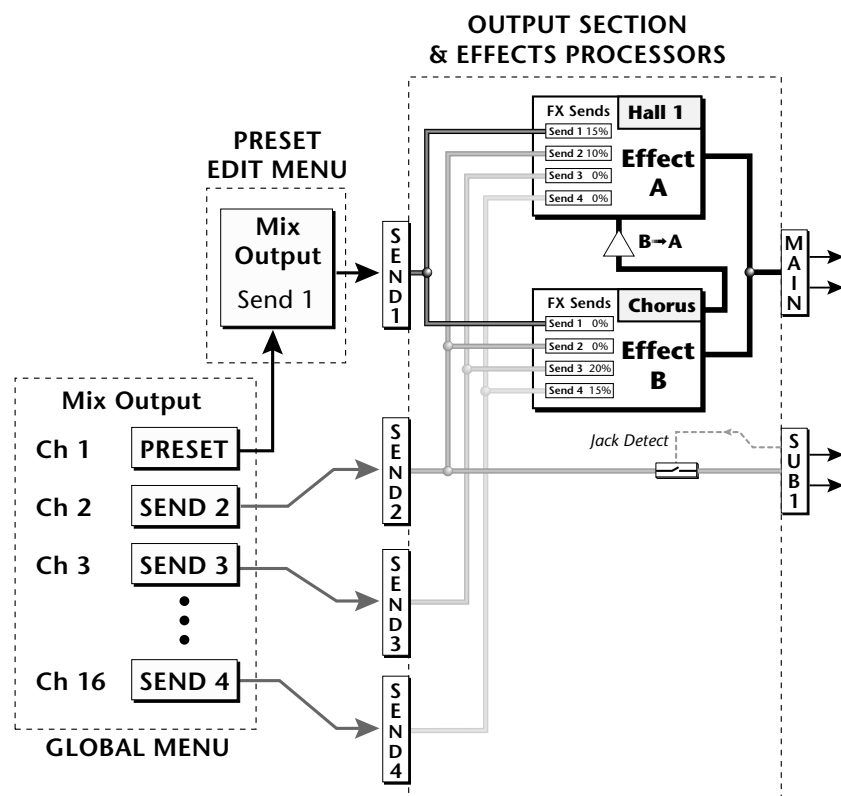

Individual layers or entire MIDI channels can be routed to any of the four busses.

The four Effect Sends allow you to get the most out of the two effect processors. For example, with Effect B set to an echo algorithm, you could route one MIDI channel to Send 3 and set the effect amount to 80%. Another MIDI channel could be routed to Send 4 with an effect amount of only 5%.

The Mix Output function is also useful when sequencing since it lets you route specific MIDI channels to specific Sub outputs (on the back panel) where there they can be processed with EQ or other outboard effects.

Effect Types

A Effect Types

Room 1-3
Hall 1 & 2
Plate
Delay
Panning Delay
Multitap 1
Multitap Pan
3 Tap
3 Tap Pan
Soft Room
Warm Room
Perfect Room
Tiled Room
Hard Plate
Warm Hall
Spacious Hall
Bright Hall
Bright Hall Pan
Bright Plate
BBall Court
Gymnasium
Cavern
Concert 9
Concert 10 Pan
Reverse Gate
Gate 2
Gate Pan
Concert 11

Medium Concert
Large Concert
Large Concert Pan
Canyon
DelayVerb 1-3
DelayVerb 4-5 Pan
DelayVerb 6-9

B Effect Types

Chorus 1-5
Doubling
Slapback
Flange 1-7
Big Chorus
Symphonic
Ensemble
Delay
Delay Stereo
Delay Stereo 2
Panning Delay
Delay Chorus
Pan Delay Chorus 1 & 2
Dual Tap 1/3
Dual Tap 1/4
Vibrato
Distortion 1 & 2
Distorted Flange
Distorted Chorus
Distorted Double

Effect Parameters

“A” Effect types contain Reverb and Delay effects. “B” Effect types contain Chorus, Flange and Distortion effects. There are 44 “A” effects and 32 “B” effects. In addition to the effect type, there are user adjustable parameters for each effect. The “A” effects have programmable Decay and High Frequency Damping. The “B” effects have user programmable Feedback, LFO Rate, and Delay Time.

Decay

The Decay parameter is used when setting “A” type effects. Decay sets the length of time it takes an effect to fade out. When setting up reverb effects, Decay controls the room size and the reflectivity of the room. For larger room sizes and greater reflectivity, set the Decay value higher. When setting up delay effects, the Decay parameter controls how many echoes are produced or how long the echoes last. The greater the value, the more echoes and longer lengths of time.

The Decay value range is from 0 through 90.

High Frequency Damping

The HF Damping parameter is used when setting “A” type effects. High Frequency energy tends to fade away first as a sound is dissipated in a room. The HF Damping parameter adjusts the amount of damping applied to the signal’s high frequency elements which, in turn, changes the characteristics of the room. Rooms with smooth, hard surfaces are more reflective and have less high frequency damping. Rooms filled with sound absorbing materials, such as curtains or people, have more high frequency damping.

The value range for High Frequency Damping is from 0 through 127.

Feedback

The Feedback parameter is used when setting “B” type effects. The Chorus and Flange effects have a controllable feedback loop after the delay element. Feeding back a small amount of the signal intensifies the effect by creating multiple cancellations or images. Higher feedback values increase the amount of the Feedback loop.

The Feedback value range is from 0 to 127.

LFO Rate

The LFO Rate parameter is used when setting “B” type effects. Both Chorus and Flange effects use a Low Frequency Oscillator (LFO) to animate the effect. LFO applied to a chorus effect creates the slight changes necessary for a realistic choral effect. Applied to a flanger effect, the LFO moves the comb filter notches and adds animation to the sound.

The LFO Rate value range is from 0 to 127.

Delay

Flanging, chorus and echoes are all based on a delay line where the signal is delayed by some time period and then mixed back with the unaltered signal. This parameter specifies the how much time passes before you hear the delayed signal. On some effects, this value cannot be changed. In this case, the field contains a dash.

The Delay value range is from 0ms to 635ms.

Effects Programmed in the Preset

Effects are normally programmed as part of the preset allowing you to have a different effect for each. This section describes how to program and modify XK-6's preset effects.

► To Program the Effects as Part of the Preset:

1. Press the Preset Edit button. The LED illuminates and the Preset Edit screen appears.
2. Use the data entry control to select the FXA Algorithm screen.



FXA ALGORITHM
Lg Concert Pan

3. Select an Effect. Do not select the "Master Effect" setting or the global effects set up in the Global menu will be used instead of the Preset Effect settings.
4. Use the data entry control to select the FXA parameter screen.



FXA	DECAY	HFDAMP	FxB>FxA
	90	127	127

The FxB -> FxA parameter lets you route the B effect through the A effect. See "Effect B Into Effect A" on page 182.

5. Set the other effect parameters to your preference. Refer to the information in the last section for detailed descriptions of these parameters.
6. Use the data entry control to select the FXB Algorithm screen.



FXB ALGORITHM
Distorted Flange

7. Select an Effect. Do not select the "Master Effect" setting or the global effects set up in the Global menu will be used instead of the Preset Effect settings.
8. Use the data entry control to select the FXB parameter screen.

Master Effects

FXB	FEEDBK	LFORATE	DELAY
	127	127	635ms

9. Set the other effect parameters to your preference. Refer to the information in the last section for detailed descriptions of these parameters.
10. Save the preset. The programmed effects setting will be saved along with the preset.

When playing single presets, the effects are normally programmed as part of the preset. In Multimode the Master effects are used, since there are only two effect processors to serve 16 MIDI channels.

You might also want the effects to be programmed on a global basis when in Omni or Poly modes. You could choose your favorite reverb, for example, and have it applied to any preset you select.

► To Program the Master Effects

1. Press the Global menu button. The LED illuminates and the Global screen appears.
2. Use the data entry control to select the FXA Algorithm screen.

FXA ALGORITHM
Lg Concert Pan

3. Select an Effect.
4. Use the data entry control to select the FXA parameter screen.

FXA	DECAY	HFDAMP	FxB>FxA
	90	127	127

The FxB -> FxA parameter lets you route the B effect through the A effect. See "Effect B Into Effect A" on page 182.

5. Set the other effect parameters to your preference. Refer to the information in the last section for detailed descriptions of these parameters.
6. Use the data entry control to select the FXB Algorithm screen.



7. Select an Effect.
8. Use the data entry control to select the FXB parameter screen.

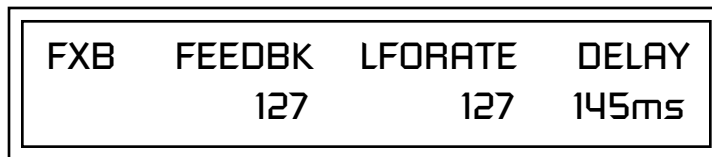

9. Set the other effect parameters to your preference. Refer to the information in the last section for detailed descriptions of these parameters.
10. Press the Preset Edit menu button. The LED illuminates and the Preset Edit menu displays the last screen used.
11. Use the data entry control to access the FXA Algorithm page and select "Master Effect A."



The MIDI mode (MIDI Menu) must be set to Omni or Poly mode in order to select the effects in the preset.



12. Repeat step 11 for the FXB Algorithm
13. Save the preset. The Master effects routing will be saved along with the preset.

Effects Mode

This control provides a true bypass of the effects engine. Bypass is a useful feature if you are using external effects at the mixing console and want to turn the effects off for all presets.

► To Bypass the Effects:

1. Press the Global menu button. The LED lights and the last Global parameter screen used is displayed.
2. Use the data entry control to select the Effects Mode screen.

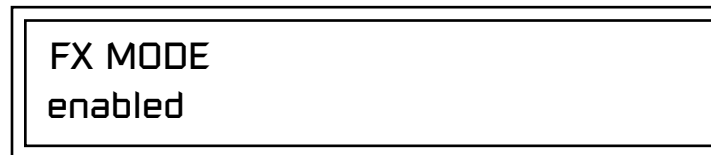

3. Use the cursor button to advance the cursor to the bottom line in the screen.
4. Use the data entry control to change the value.
5. Press the Enter key to save the settings.

The Effects Mode values are “enabled” and “bypassed.” Enabling the Effects Mode turns on effects. Selecting “bypassed” turns off the effects.

The effects processor controls are very flexible. The effects can be controlled in three different ways to suit your personal preference and to adapt to different situations.

When in Omni or Poly mode, effects are normally programmed as part of the preset. In Multi mode, the two effects processors can be controlled using the Master settings or by using the effects settings of a preset on a specific MIDI channel. Effects can be programmed in the following ways:

1. **Programmed as part of the preset when playing single presets (Omni or Poly Modes).**
2. **Programmed from the Master Effects Section when playing either single presets (preset Effect Type set to “Master”) or when in Multi Mode.**
3. **Programmed from the designated control preset when in Multi Mode.**

Flexible Effects Control



You can create special “Effects Presets” which are assigned to the FX Multi mode Control channel, then use standard MIDI Program Change commands to switch effects during sequence playback.

Refer to the following diagram for a look at how effects are programmed.

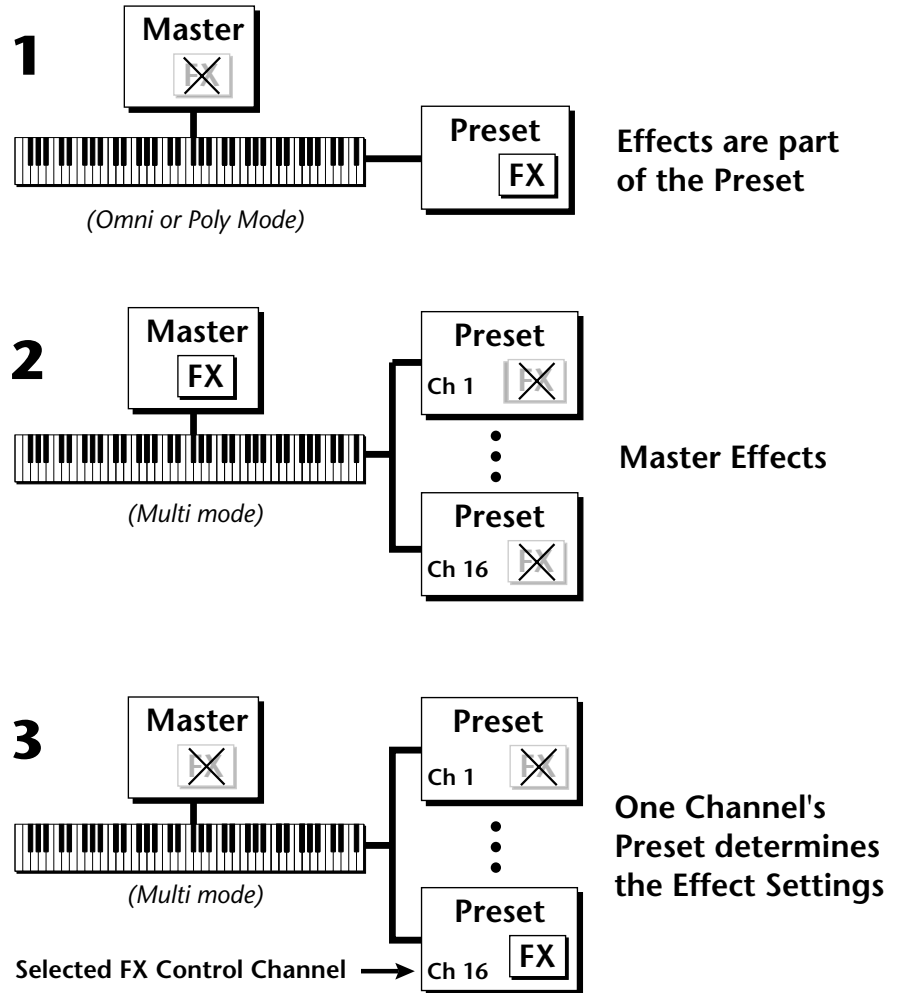

► **To Program the Effects Globally for all Presets in Multi Mode:**

1. Press the MIDI menu button. The LED illuminates and the MIDI menu screen appears.
2. Use the data entry control to select the MIDI mode page. Choose "multi" for the mode.

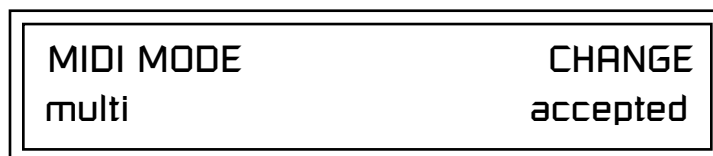

3. Move the cursor to the Multi mode Effects Control page using the data entry control.

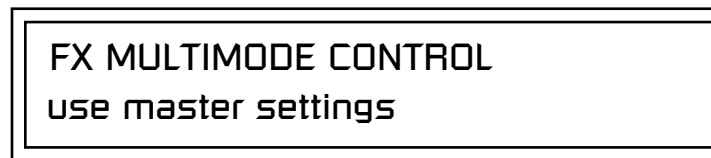

4. Set the Effect Control channel to *use master settings* using the data entry control.
5. Press the Enter key to save the settings and return to the main screen.

Using the Effects Channel Settings in Multi Mode

In Multi mode, the two effects processors can be controlled from the Master Effects settings or they can follow the effects settings of the preset on a special MIDI channel. The effect settings on this special channel will be applied to all the other MIDI channels. This allows the effects to be changed during a sequence simply by changing the preset on a specified MIDI channel.

► To Program the Effects by Channel Number in Multi Mode:

1. Press the MIDI menu button. The LED illuminates and the MIDI menu screen appears.
2. Use the data entry control to select the MIDI mode page. Choose “multi” for the mode.
3. Move the cursor to the Multi mode Effects Control field using the data entry control
4. Set the Effect Control to “preset on Channel #” (where # is replaced by the actual channel number from 1 through 16) using the data entry control.
5. Press Enter to save the settings and return to the main screen.

Effect B Into Effect A

The output of effects processor B can be routed into effects processor A. This connects the effects in series instead of their normal parallel configuration. Two effects connected in series sound very different than the same two effects in parallel. For example, a chorus patched through reverb can turn a bland string section into a lush wall of sound. The B →A amount can also be controlled for even more flexibility.

► To Send the Output of Effect B through Effect A:

In this example, 100% of Effect B will be sent into Effect A.

1. Access the FXA parameter screen (in either the Global or Preset Edit menus) that contains the FXB →FXA parameter.

FXA	DECAY	HFDAMP	FxB>FxA
	127	127	127

- Set this amount to 127. Press the cursor button to return the cursor to the top line in the display.
- Use the data entry control to select the FXA submix routing parameter screen.

FXA SEND AMOUNTS	1: 10%
2: 20%	3: 30%
	4: 40%

- Press the cursor buttons to advance the cursor to the Main field.
- Set the Main send amount to any amount other than zero.
- Press the cursor button again to return the cursor to the FXA title. Use the data entry control to advance to the FXB Algorithm page.
- Select an effect.
- Advance to the FXB submix routing page and set the Main FXB send percentage to zero.
- Play the keyboard and you should hear the B Effect running through Effect A. This patch is shown below.

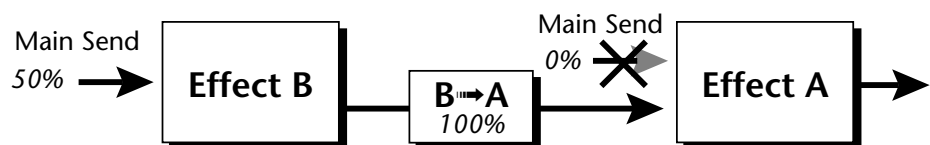

General Effect Descriptions

Reverb

Reverberation is a simulation of a natural space such as a room or hall. The reverb algorithms in XK-6 simulate various halls, rooms and reverberation plates. In addition, there are several other reverb effects such as Gated Reverbs, Multi Tap (early reflections), Delay and Panning effects. There are two adjustable parameters on the reverb effects - Decay Time and High Frequency Damping.

Decay time defines the time it takes for the reflected sound from the room to decay or die away. The diagram below shows a generalized reverberation envelope.

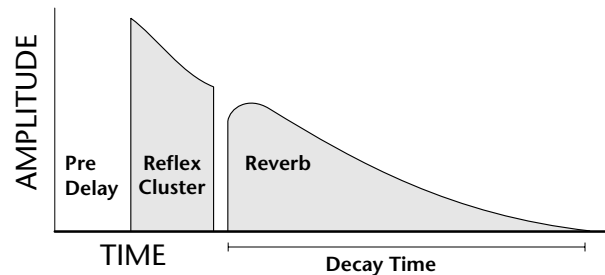

After an initial pre-delay period, the echoes from the closest walls or ceiling are heard. These first echoes, or the early reflection cluster, vary greatly depending on the type of room. Roughly 20 milliseconds after the early reflection cluster, the actual reverberation begins and decays according to the time set by the Decay Time parameter.

High frequency energy tends to fade away first as a sound is dissipated in a room. The High Frequency Damping parameter allows you adjust the amount of high frequency damping and thus change the characteristics of the room. Rooms with smooth, hard surfaces are more reflective and have less high frequency damping. Rooms filled with sound absorbing materials such as curtains or people have more high frequency damping.

General Descriptions of the Reverb Types

Room: Programs simulate small rooms with high frequency absorption caused by drapes and furniture.

Plates: Simulates plate type reverbs with their tight, dense, early reflections and sharp reverb buildup.

Hall: Presets recreate the open, spacious ambience of large concert halls.

Gated Reverbs: Add ambience only while the original signal is still sounding. As soon as the signal falls below a threshold, reverb is cut off.

Delay: Programs can be used to create echo and doubling effects.

Multi Tap: Programs consist of the reflection cluster only without the reverb decay.

Chorus

The function of a chorus device is to thicken the sound or to make one voice sound like many. This effect is usually created by mixing one or more delayed versions of the signal with the original. The delay times used are too short to be perceived as an echo, but long enough so that comb filtering does not occur. In addition, the delay time is varied via a low frequency oscillator to simulate the random differences which occur when multiple instruments are playing together. A slight amount of feedback improves the effect by creating multiple images of the sound as it recirculates again and again.

All the choruses are true stereo using two separate delay lines controlled by a single set of controls. The delay times are slightly different for each channel and the LFO phase is inverted on one channel to help contribute to the overall chorus effect. The LFO Rate and Depth settings are critical to achieving a realistic effect, with faster LFO rates generally requiring less LFO amount and vice-versa.

Doubling

When a copy of a sound delayed by about 26 milliseconds is added back to the original, two audio images are perceived by your brain. When the delayed image is slightly varied or modulated, the illusion of two voices is created.

Slapback

Slapback is a single short echo in the range of 50-60 milliseconds. A sound delayed by this length of time is perceived as a discrete and separate image which is useful for a thickening effect or as a pre-delay for reverb simulating a hard, reflective surface such a gymnasium wall.

Stereo Flanger

A flanger consists of a short audio delay line whose output is mixed together with the original signal. Mixing the delayed and original signals results in multiple frequency cancellations called a comb filter. Since the flanger is a type of filter, it works best with harmonically rich sounds.

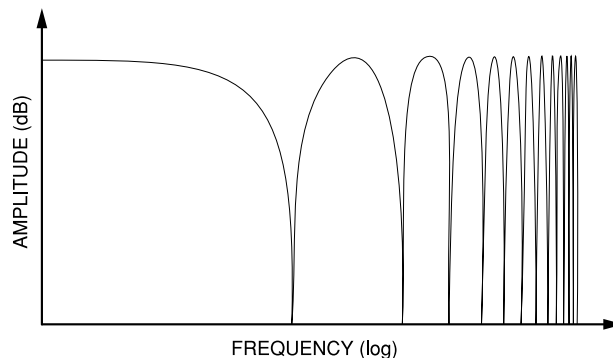

This is the frequency response of a Comb Filter.

Flanging was originally created using two tape recorders playing identical recordings. By exactly synchronizing the two decks and then slowing the speed of one by grasping the tape reel flanges, the flanging effect was born.

The XK-6 flanger is a stereo device consisting of two separate delay lines controlled by a single set of controls. A Low Frequency Oscillator (LFO) varies this initial delay setting, changing the frequency of the notches and adding animation to the sound. LFO Rate controls the rate of change and LFO Depth controls how much the LFO changes the delay.

The Feedback control sends some of the delayed signal through the delay line again. When feedback is used the comb filter notches are deepened.

Delay

Delay is an effect which can be used for doubling, reverb pre-delay, or echoes.

Delay Time is variable from 0-635 mS and controls the time between echoes. Feedback and determines how long the echoes continue sounding. "Infinite" delay effects are also possible without the risk of runaway.

Stereo Delay

Similar to delay except that the delay line outputs a stereo signal from the mono input. The two output signals are a few milliseconds apart to create a stereo image. The delay times are variable from 0-635 mS.

Panning Delay

A panning delay is similar to the normal delay lines except that the echoes bounce back and forth between the two stereo speakers.

Dual Tap

These are delay lines where the signal is "tapped off" at two unevenly spaced locations. When feedback is used, multiple complex echoes are produced. The fraction in some of the algorithm names (i.e. 1/3, 1/4) refers to the time ratio between the taps.

Vibrato

Basically, this a delay line modulated by an LFO, but with none of the original signal added in. The LFO modulation creates a Doppler shift and a resultant cyclical pitch shift. The vibrato created in this manner sounds very different than vibrato created by frequency modulating the sample.

Distortion

Distortion uses a technique called "soft-clipping" to create additional harmonics in the signal. As the level increases, the top of the waveform becomes somewhat squared. As the level increases further, it transforms into a true square wave.



Soft clipping gradually squares the edges of the waveform as the amplitude is increased.

Save/Copy Menu

Saving a Preset

The Save/Copy button is used to save changes to a preset, copy data between presets, randomize presets and to move other types of data. The menu is context-sensitive and will start at the appropriate save screen. If multiple items need to be saved, then the screens have the following priority: pattern, song, preset. Use the data entry control to navigate to other pages that support copying information.

Any time you make a change to a preset, either using the Preset Edit menu or by changing the Controller Knobs in Quick Edit mode, you must save the preset in order for the change to become permanent. When you save a preset it erases any existing preset information in that location. Make sure that the destination location does not contain preset information you want to keep.

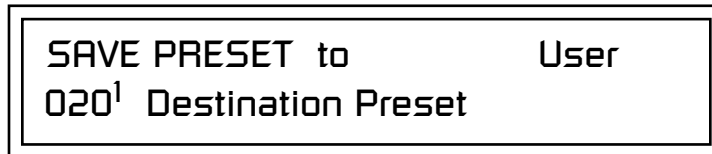

► To Save a Preset:

1. Press the **Save/Copy** menu button.
2. **Move the cursor** to the bottom line on the display.
3. **Select** the new preset location using the data entry control.
4. Press the **Home/Enter** button.

Copying Information

The Copy operations let you copy information from any preset or layer to any other preset or layer. To use the copy command, first select the preset or layer to which you want to copy (the destination location). Then, from the copy screen, select the preset or layer you want to copy to the currently selected location (the source location). Using the copy commands you can copy preset, layer, PatchCord and arpeggiator information.

Copy Preset

The Copy Preset command lets you copy all of the preset information from one location into the preset of the current location. The preset information in the source location (the preset location from which you want to copy) is not deleted from the original location, just copied to the destination location.

COPY PRESET from XROM1
009³ pad: Dreamer

► To Copy a Preset:

1. **Select the Preset** you want to copy information *into*.
2. Press the **Save/Copy** menu button.
3. Select “**Copy Preset from**” using the data entry control.
4. **Select the preset** you want to copy using the data entry control. The ROM Bank, Preset Number, Bank Number, Category and Preset Name fields are all selectable.
5. Press the **Home/Enter** button.
6. A warning appears asking you to confirm once more. Press the **Home/Enter** button to copy the selected preset into the current location.

 All the Sound Navigator features work when using the Copy functions.

Copy Layer

The Copy Layer command lets you copy any layer information from one preset into any layer of the current preset location. The layer information in the source location (the layer location from which you want to copy) is not deleted from the original location, just copied to the destination location.

COPY LAYER User L1 -> L4
020¹ Source Preset

Copy PatchCords

► To Copy a Layer:

1. Select the **Preset and Layer** you want to copy information *into*.
2. Press the **Save/Copy** menu button.
3. Move the cursor to the bottom line on the display.
4. Select the **preset location** using the data entry control, of the preset containing the information you want to copy into the current preset.
5. Move the cursor to the top line in the display.
6. Select the **layer** of the source preset in the first field on the right.
7. Select the **destination layer** in the second field.
8. Press the **Home/Enter** button.

The Copy Patch Cord command lets you copy the PatchCord settings from one layer of the preset location into the current layer of the current preset location. The preset information in the source location (the preset location from which you want to copy) is not deleted from the original location, just copied to the destination location.

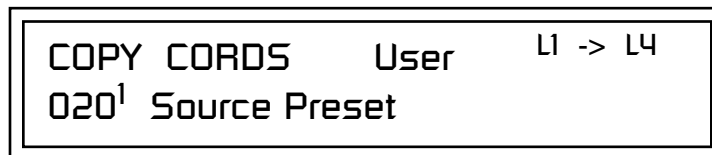

► To Copy a PatchCord:

1. Select the **Preset and Layer** you want to copy information *into*.
2. Press the **Save/Copy** menu button.
3. Move the cursor to the bottom line on the display.
4. Select the **preset location** using the data entry control, of the preset containing the information you want to copy into the current preset.
5. Move the cursor to the top line in the display.
6. Select the **layer** of the source preset in the first field on the right.
7. Select the **destination layer** in the second field.
8. Press the **Home/Enter** button.

Copy Preset PatchCords

The Copy Preset PatchCord command lets you copy the preset patchcord settings from one preset location into the current preset location. The preset information in the source location (the preset location from which you want to copy) is not deleted from the original location, just copied to the destination location.

```
COPY PRESET CORDS      User
0201 Source Preset
```

► To Copy a Preset PatchCord:

1. Select the Preset you want to copy information *into*.
2. Press the **Save/Copy** menu button.
3. Move the cursor to the bottom line on the display.
4. Select the preset containing the information you want to copy.
5. Press the **Home/Enter** button.

Copy Arpeggiator Settings

This function lets you copy the Arpeggiator settings from any ROM or RAM preset location into the current RAM (User) preset.

```
COPY ARP SET from  XROM1
0520 syn: Syn Chaos
```

► To Copy the Arpeggiator Settings:

1. From the Main display, select the User Preset you want to copy the Arp setting *into*.
2. Press the **Save/Copy** menu button.
3. Move the cursor to any of the fields on the bottom line on the display.
4. Use the data entry control to **select the preset** you want to copy *from*.
5. Press **Enter** when you have made your selection. *The Enter LED is flashing indicating that XK-6 is waiting for your response.*
6. The Arp Settings are copied into the current preset.

Copy Arpeggiator Pattern

This function lets you copy the Arpeggiator pattern from any ROM or RAM preset to any RAM (user) pattern.



COPY ARP PAT from XROM1
96¹ TRANCED

► To Copy the Arpeggiator Pattern:

1. Press the **Save/Copy** menu button.
2. Move the cursor to any of the fields on the bottom line on the display.
3. Use the data entry control to **select the preset** you want to copy *from*.
4. Press **Enter** when you have made your selection.



Overwrite pattern:
00⁰ No Control

5. Press **Enter**. The Arpeggiator Pattern is copied into the selected User Pattern.

Copy Preset Bank

The Copy Preset Bank command lets you copy an entire bank from any ROM or RAM bank location to any RAM (user) bank. This function can be especially useful after installing a new sound SIMM.

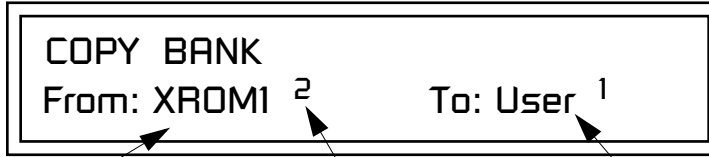

COPY BANK
From: XROM1 2 To: User 1

ROM or RAM Preset Location Bank No. Destination Bank No.

► To Copy a Preset Bank:

1. Press the **Save/Copy** menu button.
2. Move the cursor to the “**From**” field on the bottom line on the display.
3. Use the data entry control to **select the preset bank** you want to copy *from*.
4. Move the cursor to the “**To**” field on the bottom line on the display.
5. Use the data entry control to **select the User preset bank** you want to copy *into*.
6. Press the **Home/Enter** button to overwrite the bank.

Sound Authoring

Copy User Bank to Flash



If there is no Flash SIMM in the unit, the error message, "Requires Flash SIMM" will be displayed.

This is a special purpose function to be used with the Flash sound authoring feature. Flash Sound SIMMs created on an EOS Ultra sampler can be used as a custom XK-6 bank. Presets are then created in a User bank. When the bank of presets is finished, it can be copied, using this function, to the Flash SIMM. Flash SIMMs contain two separate memory locations. One of these memories contains the sound samples and the other memory can hold four banks of 128 presets.

For instructions on how to remove and replace ROM SIMMs, please see "Installing Sound SIMMs" on page 237.

The four sound SIMM sockets in XK-6 are marked 0-3. **The destination Flash SIMM must be placed in SIMM socket 1.**

COPY USER BANK TO FLASH
From: User⁰ To: Flash²

► To Copy a User Bank to Flash:

1. Make sure a Flash SIMM is inserted into the extra XK-6 SIMM socket.
2. Press the **Save/Copy** menu button.
3. Rotate the data entry control to select the "Copy User Bank" function shown above.
4. Move the cursor to the "From" field and select the User bank that you want to copy to the Flash SIMM.
5. Move the cursor to the "To" field and select the Flash bank that you want to contain the User bank.
6. Press **Enter**. The Enter LED will flash and the screen below appears.

Press ENTER to Overwrite
Flash SIMM Presets

7. Press **Enter** again to confirm. The following screen appears:

COPYING USER BANK TO FLASH
Done. Please Reboot Now.

8. The Flash presets cannot be used until XK-6 is rebooted (power off then on). **Reboot** the XK-6 and verify that the new Flash bank has been properly copied.

Rename Flash SIMM

 The Flash ID is the MSB of the MIDI Bank Select command used to select the Sound Bank.

 If there is no Flash SIMM in the unit, the error message, "Requires Flash SIMM" will be displayed.

This utility allows you to rename the Flash SIMM and change its ID number. Flash SIMMs can have any five letter name you choose. Each Flash SIMM in a XK-6 unit must have a unique ID number (106-119).

The field in the upper right corner selects between multiple Flash SIMMs. If only one Flash SIMM is installed, the field cannot be modified.

RENAME FLASH SIMM	Flash
New Name: Drums	ID: 110

1. Make sure a Flash SIMM is inserted in a XK-6 SIMM socket.
2. Press the **Save/Copy** menu button.
3. Rotate the data entry control to select the "Rename Flash SIMM" function shown above.
4. Move the cursor to the "New Name" field and rename the SIMM using the data entry control to select the letter and the cursor keys to select the position.
5. **Set the Sound ID number** for the SIMM. It doesn't matter which number you choose as long as the same number isn't used in another SIMM.
6. Press **Enter**. The following screen appears and the Enter LED will be flashing.

Press ENTER to Update Flash SIMM data
--

7. Press **Enter** again to confirm or any other button to abort. The following screen appears:

CHANGING SIMM NAME & ID (takes about 2 minutes)
--

8. The Flash presets cannot be used until XK-6 is rebooted (power off then on). **Reboot** the XK-6 and verify that the new Flash bank has been properly renamed.

Duplicate Flash

This utility allows you to duplicate Flash SIMMs using XK-6. Both Sound and Preset data is copied when a Flash SIMM is duplicated. A factory sound SIMM cannot be copied using this utility.

The SIMM sockets are marked 0, 1, 2, 3. The Flash SIMM you want to copy **MUST** be placed into SIMM Socket 0. The destination Flash SIMM must be placed in SIMM socket 1. See “Installing Sound SIMMs” on page 237.

DUPLICATE SLOT 0 FLASH
Start



If there are no Flash SIMMs in the unit, or if the SIMMs are in the wrong slots, an error message will be displayed.

1. Make sure the two Flash SIMM are located in the required SIMM sockets.
2. Press the **Save/Copy** menu button.
3. Rotate the data entry control to select the “**Duplicate Flash SIMM**” screen shown above.
4. **Move the cursor** to the bottom line and press **Enter**. The following screen appears and the Enter LED will be flashing.

Press ENTER to overwrite
the Flash SIMM in Slot 1

5. Press **Enter** again to confirm or any other button to abort. The following screen appears and the SIMM is copied.

DUPLICATING SLOT 0 -> SLOT 1
(Takes about 5 minutes)

6. When XK-6 has finished duplicating the SIMM, turn power off, remove the copied SIMM, then **reboot**. That's it!

Create Random Preset

This is a great feature which creates a new preset using portions of the ROM presets as source material. By merging random presets, really great sounding presets can be generated with ease. Use this feature to generate wild new sounds, get new programming ideas or just for fun.



*Examine interesting
presets to learn how they work
using the Edit menu.*

► To Create a Random Preset:

1. Press the **Save/Copy** menu button.
2. Move the cursor to the bottom line on the display and press **Enter**.
3. A new random preset will be created.
4. Don't like the sound? Press **Enter** again and a new random sound will be generated.



Preset Programming

There is so much you can do with the XK-6 it would be impossible to describe it all. This chapter will give you a few ideas for programming your own custom sounds and contains step-by-step instructions to help you get started. In order to get the most from this chapter, we recommend you actually try each example.

Editing Presets

One of the easiest ways to make a new preset is to edit an existing preset. This is also an excellent way of becoming familiar with XK-6. If you don't like what you hear, simply select a new preset, then XK-6 reverts to the original sound. Changes are not permanent until you Save them (see "Saving a Preset" on page 187).

Let's experiment and modify a few parameters of an existing preset. We'll start with functions that have an obvious effect on the sound: Instrument Select, Tuning, and Chorus.

Changing the Instrument

Changing the instrument is the easiest and most dramatic way to modify an existing preset.

► To Change the Instrument for the Current Layer:

1. Choose any cool preset, then press the **Preset Edit** button.
2. Press the **#1 Jump button** twice to jump directly to the Instrument page. See "Preset Menu Jump Keys" on page 36.



The **Preset Edit Jump Buttons** are located in the "Command Functions" section of the front panel.



3. Move the **cursor** down to the bottom line (using a **Cursor** button).
4. Use the **Channel** button to turn select the various layers. Use the **data entry control** to turn **OFF** all layers except **L1**. This allows you to hear the different instruments by themselves.
5. **Play the keyboard** as you scroll through the various instruments.

► **To Change the Instrument for any Layer in the Preset:**

6. Use the **Channel Select** buttons to select another layer.



7. Find another instrument that sounds good when combined with the previous instrument selected.
8. Repeat steps 6 and 7 if you want to add additional layers (although two layers will be enough for these experiments).

Now let's play with the tuning.

*Changing the Tuning
of an Instrument*

Tuning the selected layer of the preset changes the pitch of the key on the controller. If the numbers are "00," it means that the instruments are tuned to concert pitch (A=440 Hz). The Coarse tuning value represents whole semitone intervals. The Fine tuning value shifts the pitch in 1/64 semitones (or 1.56 cents).

► **To Tune the Instrument of the Current Layer:**

1. Press the #3 **Jump** button twice to jump directly to **Tuning** page.

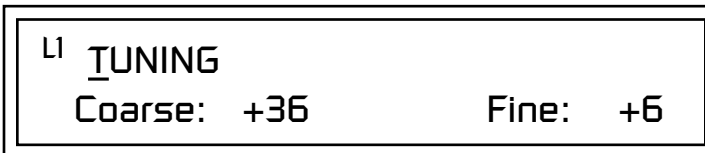

2. Move the cursor to the **Coarse** field (using the cursor button).
3. **Set the value to +12** to shift the pitch up a whole octave. To shift the pitch in smaller units than a semitone, **use the Fine field**.

Try tuning one of the instruments to a perfect fifth above the other by setting the Coarse value to +7.

Tuning an instrument far out of its normal range completely changes the character of the sound. For example, if you tune a bass guitar up 2 octaves, it's going to sound rather petite. On the other hand, if you tune it down 2 octaves, you can probably rattle plaster off the walls! Experiment with radical pitch shifting. You'll be surprised at the results.

Chorus



WARNING: Since it works by doubling the instruments, Chorus halves the number of notes you can play on XK-6.

This is an easy one. Chorus works by doubling the instruments and detuning them slightly. The larger the chorus value, the more detuning occurs. The Width parameter controls the stereo spread. A Width value of 0% reduces the chorus to mono, a value of 100% provides the most stereo separation. Chorus is useful when you want to “fatten up” a part quickly and easily.

► To Chorus a Layer:

1. Press the **#5 Jump button** to jump directly to the Chorus page.
2. Use the **cursor buttons** to advance the cursor to the Chorus field (the first field in the bottom line of the display). Use the **data entry control** to turn on chorus.

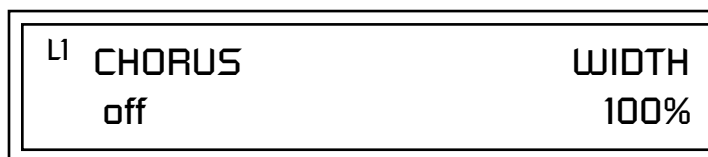

3. **Select a Width value** based on the amount of detuning you want. Smaller numbers mean less detuning, larger ones more.

You can select various amounts of chorusing for each of the instruments, just play around with the Chorus and Width parameter until you like what you hear.

Volume Envelope

Every sound you hear, whether it’s a piano note, a drum, or a bell, has a characteristic volume curve or envelope. This Volume Envelope shapes the volume of the sound which grows louder or softer in various ways during the course of the sound. The volume envelope of a sound is one of the clues our brain uses to determine what type of sound is being produced.

An envelope shapes the sound or volume of the sound over time. The envelope generators in XK-6 all have six stages to the contour: Attack 1, Attack 2, Decay 1, Decay 2, Release 1 and Release 2. When you press a key on the keyboard, the envelope goes through each of the first four stages, advancing to the next stage when the defined Level for each is reached. As long as you continue to hold the key down, the envelope continues through the first four stages holding at the end of the Decay 2 level until the key is released. When you release the key, the envelope jumps to the Release stages (no matter where the envelope is when you release the key) ending at the Release 2 level.

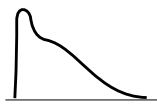

Piano

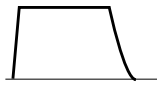

Organ



Strings

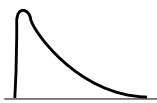

Percussion

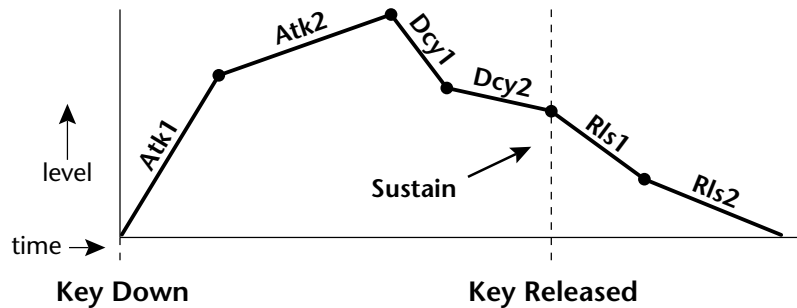

Every instrument in XK-6 has its own predetermined volume envelope which is used when the Volume Envelope parameter is set to “factory.” By setting the Volume Envelope to “time-based” or “tempo-based,” we can reshape the instrument’s natural volume envelope any way we want. By reshaping the volume envelope of an instrument, you can dramatically change the way the sound is perceived. For example, you can make “bowed” pianos or backward gongs. The diagrams to the left show the characteristic volume envelopes of a few common sounds.

In preparation for this experiment choose almost any of the standard organ presets which sustain as long as the key is held down. Go to the Instrument page and set it to “None” on all layers except Layer 1. Now you’re ready to play with the Volume Envelope.

► **Adjusting the Volume Envelope (the easy way):**

Many sounds don’t require a complex six-segment envelope. Over the years, a simpler Attack-Decay-Sustain-Release envelope, or ADSR, have become standard. The front panel controller knobs on XK-6 have been preprogrammed to adjust these four volume envelope parameters. A diagram of this standard ADSR envelope is shown below.

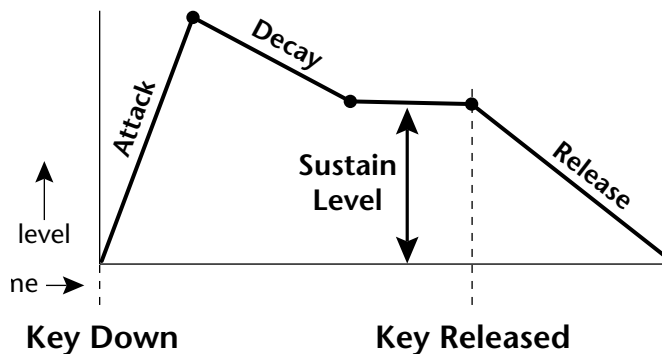

1. Front panel knobs E-H are routed to the volume envelope parameters. This is the easiest way to change the volume envelope settings.
2. Press the front panel Controller button E-H to select: Amp Attack, Amp Decay, Amp Sustain, Amp Release.

3. Increase the Amp Attack knob and play a note. The attack controls the time it takes for the sound to reach the Attack level when a key is pressed and held.
4. Increase the Amp Release knob. Note the effect as you release the key. The Release stages controls the time it takes for the sound to die away when a note is released.
5. Try out the Sustain & Release knobs. The Sustain knob control the volume LEVEL after the Decay phase has finished and while the key continues to be held. As soon as you release the key, the Release phase begins.

► **To Create a Complex Volume Envelope:**

1. Go to the **Volume Envelope** mode screen, by pressing the “Amp” jump button twice, and set the Volume Envelope mode to “time-based.”

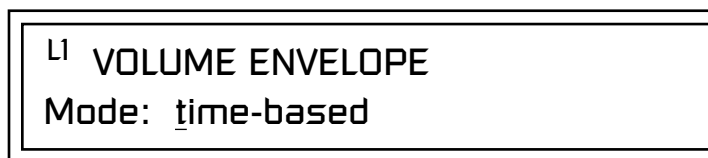

2. Now move on to the next screen to set the Volume Envelope parameters.

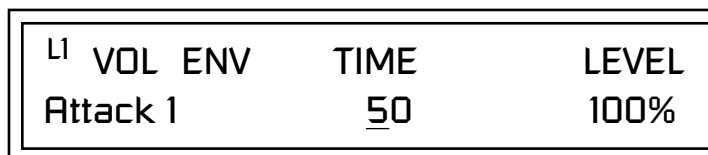

3. Increase the Attack 1 time value and play a note. The attack controls the time it takes for the sound to reach the Attack level when a key is pressed and held.
4. Move the cursor to the first field in the bottom line and use the cursor buttons to advance to the Release pages.
5. Increase the Release 1 and 2 times. Note the effect as you release the key on the controller. The Release stages controls the time it takes for the sound to die away when a note is released.

► **To Setup the Volume Envelope as an ADSR:**

The classic synthesizer ADSR (Attack-Decay-Sustain-Release) envelope is easy to create using the XK-6 six segment envelope generators. The trick is to only use segments: Attack1, Decay2, and Release1.

1. Set Atk1, Atk2 & Dcy1 levels to 100.
2. Set Rls1 & Rls2 levels to 0.

 Front panel knobs 5-8 are routed to the volume envelope parameters and thus affect the settings. You may want to disconnect the PatchCords to gain total control of the envelope parameters. (Alternately, you can create a completely blank preset and start from there.)

3. Set Atk2, Dcy1 and Rls2 rates to 0.
4. Program the Atk1, Dcy2 and Rls1 segments as you wish. Decay 2 level is your Sustain level.

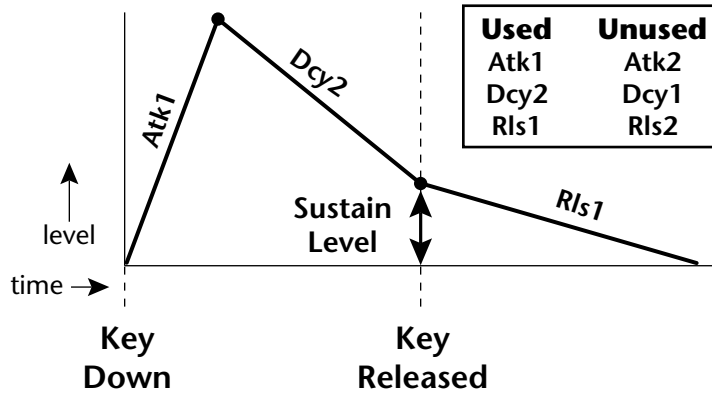

Working with Filters

The filters make it possible to remove certain components of the sound. A low pass filter removes the high frequency components or put another way, it “lets the low frequencies pass.” A high-pass filter removes the low frequency components from the sound letting only the high frequencies pass. See “XK-6 Filter Types” on page 148 for a complete list of XK-6’s filters and their descriptions.

In preparation for the next tutorial, set up the XK-6 with a single instrument layer on Layer 1.

1. Go to the Instrument screen (Preset Edit menu) and select **Instrument #124 - Interference**. This is a harmonically rich sound. Since filters work by removing or accentuating certain frequencies, we want to make sure that we have a lot of frequencies to start with.
1. Advance to the Filter Type screen using the data entry control. Select the **Classic 4th order filter**.

L1	FILTER	Ord	Type
	Classic	4	LPF

 Front panel knobs A & B are routed to the filter parameters and will affect the initial settings made here.

1. The Filter Frequency and Q (resonance) are preprogrammed to the front panel controller knobs A & B. This is the easiest way to change the volume envelope settings.
2. Press the front panel **Controller button A-D** to select controls A-D

The Frequency parameter determines the filter cutoff frequency or the frequency the filter uses as the highest frequency allowed to pass. If you play the keyboard now, you should hear the raw sound. Slowly decrease the filter cutoff frequency value as you play the keyboard. The sound

gets more and more dull as you remove more and more high frequencies from the sound. At some point, the sound completely disappears. (You have filtered out everything.) The chart on the following page illustrates what you just did.

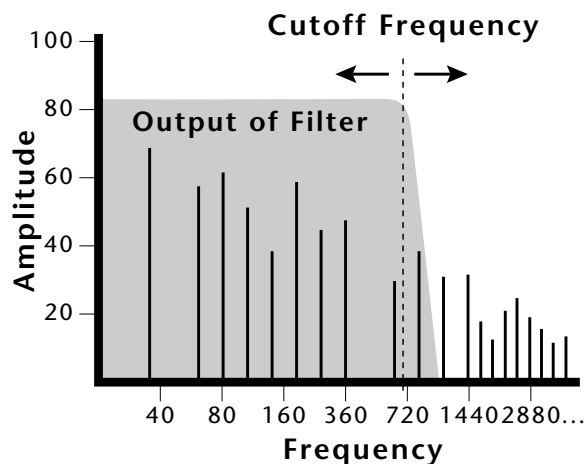

3. Turn the filter back up to full, then **adjust the Q**.
4. Set the Q about halfway up, then adjust the **Cutoff** as you play the keyboard. As you change the Cutoff, notice that the sound now has a sharp, nasal quality. A high Q boosts or amplifies the frequencies at the cutoff frequency (F_c).

Adding the Filter Envelope

Now let's modulate the Filter Frequency with the Filter Envelope. The Filter Envelope is a device that can automatically change the filter frequency during the course of the note. Before we define the Filter Envelope, we need to patch the Filter Envelope to the Filter Frequency.

► To Setup the Filter Envelope:

1. Go to the **PatchCord** screen by pressing the **Cords Jump Key**.

L1	PATCHCORD	#03
FiltEnv+	-> FiltFreq	+100

2. Move the **cursor** to **PatchCord #3**. This patchcord is preprogrammed to connect the Filter Envelope to Filter Cutoff Frequency.
3. Move the **cursor** to the last field in the lower line. This is the **Amount** field. The Amount field determines the amount of modulation applied. Set this value to **+100**.

L1	PATCHCORD	#01
<u>F</u> iltEnv+	->	FiltFreq +100

This setup connects the Filter Envelope Generator to the Filter Cutoff as shown in the following diagram.

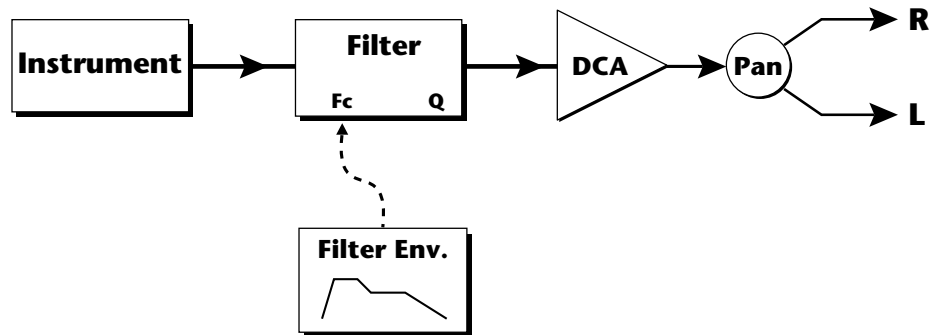

4. On the front panel knob controllers, choose controls A-D.
5. Adjust **Filter Attack** and **Filter Release** knobs and note their effect on the sound.
6. Now, return to the **Filter Envelope Mode** screen. Set the Mode to “time-based.”

L1	FILTER ENVELOPE
<u>M</u> ode:	time-based

7. Advance to the **Filter Envelope** parameter page.

L1	FILT ENV	RATE	LEVEL
<u>A</u> ttack1		50	100%

8. Move the cursor underneath the **time field** and change the value to about +50. Now when you press a key the filter slowly sweeps up.

L1 FILT ENV	RATE	LEVEL
Attack1	50	+88%

9. Change the **attack rate** and note the change in the sound.
10. Set the envelope parameters as shown in the following table.

Envelope Phase	Time	Level %
Attack 1	40	65
Attack 2	65	100
Decay 1	80	85
Decay 2	25	50
Release 1	97	20
Release 2	73	0

With the above setup, the filter sweeps up, then Decays back down to the Decay 2 Level until you release the key. Then it sweeps down at the Release rates. Play with the envelope parameters for awhile to get a feel for their function. (If you're having trouble understanding the Envelope Generators, please refer to the Programming Basics section in this manual.)

Changing Filter Types

Go back to the Filter Type screen shown below and move the cursor down the lower line of the display. Change the filter type while playing the keyboard. There are 50 different filter types.

L1 FILTER	Ord	Type
Aah-Ay-Eeh	6	VOW

These filters are extremely powerful and have been carefully crafted to offer maximum flexibility and musical control. You may want to change the Envelope (PatchCord) Amount, Q and/or the Filter Frequency to get the right sound for each filter and instrument. These three controls, coupled with the Filter Envelope, are perhaps the most important controls on any synthesizer. Take the time to learn how they interact with each other and you will be able to create sounds beyond imagination.

Envelope Repeat

The Envelope Generator can also be made to repeat. When the envelope repeat function is On, the Attack (1&2) and Decay (1&2) stages will continue to repeat as long as the key is held.

► To Make the Filter Envelope Repeat:

1. Go to the Filter Envelope **Mode** screen shown below.
2. Move the **cursor** to the Mode field.



3. Turn the **data entry control** clockwise. The Mode field will change to Repeat as shown below.



4. Move the **cursor** to the on/off field and turn **Envelope Repeat On**.
5. **Play a key** on the keyboard. You should now hear the envelope repeating.
6. Go back to the envelope parameter page and **adjust the Attack 1&2**, and Decay 1&2 parameters. The repeating envelope cycles through these four stages as long as the key is held.

Practice Modulating

- Try modulating the pitch with the Filter Envelope generator.
- Use Velocity to modulate the Filter Envelope PatchCord or the Filter Frequency. This brightens the sound as you play harder.
- Program the LFO to modulate Filter Frequency and Volume (Patch-Cord screen).
- Modulate the LFO with the other LFO, with Velocity, and with the Pitch Wheel.
- Examine the Factory presets to learn how they're constructed. There are lots of cool synthesis tricks you can use in your own presets.
- We've programmed the front panel knobs our way, but since they're completely programmable there's no reason why you can't create your own custom controls.
- Think of ten exotic modulation routings, then try them out. Experimentation is the key to learning how to control XK-6.

Troubleshooting

A common source of confusion when working with the filter envelope is that the Attack or Release parameters might not seem to be working correctly. If you are not getting the expected result, try to analyze the situation. There will be many times when you will have to stop for a minute and think, “What am I trying to do and why isn't it working?” When this happens (and it will), don't panic. Troubleshooting is a normal part of the synthesis process. Simply examine the various parameters and try to be as analytical as possible as you solve the problem. The solution is usually simple. (“The filter is already wide open and can't open any more.” or “Another PatchCord is connecting something to the parameter and affecting it.”) Learning to play any instrument takes a little patience and practice.

Referring to the diagram below which shows the XK-6 signal flow, notice that the DCA comes after the Filter. The DCA controls the final volume of the sound, so if the filter's release is longer than the release for the DCA, you won't hear it, because the DCA has already shut off the sound.

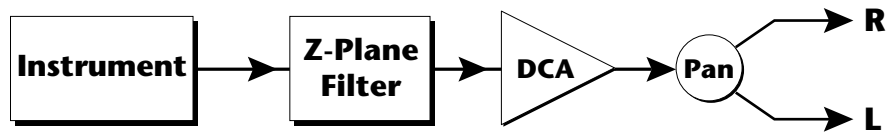

You're getting the general idea by now. Remember not to select a new preset before saving the current one or all your changes will be lost (the preset reverts to the last saved version). If you want to save your creation, select the Save/Copy menu and select a destination preset location for your masterpiece, then press Enter.

Because you can save your work, it's worth spending time to get the sound just right. When designing sounds you become an instrument builder as well as a musician. With XK-6 you can design the custom radical instruments you've always wanted!

Linking Presets

 See "Preset Links" on page 170 for more information.

Using the Link pages in the Edit menu is a quick and easy way to create new sounds. Use the Links to "layer" presets and to "split" a keyboard into sections containing different sounds.

► To Layer Two Presets:

1. Select the first preset you want to layer.
2. Press the **Preset Edit** button.
3. Go to the **Link** screen by pressing the **Links Jump Key**.

LINK 1	PRESET	XROM1
off		

4. Move the cursor to the second line of the display. Select the preset you want to link with the preset you selected in step 1. Play the keyboard as you scroll through the various presets to hear the results.
5. If you want the link to be a permanent part of the preset, be sure to save the preset. Otherwise, simply change the preset to erase your work.

► To Create a Split Keyboard Using Links:

1. Follow steps 1 through 4 above.
2. Press **Enter** and use the **Jump Key** to advance to the next page.

LINK 1	KEY	VEL
RANGE	C-2 B4	000 127

3. Set the keyboard range of the linked preset as desired.
4. Press **Enter** and use the **data entry control** to go to the Key Range page using the **Ranges** jump key.

L1	KEY:LO	FADE	HIGH	FADE
	C5	000	G8	000

5. Set the range of the original preset so it fills the remaining keyboard area. **Save the preset.**

Appendix

Front Panel Knob Functions

This section provides some of the more technical information about XK-6. In this appendix, you will find information about velocity curves, MIDI commands and PatchCord charts.

The front panel knob functions are standardized for most of the factory presets. The typical functions of the controller knobs are described below. Match the controller knobs on an external MIDI controller to the Realtime Controller Assignments in the Controllers menu if you want to externally control these functions.



Knob Controller Descriptions



The Front Panel Knobs can be reprogrammed for each preset and stored in any of the User Presets. The functions shown here are the factory programmed settings.

Filter Cutoff	Filter Frequency
Filter Q	Filter Resonance
Filter Attack	Filter Envelope Attack Rate
Filter Decay	Filter Envelope Decay and Release Rate
Amp Attack	Volume Envelope Attack Rate
Amp Decay	Volume Envelope Decay Rate
Amp Sustain	Volume Envelope Sustain Level
Amp Release	Volume Envelope Release Rate
Velocity -> Amp	Key Velocity to Volume
Velocity -> Filter	Key Velocity to Filter Frequency
LFO 2 Amount	LFO 2 Amount
LFO 2 Rate	LFO 2 Frequency
Mod 1	FX Send A (bts:preset = Beats Busy)
Mod 2	FX Send B (bts:preset = Beats Variation) (jam:preset = Beats Busy)
Arp Velocity	Scales the Velocity values of arpeggiated notes
Arp Gate	Varies the arpeggiator Gate Time

Jam Presets

Jam presets are very similar to **bts:** presets, but are designed for you to jam along playing the keyboard part. Simply select a **jam:** preset and press the Audition button. Select the **Triggers** command function and press the sixteen trigger buttons to turn the accompaniment parts on and off. Please note that not all the buttons are assigned on jam: presets.

Preset Listing

User Bank 0, XK-6 Bank 4

0. jam:Gothica	43. bas:Image Bass	85. vox:ESQ-1 Choir
1. jam:Edgey	44. bas:Edge Bass	86. vox:Maranatha II
2. jam:Xstatic	45. bas:Future Bass	87. hit:Soul Tags
3. jam:Sparkler	46. bas:Snap Case	88. hit:GrainyHit
4. jam:Metro	47. key:Pretty EP	89. hit:Orch+Clap
5. jam:Humana	48. key:FM EP	90. hit:Cold Hit
6. jam:Inspiration	49. key:Classic EP	91. hit:Darkness
7. bts:House Groove	50. key:Pop Tort	92. brs:Just Kool
8. bts:Hard Anthem	51. key:Simblox	93. gtr:Strum&Bass
9. bts:Euro Beatz	52. key:Metapad	94. pad:MassivSaw
10. bts:Mr.Logic	53. key:Neotundra	95. pad:Snowblind
11. bts:Avenger	54. key:Bass Piano	96. pad:Angry Bots
12. bts:Night Ride	55. key:Superfisa	97. pad:CrossingOver
13. bts:a la Rock	56. key:Club Organ	98. pad:BasFluff
14. bts:LeaveItAlone	57. key:Dreamland	99. pad:ChimeTrance
15. bts:UBradeRunner	58. key:Dance Klav	100. pad:TheBigLife
16. bts:HighRise	59. syn:Analog Saw	101. cmb:Gtr Heaven
17. bts:Liquid Cycle	60. syn:Chiff Square	102. cmb:Sunny
18. bts:Dodecahedron	61. syn:GlideStripes	103. cmb:Dark Castle
19. bts:Sassafras	62. syn:BossFilterz	104. sfx:Alien Call
20. bts:Space Race	63. syn:Randomizer	105. sfx:Stone Scrape
21. bts:Go BF 2002	64. syn:Doom Growler	106. sfx:The Rip
22. bts:Pulverize	65. syn:Orbotron	107. prc:Mallet Synth
23. bts:Boomstick	66. syn:The Strange	108. prc:AllScratches
24. bts:Luvinda3Way	67. syn:RingModKeyz	109. prc:Fat Kicks
25. bts:Nu Space 7	68. syn:AirBell	110. kit:PulseShiftR
26. arp:Snowfall	69. syn:Sync Waves	111. bts:ShoppinSpree
27. arp:BlasterMan50	70. syn:Big Synth	112. bts:Broken Kit
28. arp:Terradactyl	71. syn:BigJuKnow	113. bts:Out Cold
29. arp:MinorCell	72. syn:Mach Sync	114. bts:ToThe J R
30. arp:NoWare	73. syn:Analog PWM	115. bts:Smoking Room
31. arp:8Oh 8 Play	74. syn:Super CZ	116. bts:Planet E-MU
32. arp:RaguMoPlay	75. syn:Stop Gap	117. bts:NubChompa!
33. arp:SqrKit Jam	76. syn:SpaceGong	118. bts:2X1/2TimeD&B
34. arp:Thumper	77. led:QuiverWorm	119. bts:DephBreaker
35. arp:Tribal Kit	78. led:WetCZ	120. bts:DeepDownload
36. arp:Gritar	79. led:Squared	121. bts:Underwhirled
37. arp:Funk Sauce	80. led:Lo-Fi Square	122. bts:Feelin House
38. arp:TekOrgan	81. bel:SupraChime	123. bts:PimpinItHard
39. arp:HugePaddy	82. vox:ClassicQuire	124. bts:Euro House
40. arp:Oink	83. vox:Ancients	125. bts:Stadium Btz
41. bpm:Quavering	84. vox:FuzzChoir	126. bts:Garage Style
42. bas:Black Hole		127. bts:Magic Air

Preset Listing

User Bank 1, XK-6 Bank 0

- | | | |
|---------------------|----------------------|-----------------------|
| 0. kit:K-0 | 43. kit:K-13 QP-Dly | 86. hit:Nice 1 |
| 1. kit:K-1 | 44. kit:K-14 D-Down | 87. hit:Nice 2 |
| 2. kit:K-2 | 45. kit:K-15 D-D2 | 88. hit:Nice 3 |
| 3. kit:K-3 | 46. kit:K-16 Tremor | 89. hit:Logger |
| 4. kit:K-4 | 47. kit:808 Delay | 90. hit:Dance 1 |
| 5. kit:K-5 | 48. kit:Envelope | 91. hit:Dance 2 |
| 6. kit:K-6 | 49. prc:Kicks 1 | 92. hit:Dance 3 |
| 7. kit:K-7 | 50. prc:Kicks 2 | 93. hit:Dance 4 |
| 8. kit:K-8 | 51. prc:Solo Kick 1 | 94. hit:Dance 8 |
| 9. kit:K-9 | 52. prc:Solo Kick 2 | 95. hit:Dance 11 |
| 10. kit:K-10 | 53. prc:Snare 1 | 96. hit:Dance 12 |
| 11. kit:K-11 | 54. prc:Snare 2 | 97. hit:Dance 14 |
| 12. kit:K-12 | 55. prc:Snare 1 +7 | 98. hit:Dance 16 |
| 13. kit:K-13 | 56. prc:Snare 2 Eff | 99. hit:Dance 20 |
| 14. kit:K-14 | 57. prc:Snare 2 Rev | 100. hit:Dance 21 |
| 15. kit:K-15 | 58. prc:Snare Fill 1 | 101. hit:Dance 22 |
| 16. kit:K-16 | 59. prc:Snare Fill 2 | 102. hit:Dance 23 |
| 17. kit:K-17 | 60. prc:Ambi Snare | 103. hit:Dance 24 |
| 18. kit:K-808 | 61. prc:Toms & Stuff | 104. hit:Dance 25 |
| 19. kit:K-909 | 62. prc:Congas etc 1 | 105. hit:Dance 26 |
| 20. kit:Acoustic 1 | 63. prc:Congas etc 2 | 106. hit:Organ 3 |
| 21. kit:Acoustic 2 | 64. prc:Hats 1 | 107. hit:Organ 4 |
| 22. kit:Hybrid | 65. prc:Hats 2 | 108. hit:Organ 5 |
| 23. kit:Hard 1 | 66. prc:Solo Hat 1 | 109. hit:Organ 6 |
| 24. kit:Hard 2 | 67. prc:Solo Hat 2 | 110. hit:UnisonString |
| 25. kit:K-1 HPF | 68. prc:Tambs | 111. hit:Unison Brass |
| 26. kit:K-1 up 9 | 69. prc:Cymbals | 112. hit:Brass 6 |
| 27. kit:K-2 millini | 70. prc:Shakers etc. | 113. hit:Brass 7 |
| 28. kit:K-3 LFO~LPF | 71. prc:Bells | 114. hit:Brass 9 |
| 29. kit:K-4 LFO~AMP | 72. prc:Blocks | 115. hit:Brass 18 |
| 30. kit:K-5 Octave | 73. prc:Claps/Snaps | 116. hit:Trumpet FX 1 |
| 31. kit:K-5 up 7 | 74. prc:Misc | 117. hit:Trumpet FX 2 |
| 32. kit:K-5 Klub | 75. prc:Warehouse | 118. hit:Sax FX |
| 33. kit:K-6 Chorus | 76. prc:Scratches 1 | 119. hit:Blipp |
| 34. kit:K-7 LFO~REZ | 77. prc:Scratches 2 | 120. hit:Buzz Blip |
| 35. kit:K-8 16tsPan | 78. prc:Tic a Tak | 121. hit:Game |
| 36. kit:K-8~8 go | 79. prc:Ubu Delay FX | 122. hit:Bell |
| 37. kit:K-9 D-Pan | 80. hit:Enrezzle | 123. hit:CMI |
| 38. kit:K-9 up 12 | 81. hit:PLATINUM | 124. hit:Bass Stab |
| 39. kit:K-10 D-Up | 82. hit:Voxy | 125. hit:H G |
| 40. kit:K-10 High Q | 83. hit:Krunchy | 126. hit:H G Dive |
| 41. kit:K-11 T-Dly | 84. hit:Dreamer Tags | 127. hit:Drum Stab |
| 42. kit:K-12 Q-Dly | 85. hit:Boink-King | |

Preset Listing

User Bank 2, XK-6 Bank 1

- | | | |
|----------------------|----------------------|-----------------------|
| 0. syn:Basic Saw | 43. syn:Electric | 86. led:PureSaw |
| 1. syn:ORiON | 44. syn:CZ BIG | 87. led:Wormsine |
| 2. syn:Spiders | 45. syn:SinEnsemble | 88. led:Technoval |
| 3. syn:Nordica | 46. syn:BigDandyBoy | 89. led:Falling |
| 4. syn:Sync4Sequenc | 47. syn:Willy 4 | 90. led:Scizy 2 |
| 5. syn:Tink Or Toy | 48. syn:R&B Stegas | 91. pad:Rumble Pad |
| 6. syn:Kyng Doam | 49. syn:60-30 | 92. pad:Super Pad |
| 7. syn:70-64 | 50. syn:SweetDream | 93. pad:ARK Covet |
| 8. syn:12-30 | 51. led:Wet | 94. pad:E P I C |
| 9. syn:Trancer | 52. led:Cyber 1 | 95. pad:Sleepy |
| 10. syn:MortalSynth | 53. led:Cyber 5 | 96. pad:Tecnorise |
| 11. syn:The Grid | 54. led:Cyber 6 | 97. pad:Cvox |
| 12. syn:Calmer | 55. led:Cyber 7 | 98. pad:Soft Trace |
| 13. syn:Cyborg | 56. led:Saturn | 99. pad:Ice Dreams |
| 14. syn:South Euro 1 | 57. led:More Senses | 100. pad:Big Chief |
| 15. syn:South Euro 2 | 58. led:Wormy 2 | 101. pad:Slow Dance |
| 16. syn:Big E | 59. led:Wormy 3 | 102. pad:Warm&Lush |
| 17. syn:Riverdancing | 60. led:Zeaxy 2 | 103. pad:Art Deko |
| 18. syn:Air Age | 61. led:Brixx 2 | 104. pad:Daddy's Girl |
| 19. syn:Trem String | 62. led:Apoly 1 | 105. pad:Strings Box |
| 20. syn:OBX | 63. led:Fat S12 | 106. pad:Hi&LowLight |
| 21. syn:40-10 | 64. led:Fat CL1 | 107. pad:Vespers |
| 22. syn:12-20 | 65. led:Fat INT | 108. pad:Ambi Pad |
| 23. syn:3 O 3 | 66. led:Groove Wow | 109. pad:Pure Synth |
| 24. syn:Geaxoils | 67. led:Alter 4 | 110. pad:HarmonicLift |
| 25. syn:XtoZ | 68. led:Alter 6 | 111. pad:Lunar Trail |
| 26. syn:Munster | 69. led:Synrg 7 | 112. pad:Cryo Stasus |
| 27. syn:Booty Qooty | 70. led:Synrg 9 | 113. pad:Genesis |
| 28. syn:Uborator | 71. led:Fat Saw | 114. pad:Dark City |
| 29. syn:Prophecy | 72. led:Scizy 2 | 115. pad:SlogritStrng |
| 30. syn:Raved Pass | 73. led:Scizy 4 | 116. pad:SaturnRings |
| 31. syn:D Pee | 74. led:Jungle X | 117. pad:Smooovie |
| 32. syn:Jesuasynth | 75. led:Hypass Ditty | 118. pad:Aki's World |
| 33. syn:Wavetable | 76. led:Heavy | 119. pad:Low Back |
| 34. syn:Minor Evil | 77. led:Dreamlead | 120. pad:www.f mono |
| 35. syn:Profit Brass | 78. led:Duzbe 2 | 121. pad:Spelunkers |
| 36. syn:Sweepy | 79. led:Fuzzer | 122. pad:Lifedream |
| 37. syn:Glider | 80. led:Weezel | 123. pad:Perception |
| 38. syn:Grumpy | 81. led:Noise F | 124. pad:Involved |
| 39. syn:Gothica | 82. led:P Mod 1 | 125. pad:Lo Fi String |
| 40. syn:Too Big | 83. led:DesertTrance | 126. pad:AmbString 1 |
| 41. syn:Echoing | 84. led:TB 2 | 127. pad:AmbString 2 |
| 42. syn:Screamer | 85. led:Metallic | |

Preset Listing

User Bank 3, XK-6 Bank 2

- | | | |
|----------------------|----------------------|-----------------------|
| 0. bas:Top Tri | 43. edg:Boxt | 86. wal:Luscious |
| 1. bas:UK shoota | 44. edg:Matrix | 87. nse:Interfear |
| 2. bas:Love Bee | 45. edg:Honker | 88. nse:Diffuser |
| 3. bas:Jump Up | 46. edg:Analog Beast | 89. nse:Radon Shield |
| 4. bas:Sub Duh | 47. edg:Zorkon | 90. nse:That'sCreepy |
| 5. bas:Hybrid Phase | 48. edg:AudKlav | 91. nse:Future Steps |
| 6. bas:A.D. 3033 | 49. edg:Scrape | 92. nse:LittleWeasel |
| 7. bas:Vortex | 50. edg:Hlywd Native | 93. nse:Martians |
| 8. bas:Saws Normal | 51. edg:Ringer | 94. nse:Cast |
| 9. bas:1 Shot | 52. edg:Bare Edge | 95. nse:SpottedWhite |
| 10. bas:Hard X | 53. edg:Spawn | 96. nse:Heavy Mental |
| 11. bas:Pinhead | 54. edg:Rez Zip | 97. nse:Hadrian's |
| 12. bas:Go Long | 55. edg:FuzzGrinder | 98. nse:Machined |
| 13. bas:Square V | 56. edg:Love All | 99. nse:Rezawrect |
| 14. bas:H20 | 57. edg:Squeake | 100. nse:Massive |
| 15. bas:Interference | 58. edg:2 Flange | 101. nse:Soline 7x |
| 16. bas:B-Acer | 59. edg:Teeth | 102. nse:Quiet Wall |
| 17. bas:P-dg | 60. edg:Slicer | 103. nse:Bottom Floor |
| 18. bas:Fatso | 61. edg:Skreecher | 104. nse:Distructor |
| 19. bas:F16 | 62. edg:Love Hurts | 105. nse:Undertaker |
| 20. bas:Acid 7 | 63. wal:Strangled | 106. nse:Coyote |
| 21. bas:Sonic | 64. wal:The Macheen | 107. nse:Turbonic |
| 22. bas:Bullit | 65. wal:Duckfuzz | 108. nse:GrainyPixel |
| 23. bas:Dance II | 66. wal:C-Ride | 109. nse:Faucet Drip |
| 24. bas:Rippedbass | 67. wal:HoverCraft | 110. nse:Psychic Sea |
| 25. bas:Depth | 68. wal:Clavonate | 111. nse:Aarno Ldt |
| 26. bas:Arplikebass | 69. wal:DailyBread | 112. key:Smarm Organ |
| 27. bas:Fat Arc | 70. wal:I made it | 113. key:Disca Queen |
| 28. bas:PPX 1 | 71. wal:Backdraft | 114. key:Rave Organ |
| 29. bas:PPX 2 | 72. wal:Mammoth | 115. key:Organik |
| 30. bas:Jungle Sub | 73. wal:Maryland | 116. key:SynhissOrgan |
| 31. bas:Fat Juno | 74. wal:Thickets | 117. key:Deep Organ |
| 32. bas:Smooth | 75. wal:Ice Ring | 118. key:P-soul |
| 33. bas:Heavy B | 76. wal:Silkness | 119. key:TechnoGrand |
| 34. bas:Sub E | 77. wal:Byzantine | 120. key:Ocean |
| 35. bas:S-Bass | 78. wal:Raverotic | 121. key:HybridTine |
| 36. bas:Thwip | 79. wal:Ripped | 122. key:EP Roll 1 |
| 37. bas:Log Bass | 80. wal:Balls2The.. | 123. key:EP Roll 2 |
| 38. bas:Disser | 81. wal:W6 3sEvEn | 124. key:EP Fog |
| 39. bas:Sunny | 82. wal:Abyss | 125. gtr:Guit Hits |
| 40. bas:HardHouse | 83. wal:GoSpeedRacer | 126. gtr:Univibe |
| 41. bas:Garage Sub | 84. wal:Tension | 127. gtr:Clicky Picky |
| 42. bas:Planet X | 85. wal:Big Wall | |

Preset Listing

XK-6 Bank 3

- | | | |
|----------------------|----------------------|------------------------|
| 0. arp:Deeper Love | 43. bpm:Underclass | 86. vox:Lushorch Vox |
| 1. arp:Glider | 44. bpm:Tempo LFOs | 87. vox:Toxic Vox |
| 2. arp:Alloy M | 45. bpm:Carpe Diem | 88. vox:Zephyr |
| 3. arp:JUNOsis | 46. bpm:L Room | 89. vox:Air Voices |
| 4. arp:A Trip | 47. bpm:Reepeter | 90. vox:SIRRUS |
| 5. arp:Dreamer | 48. bpm:Solace | 91. vox:Future Vox |
| 6. arp:Palomar | 49. bpm:GRITS | 92. vox:Bliss |
| 7. arp:Raving | 50. bpm:TRIPPER | 93. vox:ARMAGEDDON |
| 8. arp:Robo Trace | 51. bpm:Higher Power | 94. vox:ANGELIKA |
| 9. arp:Glory II | 52. bpm:Trashy | 95. vox:Galaxal |
| 10. arp:Holographic | 53. bpm:Vision | 96. vox:Bandvoxxe |
| 11. arp:Pele | 54. bpm:Wading | 97. vox:Exploration |
| 12. arp:Lust II | 55. bpm:Grinded | 98. vox:AfterShock |
| 13. arp:Bottom Perc | 56. bpm:Electon | 99. vox:Surfacing |
| 14. arp:You Know It | 57. bpm:Bubbler | 100. vox:Ethereal |
| 15. arp:X-light II | 58. bpm:End | 101. vox:Suffocating |
| 16. arp:OrbisTabula | 59. bpm:Wicked Low | 102. vox:Space Voxxal |
| 17. arp:OrbisPitcher | 60. bpm:RadioDaze | 103. sfx:Moby's Trip |
| 18. arp:The Grind | 61. bpm:Panhandel | 104. sfx:Odd Quasar |
| 19. arp:Tron X | 62. bpm:Minator | 105. sfx:S-METAL |
| 20. arp:Dry Wastland | 63. bpm:Lucy-Q | 106. sfx:Zoned |
| 21. arp:Axis One | 64. air:Bat Pann | 107. sfx:OverTheEdge |
| 22. arp:Bouchete | 65. air:GhostStories | 108. sfx:Granules |
| 23. arp:Saw Standard | 66. air:Breath Stack | 109. sfx:Glassers |
| 24. arp:Phrophetics | 67. air:Tibet | 110. sfx:Alienator |
| 25. arp:Sine Drum | 68. air:Futura | 111. sfx:Ripped Lazer |
| 26. arp:Gutter Punk | 69. air:Air Surf | 112. sfx:FoldingSpace |
| 27. arp:MooGie-D | 70. air:Eastern Mist | 113. sfx:Uncertainty |
| 28. arp:No Lo | 71. air:Vampirella | 114. sfx:Cosmic-Compny |
| 29. arp:Sanctuary | 72. air:Floater | 115. sfx:REZA'S LaB |
| 30. arp:Pissto Hi | 73. air:Warm Chill | 116. sfx:TerrorZoNE |
| 31. arp:T-2000 | 74. air:Digital Noiz | 117. sfx:LupeDeKool |
| 32. bpm:Bouncerette | 75. air:Scary Noise | 118. sfx:CyberSience |
| 33. bpm:Traveler | 76. air:StickyFinger | 119. bel:Modular Ring |
| 34. bpm:Boogy Synth | 77. air:LeaveMeAlone | 120. bel:Efemm Bellsa |
| 35. bpm:Lighter | 78. air:Breathless | 121. bel:Mult-A-Metal |
| 36. bpm:End | 79. air:FluteState | 122. bel:Mystery Bell |
| 37. bpm:E Room | 80. vox:LuciferDom | 123. bel:NordicCalm |
| 38. bpm:Monster | 81. vox:Upper Bottom | 124. bel:Rainbellz |
| 39. bpm:Peak 7 | 82. vox:QVoxDelay | 125. bel:Agualla Bell |
| 40. bpm:Cult-feel | 83. vox:Aah Eeh | 126. bel:Capsulate |
| 41. bpm:Love II | 84. vox:Choirish | 127. :XL-7 default |
| 42. bpm:Synthex 90' | 85. vox:Ooh,Voices! | |

Instrument Listing

This section lists the raw instruments in the XK-6 “XROM1” set. Instruments consist of either multisamples or single samples.

- | | | |
|--------------------|---------------------|---------------------|
| 0. None | 41. Audity Synth 2 | 82. Zeek Bass |
| 1. Sine Wave | 42. Audity Synth 3 | 83. Audity Bell 1 |
| 2. Saw Wave | 43. Audity Synth 4 | 84. Audity Bell 2 |
| 3. Square Wave | 44. Audity Synth 5 | 85. Audity Bell 3 |
| 4. Triangle Wave | 45. Audity Synth 6 | 86. Audity Bell 4 |
| 5. Audity Saw | 46. Audity Synth 7 | 87. Audity Bell 5 |
| 6. Audity Square | 47. Audity Synth 8 | 88. Vox Humana |
| 7. Audity Blend | 48. Audity Synth 9 | 89. Vapor Vox |
| 8. Audity Sync | 49. Audity Synth 10 | 90. Chronic Vox |
| 9. Audity Sync | 50. Audity Synth 11 | 91. Vox Wave 1 |
| 10. Audity Sync 1 | 51. Audity Synth 12 | 92. Vox Wave 2 |
| 11. Audity Sync 2 | 52. Audity Synth 13 | 93. Vox Wave 3 |
| 12. Audity Sync 3 | 53. Audity Synth 14 | 94. Vox Wave 4 |
| 13. Audity PWM 1 | 54. Audity Bass 1 | 95. Vox Wave 5 |
| 14. Audity PWM 2 | 55. Audity Bass 2 | 96. Vox Wave 6 |
| 15. Audity PWM 3 | 56. Audity Bass 3 | 97. White Noise |
| 16. Ring Mod 1 | 57. Acid Bass 1 | 98. Pink Noise |
| 17. Ring Mod 2 | 58. Acid Bass 2 | 99. Audity Wall 1 |
| 18. Ring Mod 3 | 59. Acid Bass 3 | 100. Audity Wall 2 |
| 19. Metal Wave | 60. Acid Bass 4 | 101. Audity Wall 3 |
| 20. Jungle Lead | 61. Acid Bass 5 | 102. Audity Wall 4 |
| 21. Metalik | 62. Acid Bass 6 | 103. Audity Wall 5 |
| 22. Brass Lead 1 | 63. Acid Bass 7 | 104. Audity Wall 6 |
| 23. Brass Lead 2 | 64. Acid Bass 8 | 105. Audity Wall 7 |
| 24. Audity Lead 1 | 65. Acid Bass 9 | 106. Noise Tunnel |
| 25. Audity Lead 2 | 66. Acid Bass 10 | 107. Air Pipe |
| 26. Audity Lead 3 | 67. Hybrid Bass 1 | 108. Crystal Cavern |
| 27. Audity Lead 4 | 68. Hybrid Bass 2 | 109. Sonar |
| 28. Audity Lead 5 | 69. Hybrid Bass 2b | 110. Audity Edge 1 |
| 29. Audity Lead 6 | 70. Dance Bass 1 | 111. Audity Edge 1b |
| 30. Audity Lead 7 | 71. Dance Bass 2 | 112. Audity Edge 1c |
| 31. Audity Lead 8 | 72. Mikro Bass | 113. Audity Edge 2 |
| 32. Audity Lead 9 | 73. Shush Bass | 114. Audity Edge 3 |
| 33. Audity Lead 10 | 74. Fuzz Bass | 115. Future World |
| 34. Audity Lead 11 | 75. Flange Bass | 116. Grinder |
| 35. Classic Lead 1 | 76. Buzz Bass | 117. Growly |
| 36. Classic Lead 2 | 77. Booty Q Bass 1 | 118. Cricket |
| 37. Classic Lead 3 | 78. Booty Q Bass 2 | 119. Fuzz Ball |
| 38. Classic Lead 4 | 79. Zodiac Bass 1 | 120. Droid Scrape |
| 39. Digi Lead | 80. Zodiac Bass 2 | 121. Rez Honk |
| 40. Audity Synth 1 | 81. Prodigal Bass | 122. Krunchy Hit |

Instrument Listing

123. Turbo	168. Looped Perc 29	213. 1 Shot Perc 22
124. Interference	169. Looped Perc 30	214. 1 Shot Perc 23
125. 1 Shot Bass	170. Looped Perc 31	215. 1 Shot Perc 24
126. 1 Shot Dis Bass 1	171. Looped Perc 32	216. 1 Shot Perc 25
127. 1 Shot Dis Bass 2	172. Looped Perc 33	217. 1 Shot Perc 26
128. 1 Shot Dis Bass 3	173. Looped Perc 34	218. 1 Shot Perc 27
129. 1 Shot Perc Bass	174. Looped Perc 35	219. 1 Shot Perc 28
130. 1 Shot Grind	175. Looped Perc 36	220. 1 Shot Perc 29
131. 1 Shot Siren	176. Looped Perc 37	221. 1 Shot Perc 30
132. 1 Shot Turbine	177. Looped Perc 38	222. 1 Shot Perc 31
133. 1 Shot Alien	178. Looped Perc 39	223. 1 Shot Perc 32
134. 1 Shot Laser Rip	179. Looped Perc 40	224. 1 Shot Perc 33
135. 1 Shot Aud Vox	180. Looped Perc 41	225. 1 Shot Perc 34
136. 1 Shot Scratch 1	181. Looped Perc 42	226. 1 Shot Perc 35
137. 1 Shot Scratch 2	182. Looped Perc 43	227. 1 Shot Perc 36
138. 1 Shot Scratch 3	183. Looped Perc 44	228. 1 Shot Perc 37
139. 1 Shot Scratch 4	184. Looped Perc 45	229. 1 Shot Perc 38
140. Looped Perc 1	185. Looped Perc 46	230. 1 Shot Perc 39
141. Looped Perc 2	186. Looped Perc 47	231. 1 Shot Perc 40
142. Looped Perc 3	187. Looped Perc 48	232. 1 Shot Perc 41
143. Looped Perc 4	188. Looped Perc 49	233. 1 Shot Perc 42
144. Looped Perc 5	189. Looped Perc 50	234. 1 Shot Perc 43
145. Looped Perc 6	190. Looped Perc 51	235. 1 Shot Perc 44
146. Looped Perc 7	191. Looped Perc 52	236. 1 Shot Perc 45
147. Looped Perc 8	192. 1 Shot Perc 1	237. 1 Shot Perc 46
148. Looped Perc 9	193. 1 Shot Perc 2	238. 1 Shot Perc 47
149. Looped Perc 10	194. 1 Shot Perc 3	239. 1 Shot Perc 48
150. Looped Perc 11	195. 1 Shot Perc 4	240. 1 Shot Perc 49
151. Looped Perc 12	196. 1 Shot Perc 5	241. 1 Shot Perc 50
152. Looped Perc 13	197. 1 Shot Perc 6	242. 1 Shot Perc 51
153. Looped Perc 14	198. 1 Shot Perc 7	243. 1 Shot Perc 52
154. Looped Perc 15	199. 1 Shot Perc 8	244. 1 Shot Perc 53
155. Looped Perc 16	200. 1 Shot Perc 9	245. 1 Shot Perc 54
156. Looped Perc 17	201. 1 Shot Perc 10	246. 1 Shot Perc 55
157. Looped Perc 18	202. 1 Shot Perc 11	247. 1 Shot Perc 56
158. Looped Perc 19	203. 1 Shot Perc 12	248. 1 Shot Perc 57
159. Looped Perc 20	204. 1 Shot Perc 13	249. 1 Shot Perc 58
160. Looped Perc 21	205. 1 Shot Perc 14	250. 1 Shot Perc 59
161. Looped Perc 22	206. 1 Shot Perc 15	251. 1 Shot Perc 60
162. Looped Perc 23	207. 1 Shot Perc 16	252. 1 Shot Perc 61
163. Looped Perc 24	208. 1 Shot Perc 17	253. 1 Shot Perc 62
164. Looped Perc 25	209. 1 Shot Perc 18	254. 1 Shot Perc 63
165. Looped Perc 26	210. 1 Shot Perc 19	255. 1 Shot Perc 64
166. Looped Perc 27	211. 1 Shot Perc 20	256. 1 Shot Perc 65
167. Looped Perc 28	212. 1 Shot Perc 21	257. 1 Shot Perc 66

Instrument Listing

258.	1 Shot Perc 67	303.	Analow	348.	Perco
259.	1 Shot Perc 68	304.	Moog Tri	349.	Not So Mini
260.	1 Shot Perc 69	305.	Moog Sub	350.	Spitt
261.	1 Shot Perc 70	306.	Moogy	351.	Tap
262.	1 Shot Perc 71	307.	Fat Sun	352.	Juno Sub
263.	1 Shot Perc 72	308.	Analog	353.	Complex Sub
264.	1 Shot Perc 73	309.	Q 1	354.	Full Octave
265.	1 Shot Perc 74	310.	Q 2	355.	Deep Pocket
266.	1 Shot Perc 75	311.	Q 3	356.	JP4
267.	1 Shot Perc 76	312.	Planet	357.	Synth Hits
268.	1 Shot Perc 77	313.	2600	358.	DX 1
269.	1 Shot Perc 78	314.	Synth 1	359.	DX 2
270.	1 Shot Perc 79	315.	Synth 2	360.	DX 3
271.	1 Shot Perc 80	316.	Synth 3	361.	EP 1
272.	1 Shot Perc 81	317.	Synth 4	362.	EP 2
273.	Audity Scratches	318.	Synth 5	363.	EP 3
274.	El Perc Kit 1	319.	Synth 6	364.	Home 1
275.	El Kit 1 Looped	320.	Synth 7	365.	Home 2
276.	Kit 1 Env Loops	321.	Synth 8	366.	Street
277.	El Perc Kit 2	322.	Synth 9	367.	Pure
278.	El Kit 2 Looped	323.	Synth 10	368.	Fing&Harms 1
279.	Kit 2 Env Loops	324.	TB 1	369.	Fing&Harms 2
280.	Hybrid Perc	325.	TB 2	370.	All Purpose
281.	Warehouse Perc	326.	TB 3	371.	Standard
282.	Acoustic Perc A	327.	TB 4	372.	Fretless 1
283.	Ac Kick+Snare B	328.	CZ101	373.	Fretless 2
284.	Acoustic Kit A+B	329.	PPG	374.	Fretless 3
285.	Hardcore Kit 1	330.	Mini 1	375.	Fretless 4
286.	Hardcore Kit 2	331.	Mini 2	376.	Upright 1
287.	Hardcore Kit 3	332.	Mini 3	377.	Upright 2
288.	Hum	333.	Mini 4	378.	Slap 1
289.	Below Sub	334.	Saw	379.	Slap 2
290.	Super Sub	335.	Ultimate 1	380.	Gruzy Pop
291.	SE Sub 1	336.	Ultimate 2	381.	Pop Slide 1
292.	SE Sub 2	337.	Micro Moog	382.	Pop Slide 2
293.	SE Sub 3	338.	DB9 1	383.	Pop Slide 3
294.	SE Sub 4	339.	DB9 2	384.	Pop Slide 4
295.	SE Sub 5	340.	Phlappy	385.	Funk Hits
296.	SE Sub 6	341.	Power Q	386.	Organ 1
297.	SE Sub 7	342.	Big Sync	387.	Organ 2
298.	Hit	343.	Buzzer	388.	Mutes
299.	Subtle	344.	Saw Sync	389.	Power 1
300.	Mem Moog	345.	Pocket	390.	Power 2
301.	Lowness	346.	Q Attack Sub	391.	Power Hit
302.	Ice	347.	Sonics	392.	Synth Axe

Instrument Listing

393. Hits	438. Rast Keys	483. Rezy
394. Pipe Organ	439. ARP Sync	484. Hi Octaves
395. DrawbarOrgan	440. Narrow Synth	485. Dreemy
396. Perc Organ	441. Fat Attack	486. Phat
397. Org Day	442. ARP Lead	487. Tekno
398. Disco Organ	443. Synthetic	488. Life
399. DX Organ	444. Overtone	489. Classic
400. JX Organ	445. Buzz Saw	490. Dreamer
401. Tone Organ	446. Blipper	491. Paddy
402. Simple Organ	447. Full Synth	492. Dance Chord
403. Org Lite	448. Bass Synth	493. Zoom
404. Org Nod	449. Mini Lead	494. Keyngdom
405. Full Organ	450. Sawtooth	495. Oddd Organ
406. Synth Organ	451. M12 Lead	496. Mood Strings
407. BreathyOrgan	452. Sync Wave 1	497. Brazz
408. Dance Organ	453. Sync Wave 2	498. Synthy
409. Farfisa 1	454. Sync Wave 3	499. P5
410. Farfisa 2	455. Sync Wave 4	500. Bari Wave
411. Vox Organ	456. Sync Wave 5	501. Sax Wave
412. Synth Cheeze	457. Sync Wave 6	502. Mute Trumpet
413. Organ Hits 1	458. Pop Square	503. Trumpet FX 1
414. Organ Hits 2	459. Juno Square	504. Trumpet FX 2
415. Tine EP	460. SquareAttack	505. Cool Loops
416. Pretty EP	461. Square Lead	506. Sax Riff
417. Classic EP	462. SquareChorus	507. Boink
418. FM EP 1	463. Sinusoid	508. Classic Hit
419. FM EP 2	464. Worm Lead 1	509. Hits 1
420. EP Hits	465. Worm Lead 2	510. Hits 2
421. Clavinet	466. Worm Lead 3	511. Jax Breath
422. Piano Wave	467. Worm Lead 4	512. Synth
423. Xylo Pad	468. Worm Lead 5	513. Orch
424. Pure H2O	469. Worm Lead 6	514. Soul Oohs
425. Log Hit	470. Harmonica	515. CMI Breath
426. Pluck Tone	471. Synth Flute	516. Breathy
427. Hollow Deep	472. Soft Synth	517. Tarzana
428. Bell Synth	473. Hi String	518. Gothic
429. Syn Tone	474. OBX Saws	519. Oow
430. Perc Axe	475. Big Planet	520. Vox 1
431. Whine	476. JP6 Pad	521. Vox 2
432. CZ101 Digi	477. Saw Sweep	522. Strings
433. CZ Lead	478. Juno Pulse	523. All Dance 1
434. CZ Echo Lead	479. CZ Synstring	524. All Dance 2
435. Wild Synth	480. Ensemble	525. Sound Track
436. Spacey Keys	481. Rezy Wave	526. Music Crowd
437. Digi Buzz	482. Heavy	527. Lawn Mower

Instrument Listing

528. Riff Trip	572. Cowbell	616. Dance 24
529. Cyber Pan	573. Agogos	617. Dance 25
530. Groove Thing	574. Misc 1	618. Dance 26
531. Science	575. Misc 2	619. Dance 27
532. Under Pad FM	576. kit:1	620. Organ 1
533. Sci Fi	577. kit:2	621. Organ 2
534. Synth Siren	578. kit:3	622. Organ 3
535. Metal	579. kit:4	623. Organ 4
536. Vinyl 1	580. kit:5	624. Organ 5
537. Vinyl 2	581. kit:6	625. Organ 6
538. Vinyl 3	582. kit:7	626. UnisonString
539. Vinyl 4	583. kit:8	627. Unison Brass
540. Pink	584. kit:9	628. Brass 1
541. White	585. kit:10	629. Brass 2
542. Scratches 1	586. kit:11	630. Brass 3
543. Scratches 2	587. kit:12	631. Brass 4
544. Kicks 1	588. kit:13	632. Brass 5
545. Kicks 2	589. kit:14	633. Brass 6
546. Snares 1	590. kit:15	634. Brass 7
547. Snares 2	591. kit:16	635. Brass 8
548. Toms 1	592. GM Dance	636. Brass 9
549. Toms 2	593. Dance 1	637. Brass 10
550. Timbales 1	594. Dance 2	638. Brass 11
551. Timbales 2	595. Dance 3	639. Brass 12
552. Congas etc 1	596. Dance 4	640. Brass 13
553. Congas etc 2	597. Dance 5	641. Brass 14
554. Hats 1	598. Dance 6	642. Brass 15
555. Hats 2	599. Dance 7	643. Brass 16
556. Cymbals 1	600. Dance 8	644. Brass 17
557. Cymbals 2	601. Dance 9	645. Brass 18
558. Shakers	602. Dance 10	646. Brass 19
559. Maracas	603. Dance 11	647. Brass 20
560. Bells 1	604. Dance 12	648. Trumpet FX 1
561. Bells 2	605. Dance 13	649. Trumpet FX 2
562. Blocks 1	606. Dance 14	650. Trumpet FX 3
563. Blocks 2	607. Dance 15	651. Trumpet FX 4
564. Tams 1	608. Dance 16	652. Trumpet FX 5
565. Tams 2	609. Dance 17	653. Sax FX 1
566. Claps 1	610. Dance 18	654. Sax FX 2
567. Claps 2	611. Dance 19	655. Sax FX 3
568. Snaps	612. Dance 20	656. Blipp
569. Clave	613. Dance 21	657. Buzz Blip
570. Vibraslap	614. Dance 22	658. Game
571. Guiro	615. Dance 23	659. Dissss

Instrument Listing

660.	Siren Loop	705.	Gtr Wawa 3	750.	Wazzup?
661.	Bell	706.	Gtr Wawa 4	751.	Barker
662.	Klank	707.	Gtr Wawa 5	752.	Plunger
663.	Metal	708.	Gtr Wawa 6	753.	Skipper
664.	Slinky Q	709.	Heavy Guitar	754.	Fast
665.	Space Whip	710.	HeavyGtrDive	755.	Kick 1
666.	Short Quack	711.	Drum Stab	756.	Kick 2
667.	Quack Ahhh	712.	Guit On It	757.	Kick 3
668.	Bowser Bark	713.	Jazz Short	758.	Kick 4
669.	Chiffin	714.	Blamp	759.	Kick 5
670.	CMI Hot Air	715.	Bass Slide	760.	Kick 6
671.	L9000 Noise	716.	Hip Hop	761.	Kick 7
672.	Comon Vox	717.	Drum Stall	762.	Kick 8
673.	Odd Vox	718.	Stalled	763.	Kick 9
674.	Mmm Hmm	719.	Wind Down 1	764.	Kick 10
675.	Ah Hah	720.	Wind Down 2	765.	Kick 11
676.	EP Roll 1	721.	Ripped	766.	Kick 12
677.	EP Roll 2	722.	Space Wiggle	767.	Kick 13
678.	EP Roll 3	723.	Sqweal Rev	768.	Kick 14
679.	EP Fog	724.	Draggit	769.	Kick 15
680.	Fat Low Syn	725.	MC	770.	Kick 16
681.	Bass Stab 1	726.	Fun	771.	Kick 17
682.	Bass Stab 2	727.	SSSSystem 1	772.	Kick 18
683.	Gtr Hi Chuck	728.	SSSSystem 2	773.	Kick 19
684.	Gtr UpStroke	729.	Here	774.	Kick 20
685.	Gtr Scratch1	730.	On It	775.	Kick 21
686.	Gtr Scratch2	731.	Diss	776.	Kick 22
687.	KleanGtrChuk	732.	Bow Wow	777.	Kick 23
688.	Gtr Jangle	733.	Diva Scratch	778.	Kick 24
689.	Gtr Riff 1	734.	Organ Blip	779.	Kick 25
690.	Gtr Riff 2	735.	Classic Tape	780.	Kick 26
691.	Gtr Riff 3	736.	Out!	781.	Kick 27
692.	Gtr FunkyHit	737.	Punch It	782.	Kick 28
693.	Another Gtr	738.	Ork	783.	Kick 29
694.	Jazz Riff 1	739.	Tape Stop	784.	Kick 30
695.	Jazz Riff 2	740.	Zip	785.	Kick 31
696.	Jazz Riff 3	741.	Tape Pull	786.	Kick 32
697.	GtrSlideRiff	742.	Wild	787.	Kick 33
698.	Gtr PopSlide	743.	Up	788.	Kick 34
699.	Guitar Pop	744.	Away	789.	Kick 35
700.	Chord Chuck	745.	Frenzy	790.	Kick 36
701.	Guitar Slide	746.	Kick 1	791.	Kick 37
702.	Sad Guitar	747.	Kick 2	792.	Kick 38
703.	Gtr Wawa 1	748.	Snare	793.	Kick 39
704.	Gtr Wawa 2	749.	Tite	794.	Kick 40

Instrument Listing

795. Kick 41	839. Snare 28	883. Snare 72
796. Kick 42	840. Snare 29	884. Snare 73
797. Kick 43	841. Snare 30	885. Snare 74
798. Kick 44	842. Snare 31	886. Snare 75
799. Kick 45	843. Snare 32	887. Snare 76
800. Kick 46	844. Snare 33	888. Snare 77
801. Kick 47	845. Snare 34	889. Snare 78
802. Kick 48	846. Snare 35	890. Snare 79
803. Kick 49	847. Snare 36	891. Snare 80
804. Kick 50	848. Snare 37	892. Snare 81
805. Kick 51	849. Snare 38	893. Snare 82
806. Kick 52	850. Snare 39	894. Snare 83
807. Kick 53	851. Snare 40	895. Snare 84
808. Kick 54	852. Snare 41	896. Snare 85
809. Kick 55	853. Snare 42	897. Snare 86
810. Kick 56	854. Snare 43	898. Snare 87
811. Kick 57	855. Snare 44	899. Snare 88
812. Snare 1	856. Snare 45	900. Snare 89
813. Snare 2	857. Snare 46	901. Snare 90
814. Snare 3	858. Snare 47	902. Snare 91
815. Snare 4	859. Snare 48	903. Snare 92
816. Snare 5	860. Snare 49	904. Snare 93
817. Snare 6	861. Snare 50	905. Snare 94
818. Snare 7	862. Snare 51	906. Snare 95
819. Snare 8	863. Snare 52	907. Snare 96
820. Snare 9	864. Snare 53	908. Snare 97
821. Snare 10	865. Snare 54	909. Snare 98
822. Snare 11	866. Snare 55	910. Snare 99
823. Snare 12	867. Snare 56	911. Snare 100
824. Snare 13	868. Snare 57	912. Snare 101
825. Snare 14	869. Snare 58	913. Snare 102
826. Snare 15	870. Snare 59	914. Snare 103
827. Snare 16	871. Snare 60	915. Snare 104
828. Snare 17	872. Snare 61	916. Snare 105
829. Snare 18	873. Snare 62	917. Snare 106
830. Snare 19	874. Snare 63	918. Tom 1
831. Snare 20	875. Snare 64	919. Tom 2
832. Snare 21	876. Snare 65	920. Tom 3
833. Snare 22	877. Snare 66	921. Tom 4
834. Snare 23	878. Snare 67	922. Tom 5
835. Snare 24	879. Snare 68	923. Tom 6
836. Snare 25	880. Snare 69	924. Tom 7
837. Snare 26	881. Snare 70	925. Tom 8
838. Snare 27	882. Snare 71	926. Tom 9

Instrument Listing

927. Tom 10	971. Hat 5	1015. Hat 49
928. Tom 11	972. Hat 6	1016. Hat 50
929. Tom 12	973. Hat 7	1017. Hat 51
930. Tom 13	974. Hat 8	1018. Hat 52
931. Tom 14	975. Hat 9	1019. Hat 53
932. Tom 15	976. Hat 10	1020. Hat 54
933. Tom 16	977. Hat 11	1021. Hat 55
934. Tom 17	978. Hat 12	1022. Hat 56
935. Tom 18	979. Hat 13	1023. Hat 57
936. Tom 19	980. Hat 14	1024. Hat 58
937. Tom 20	981. Hat 15	1025. Hat 59
938. Tom 21	982. Hat 16	1026. Hat 60
939. Tom 22	983. Hat 17	1027. Hat 61
940. Tom 23	984. Hat 18	1028. Hat 62
941. Tom 24	985. Hat 19	1029. Hat 63
942. Tom 25	986. Hat 20	1030. Hat 64
943. Tom 26	987. Hat 21	1031. Hat 65
944. Timbale 1	988. Hat 22	1032. Hat 66
945. Timbale 2	989. Hat 23	1033. Hat 67
946. Timbale 3	990. Hat 24	1034. Hat 68
947. Timbale 4	991. Hat 25	1035. Hat 69
948. Timbale 5	992. Hat 26	1036. Hat 70
949. Timbale 6	993. Hat 27	1037. Hat 71
950. Conga 1	994. Hat 28	1038. Hat 72
951. Conga 2	995. Hat 29	1039. Hat 73
952. Conga 3	996. Hat 30	1040. Hat 74
953. Conga 4	997. Hat 31	1041. Hat 75
954. Conga 5	998. Hat 32	1042. Hat 76
955. Conga 6	999. Hat 33	1043. Hat 77
956. Conga 7	1000. Hat 34	1044. Hat 78
957. Conga 8	1001. Hat 35	1045. Cymbal 1
958. Conga 9	1002. Hat 36	1046. Cymbal 2
959. Conga 10	1003. Hat 37	1047. Cymbal 3
960. Bongo 1	1004. Hat 38	1048. Cymbal 4
961. Bongo 2	1005. Hat 39	1049. Cymbal 5
962. Bongo 3	1006. Hat 40	1050. Cymbal 6
963. Bongo 4	1007. Hat 41	1051. Cymbal 7
964. Bongo 5	1008. Hat 42	1052. Cymbal 8
965. Bongo 6	1009. Hat 43	1053. Cymbal 9
966. Bongo 7	1010. Hat 44	1054. Cymbal 10
967. Hat 1	1011. Hat 45	1055. Cymbal 11
968. Hat 2	1012. Hat 46	1056. Cymbal 12
969. Hat 3	1013. Hat 47	1057. Cymbal 13
970. Hat 4	1014. Hat 48	1058. Cymbal 14

Instrument Listing

1059.	Cymbal 15	1104.	Bell 11	1149.	Clap 5
1060.	Cymbal 16	1105.	Bell 12	1150.	Clap 6
1061.	Cymbal 17	1106.	Bell 13	1151.	Clap 7
1062.	Cymbal 18	1107.	Bell 14	1152.	Clap 8
1063.	Shaker 1	1108.	Bell 15	1153.	Clap 9
1064.	Shaker 2	1109.	Bell 16	1154.	Clap 10
1065.	Shaker 3	1110.	Bell 17	1155.	Clap 11
1066.	Shaker 4	1111.	Bell 18	1156.	Clap 12
1067.	Shaker 5	1112.	Bell 19	1157.	Clap 13
1068.	Shaker 6	1113.	Bell 20	1158.	Clap 14
1069.	Shaker 7	1114.	Bell 21	1159.	Clap 15
1070.	Shaker 8	1115.	Bell 22	1160.	Clap 16
1071.	Shaker 9	1116.	Bell 23	1161.	Clap 17
1072.	Shaker 10	1117.	Bell 24	1162.	Snap 1
1073.	Shaker 11	1118.	Bell 25	1163.	Snap 2
1074.	Shaker 12	1119.	Bell 26	1164.	Snap 3
1075.	Shaker 13	1120.	Bell 27	1165.	Snap 4
1076.	Shaker 14	1121.	Bell 28	1166.	Snap 5
1077.	Shaker 15	1122.	Bell 29	1167.	Snap 6
1078.	Shaker 16	1123.	Bell 30	1168.	Misc 1
1079.	Shaker 17	1124.	Bell 31	1169.	Misc 2
1080.	Shaker 18	1125.	Block 1	1170.	Misc 3
1081.	Shaker 19	1126.	Block 2	1171.	Misc 4
1082.	Shaker 20	1127.	Block 3	1172.	Misc 5
1083.	Shaker 21	1128.	Block 4	1173.	Misc 6
1084.	Shaker 22	1129.	Block 5	1174.	Misc 7
1085.	Shaker 23	1130.	Block 6	1175.	Misc 8
1086.	Shaker 24	1131.	Block 7	1176.	Misc 9
1087.	Shaker 25	1132.	Block 8	1177.	Misc 10
1088.	Shaker 26	1133.	Block 9	1178.	Misc 11
1089.	Shaker 27	1134.	Block 10	1179.	Misc 12
1090.	Vibraslap	1135.	Block 11	1180.	Misc 13
1091.	Flexitone	1136.	Block 12	1181.	Misc 14
1092.	Bell Tree	1137.	Tam 1	1182.	Misc 15
1093.	Slay Bells	1138.	Tam 2	1183.	Misc 16
1094.	Bell 1	1139.	Tam 3	1184.	Misc 17
1095.	Bell 2	1140.	Tam 4	1185.	Misc 18
1096.	Bell 3	1141.	Tam 5	1186.	Misc 19
1097.	Bell 4	1142.	Tam 6	1187.	Misc 20
1098.	Bell 5	1143.	Tam 7	1188.	Misc 21
1099.	Bell 6	1144.	Tam 8	1189.	Misc 22
1100.	Bell 7	1145.	Clap 1	1190.	Misc 23
1101.	Bell 8	1146.	Clap 2	1191.	Misc 24
1102.	Bell 9	1147.	Clap 3	1192.	Misc 25
1103.	Bell 10	1148.	Clap 4	1193.	Misc 26

Instrument Listing

1194. Misc 27
1195. Misc 28
1196. Misc 29
1197. Misc 30
1198. Misc 31
1199. Misc 32

1200. Misc 33
1201. Misc 34
1202. Misc 35
1203. Misc 36
1204. Misc 37
1205. Misc 38

1206. Misc 39
1207. Misc 40
1208. Misc 41
1209. Misc 42
1210. Misc 43

Riff Listing

- | | | |
|----------------------|--------------------------|-------------------------|
| 1. KEY-C3.mid | 45. BTS-Dark Hero 1 | 89. HIT-Enrezzle |
| 2. AIR-Bat Pann | 46. BTS-Dist Treo 1 | 90. HIT-Guit Hits |
| 3. AIR-Breathless | 47. BTS-DoFi 1 | 91. HIT-Orgy Hitts |
| 4. AIR-Futura | 48. BTS-Drumatic 1.mid | 92. HIT-Tite |
| 5. BAS-1 Shot | 49. BTS-Elbowroom 1 | 93. KEY-C Triad.mid |
| 6. BAS-2600x | 50. BTS-Europiavis1 | 94. KEY-C2 (2 Bars) |
| 7. BAS-3O3x | 51. BTS-Frantikk 1.mid | 95. KEY-C2 (4 Bars) |
| 8. BAS-Acid Mono | 52. BTS-Ginger 1 | 96. KEY-C3 (2 Bars).mid |
| 9. BAS-BadTubex | 53. BTS-Groove II 1 | 97. KEY-C3 (4 Bars).mid |
| 10. BAS-Bullit | 54. BTS-Groove IT 1 | 98. KEY-C4.mid |
| 11. BAS-Dist TB1 | 55. BTS-HBtoo 3 | 99. KEY-Cm7.mid |
| 12. BAS-DistortoTBx | 56. BTS-Heaven 3 | 100. KEY-Cm9.mid |
| 13. BAS-DoFi | 57. BTS-HiHo 1 | 101. KEY-Cmaj7.mid |
| 14. BAS-Filter 1 | 58. BTS-Indy-T 1 | 102. KEY-CUp-Down.mid |
| 15. BAS-Filter 2 | 59. BTS-Jump Hard 1 | 103. KEY-Cs Up.mid |
| 16. BAS-Filter 3 | 60. BTS-Kraftwork 1 | 104. KEY-DxJx |
| 17. BAS-Heavy M | 61. BTS-L-101 1 | 105. KEY-Groove |
| 18. BAS-Interfear | 62. BTS-Light-R 1.smf | 106. KEY-Organik |
| 19. BAS-Lo-Za | 63. BTS-Lo-Z 1 | 107. KEY-Synhiss |
| 20. BAS-Metal Heartx | 64. BTS-LoFi 1 | 108. KIT-80's 4track |
| 21. BAS-Mini Morex | 65. BTS-Logic1 | 109. KIT-Boom 4track |
| 22. BAS-Pdg | 66. BTS-Mind Game 2 | 110. KIT-Compre 4track |
| 23. BAS-Q Bassx | 67. BTS-Mind Game 3 | 111. KIT-Dirt 5track |
| 24. BAS-SE Microx | 68. BTS-Peak777 1 | 112. KIT-G 4track |
| 25. BAS-Say Whatx | 69. BTS-Perception 1 | 113. KIT-Hide 4track |
| 26. BAS-Shiftx | 70. BTS-RollerGirl 1.mid | 114. KIT-K'werk 4track |
| 27. BAS-Sub Corex | 71. BTS-Rush 1 | 115. KIT-Mant 4track |
| 28. BEL-Bellsa | 72. BTS-Semi-Time 2 | 116. LED-Boxt mono |
| 29. BEL-Modular | 73. BTS-System X 1 | 117. LED-Krane |
| 30. BEL-Mystery | 74. BTS-TeknoTribe 1 | 118. LED-More S |
| 31. BPM-Boogy | 75. BTS-The Beast 1.mid | 119. LED-Tunnel |
| 32. BPM-Bounce | 76. BTS-Trancer 1 | 120. LED-Wet |
| 33. BPM-UnderC | 77. BTS-TranzAmbient | 121. NSE-LucyF |
| 34. BTS-007 1 | 78. BTS-Unhooked 1 | 122. PAD-BP Strings |
| 35. BTS-4am flyin 1 | 79. BTS-X-Mox 1.smf | 123. PAD-Danube |
| 36. BTS-808 Street 1 | 80. BTS-Xie-racy 1 | 124. PAD-Dark City |
| 37. BTS-Acid 1 | 81. BTS-HI-NRG | 125. PRC-Construct |
| 38. BTS-Big Body 1 | 82. BTS-Trance Date 1 | 126. PRC-Crash Head |
| 39. BTS-Big Shaker 1 | 83. BTS-Club it 1 | 127. RAW-Drama |
| 40. BTS-BlackHouse1 | 84. BTS-Lily's Rage | 128. SYN- 7064 |
| 41. BTS-D&B Smooth 2 | 85. BTS-Rocket | 129. SYN-4 track a |
| 42. BTS-D&B Tight 1 | 86. EDG-Boxt filter | 130. SYN-4 track b |
| 43. BTS-D-House 1 | 87. EDG-FilterQ | 131. SYN-Basic |
| 44. BTS-DJ-A.mid | 88. GTR-Chuckinx | 132. SYN-Compu X |

Riff Listing

- | | | |
|-----------------------|-----------------------|-----------------------|
| 133. SYN-Enviroment | 177. BTS-Trance Date | 221. BTS-RollerGirl 1 |
| 134. SYN-Grind Me | 178. BTS-Trancer 1 | 222. BTS-Rush 1 |
| 135. SYN-Nordica | 179. BTS-TranzAmbient | 223. BTS-Semi-Time 2 |
| 136. SYN-Octivate | 180. BTS-Unhooked 1 | 224. BTS-System X 1 |
| 137. SYN-Orion | 181. BTS-X-Mox 3 | 225. BTS-TeknoTribe 1 |
| 138. SYN-Quadra | 182. BTS-Xie-racy 1 | 226. BTS-The Beast 1 |
| 139. SYN-Saint | 183. SYN-Enviroment | 227. BTS-Trance Date |
| 140. SYN-Sinner | 184. SYN-Grind Me | 228. BTS-Trancer 1 |
| 141. SYN-South E2 | 185. SYN-Nordica | 229. BTS-TranzAmbient |
| 142. SYN-Tran 3track | 186. SYN-Octivate | 230. BTS-Unhooked 1 |
| 143. SYN-Tripper | 187. SYN-Orion | 231. BTS-X-Mox 3 |
| 144. VOX-Bliss | 188. SYN-Quadra | 232. BTS-Xie-racy 1 |
| 145. VOX-Zephr | 189. SYN-Saint | 233. SYN-Enviroment |
| 146. WAL-Abyss | 190. SYN-Sinner | 234. SYN-Grind Me |
| 147. WAL-CRide | 191. SYN-South E2 | 235. SYN-Nordica |
| 148. WAL-Love 2bee | 192. SYN-Tran 3track | 236. SYN-Octivate |
| 149. WAL-Mammoth | 193. SYN-Tripper | 237. SYN-Orion |
| 150. WAL-Raverot | 194. VOX-Bliss | 238. SYN-Quadra |
| 151. XTR-Booty Q | 195. VOX-Zephr | 239. SYN-Saint |
| 152. BTS-C-Man | 196. WAL-Abyss | 240. SYN-Sinner |
| 153. BTS-Humana | 197. WAL-CRide | 241. SYN-South E2 |
| 154. BTS--Indy-T 1 | 198. WAL-Love 2bee | 242. SYN-Tran 3track |
| 155. BTS-Jump Hard 1 | 199. WAL-Mammoth | 243. SYN-Tripper |
| 156. BTS-Kraftwork 1 | 200. WAL-Raverot | 244. VOX-Bliss |
| 157. BTS-L-101 1 | 201. XTR-Booty Q | 245. VOX-Zephr |
| 158. BTS-Light-R 2 | 202. BTS-C-Man | 246. WAL-Abyss |
| 159. BTS-Lily's Rage | 203. BTS-Humana | 247. WAL-CRide |
| 160. BTS-Lo-Z 1 | 204. BTS--Indy-T 1 | 248. WAL-Love 2bee |
| 161. BTS-LoFi 1 | 205. BTS-Jump Hard 1 | 249. WAL-Mammoth |
| 162. BTS-Logic1 | 206. BTS-Kraftwork 1 | 250. WAL-Raverot |
| 163. BTS-Metallic | 207. BTS-L-101 1 | 251. XTR-Booty Q |
| 164. BTS-Mind Game 2 | 208. BTS-Light-R 2 | 252. BTS-C-Man |
| 165. BTS-Mind Game 3 | 209. BTS-Lily's Rage | 253. BTS-Humana |
| 166. BTS-Organic Cube | 210. BTS-Lo-Z 1 | 254. BTS--Indy-T 1 |
| 167. BTS-Peak777 1 | 211. BTS-LoFi 1 | 255. BTS-Jump Hard 1 |
| 168. BTS-Perception 1 | 212. BTS-Logic1 | 256. BTS-Kraftwork 1 |
| 169. BTS-placeholder | 213. BTS-Metallic | 257. BTS-L-101 1 |
| 170. BTS-Rocket | 214. BTS-Mind Game 2 | 258. BTS-Light-R 2 |
| 171. BTS-RollerGirl 1 | 215. BTS-Mind Game 3 | 259. BTS-Lily's Rage |
| 172. BTS-Rush 1 | 216. BTS-Organic Cube | 260. BTS-Lo-Z 1 |
| 173. BTS-Semi-Time 2 | 217. BTS-Peak777 1 | 261. BTS-LoFi 1 |
| 174. BTS-System X 1 | 218. BTS-Perception 1 | 262. BTS-Logic1 |
| 175. BTS-TeknoTribe 1 | 219. BTS-placeholder | 263. BTS-Metallic |
| 176. BTS-The Beast 1 | 220. BTS-Rocket | 264. BTS-Mind Game 2 |

Riff Listing

- | | | |
|------------------------------|--------------------------------|------------------------------|
| 265. BTS-Mind Game 3 | 287. BTS-Pulverize | 309. BTS-Smoking Room |
| 266. BTS-Organic Cube | 288. BTS-ToTheJR | 310. BTS-Edgy |
| 267. BTS-Peak777 1 | 289. BTS-1983 | 311. BTS-Voxer |
| 268. BTS-Perception 1 | 290. BTS-HighRise | 312. BTS-Inspiration |
| 269. BTS-placeholder | 291. BTS-HorrorTime | 313. BTS--Nu Space 7 |
| 270. BTS-Rocket | 292. BTS-Junkyard | 314. BTS-2X1-2TimeD&B |
| 271. BTS-RollerGirl 1 | 293. BTS-LeaveItAlone | 315. BTS-Boomstick |
| 272. BTS-Rush 1 | 294. BTS-LuvinDa3Way | 316. BTS-Buck Funk |
| 273. BTS-Semi-Time 2 | 295. BTS-Mr.Logic | 317. BTS-Deepdownlowd |
| 274. BTS-System X 1 | 296. BTS-PimpinItHard | 318. BTS-Deph Break |
| 275. BTS-TeknoTribe 1 | 297. BTS-Planet E-mu | 319. BTS-Dodecahedron |
| 276. BTS-The Beast 1 | 298. BTS-Shopping Spree | 320. BTS-Euro House |
| 277. BTS-Trance Date | 299. BTS-UBradeRunner | 321. BTS-Garage Style |
| 278. BTS-Trancer 1 | 300. BTS-a la Rock | 322. BTS-Magic Air |
| 279. BTS-TranzAmbient | 301. BTS-Avenger | 323. BTS-NubChompa! |
| 280. BTS-Unhooked 1 | 302. BTS-Broken Kit | 324. BTS-Sassafras |
| 281. BTS-X-Mox 3 | 303. BTS-Euro Beatz | 325. BTS-Space Race |
| 282. BTS-Xie-racy 1 | 304. BTS-Feelin House | 326. BTS-Stadium Btz |
| 283. BTS-AndroBot | 305. BTS-Hard Anthem | 327. BTS-Underwhirl |
| 284. BTS-Anthem | 306. BTS-House Groove | 328. BTS-Gothica |
| 285. BTS-BrickLayer | 307. BTS-Liquid Cycle | 329. BTS-Leader |
| 286. BTS-OutCold | 308. BTS-Night Ride | 330. BTS-Metro |
| | | 331. BTS-Sparkler |

Keyboard Velocity Curves



For more information about the velocity curves, see page 73.

The keyboard velocity curves modify the response of the XK-6 keyboard to adapt to your personal playing style. The “Keyboard Velocity Curve” selection screen is located in the Controllers menu.

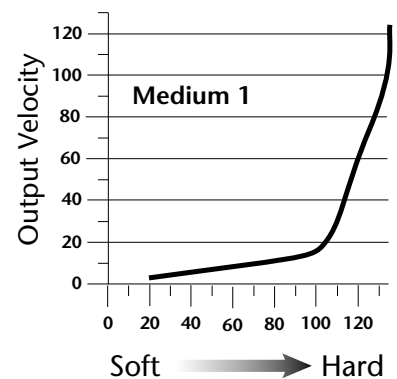
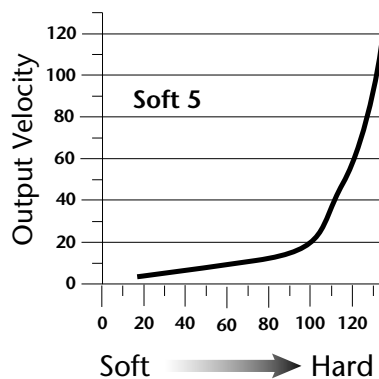
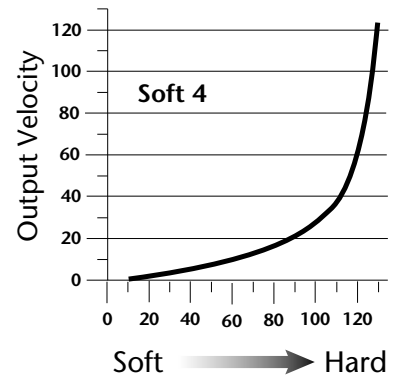
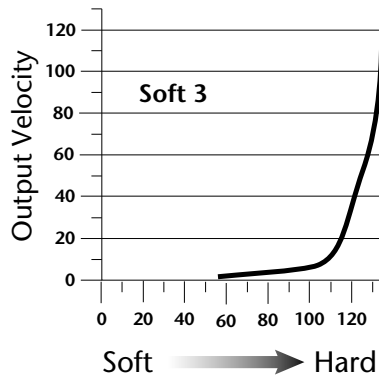
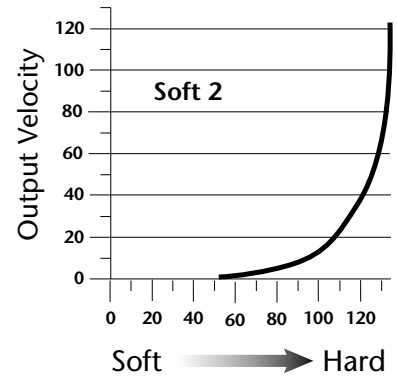
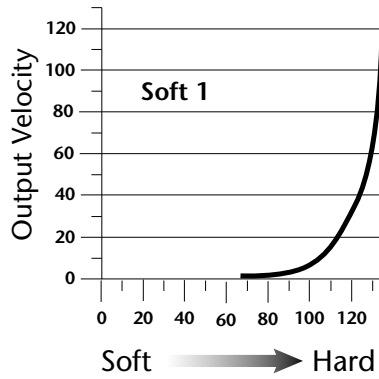

Keyboard Velocity
Curves

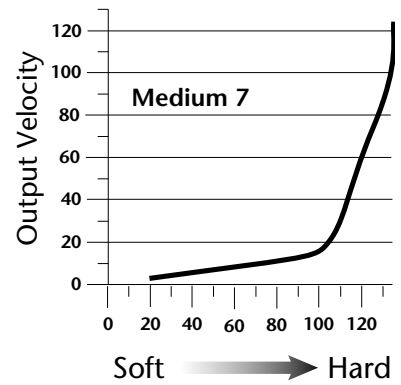
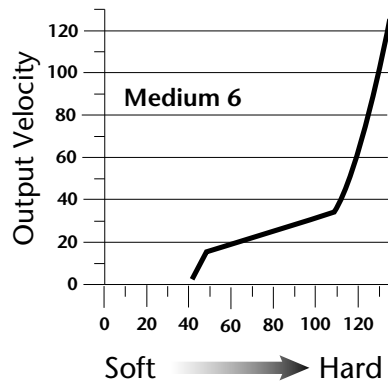
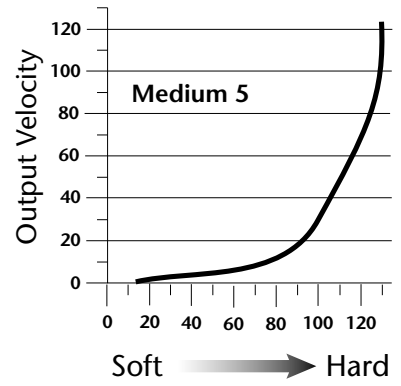
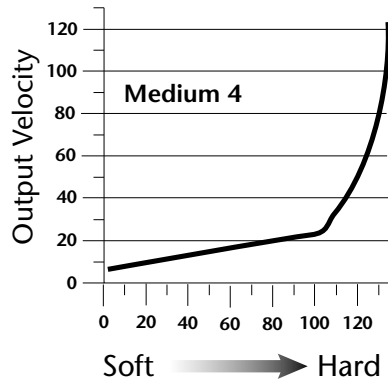
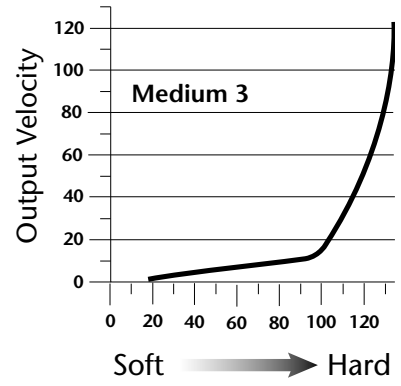
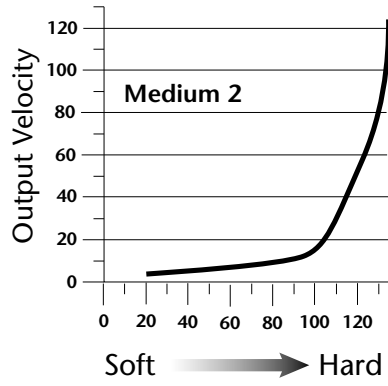

Keyboard Velocity
Curves

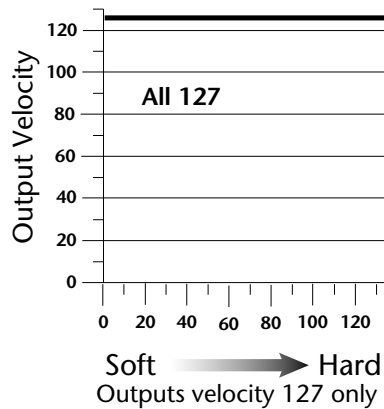
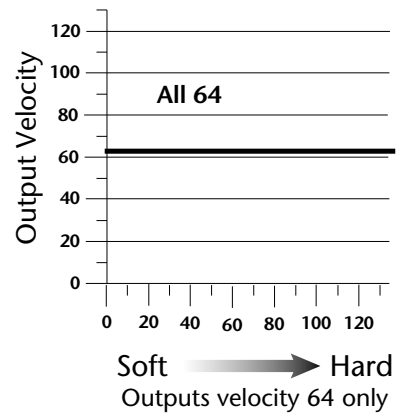
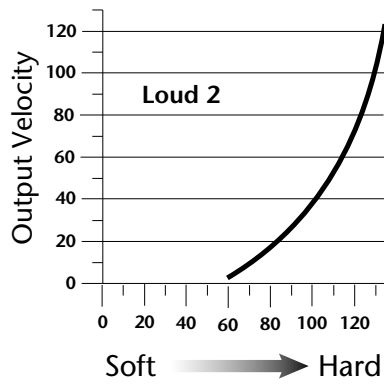
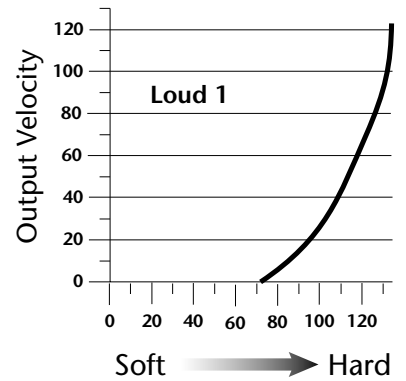
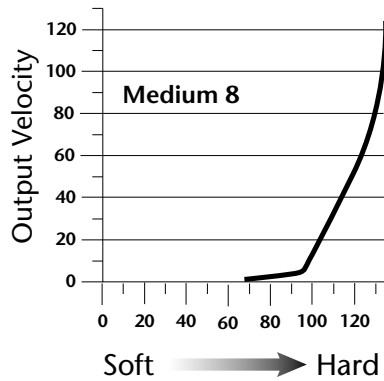

Master Velocity Curves

 For more information about the velocity curves, see page 73.

This section provides diagrams and descriptions of the XK-6 velocity curves. The master velocity curves modify the velocity values from the MIDI input port and the keyboard before going into the synthesizer engine.

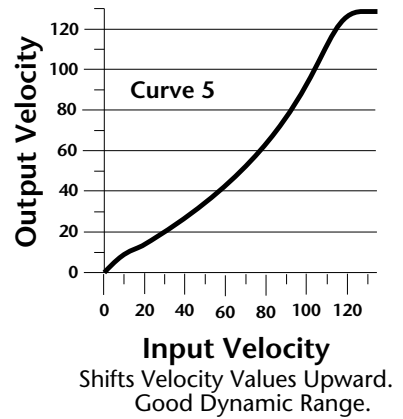
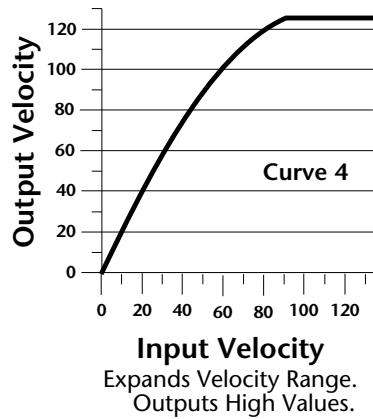
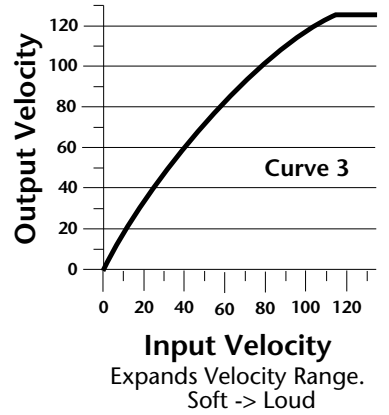
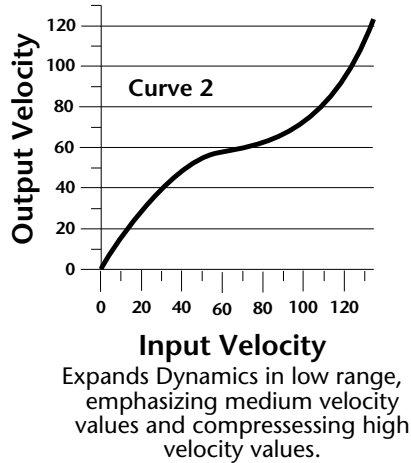
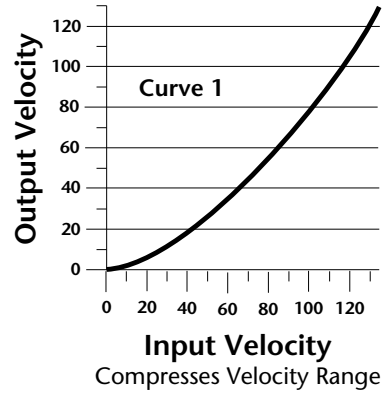
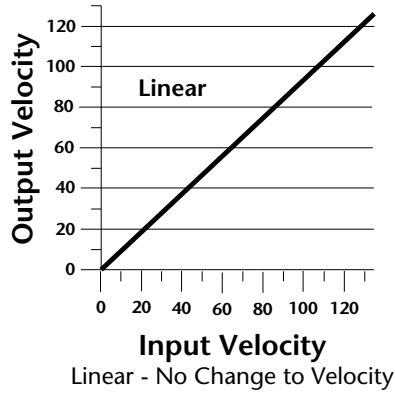

Master Velocity
Curves

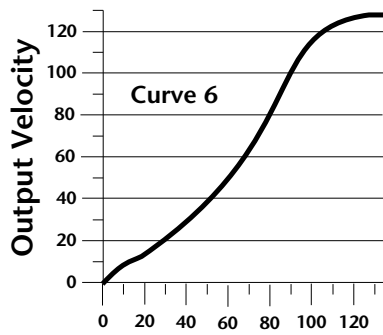

Curve 6
Shifts Velocity Values Up, while
compressing the middle range

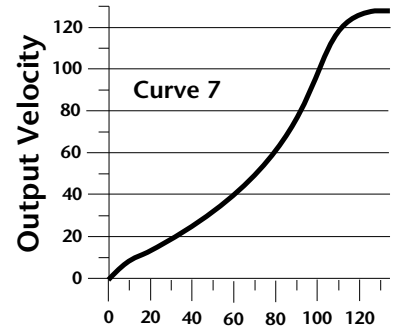

Curve 7
Similar to Curve 6.

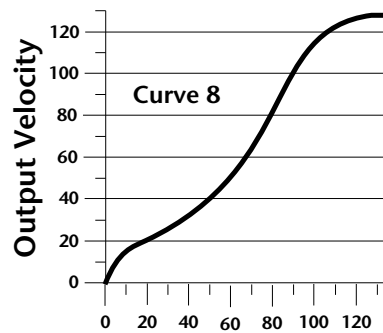

Curve 8
Similar to number 6 with more
emphasis on the middle range.

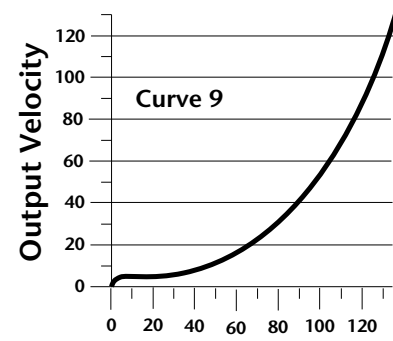

Curve 9
Extreme Dynamic Range
Compression.

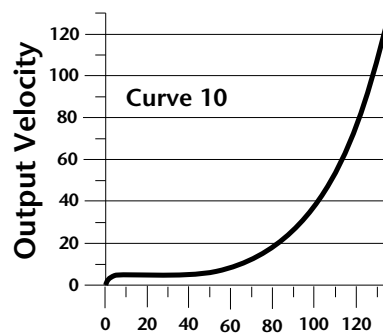

Curve 10
Extreme Dynamic Range
Compression. Outputs Low Values.

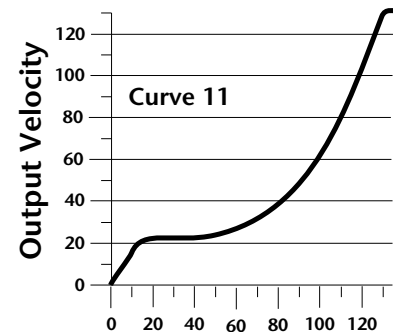

Curve 11
Extreme Dynamic Range
Compression, but doesn't
output low values.

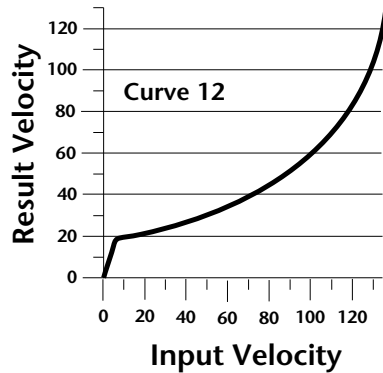

Less Severe Version of Curve 11.

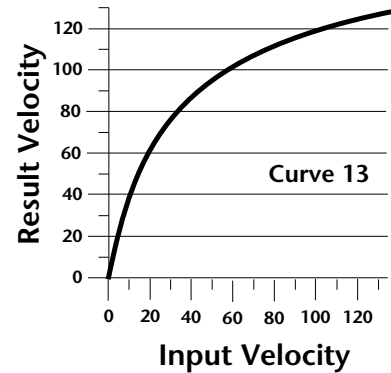

Extreme Expansion of Velocity Range.

PatchCord Amount Chart

The following chart shows the PatchCord “Amount” settings in order to get semitone intervals when modulation sources are connected to pitch.

Semitone	PatchCord Amount	Semitone	PatchCord Amount
1	3	21	66
2	6	22	69
3	approx. 9	23	approx. 72.5
4	approx. 12	24	approx. 76
5	16	25	79
6	19	26	82
7	22	27	88
8	25	28	91
9	28	29	approx. 95
10	approx. 31	30	98
11	35	31	
12	38	32	
13	41	33	
14	44	34	
15	47	35	
16	50	36	
17	approx. 53	37	
18	57	38	
19	60	39	
20	63	40	

E-MU Expansion Sound Sets



Eleven different ROM expansions are currently available, with more being developed every day. ROM expansions typically add 32MB of sound data and 512 additional presets. Adding new sounds is like getting a new instrument and a sure way to spark your creativity. ROM Expansions are available from your E-MU dealer. Also check out the official E-MU website: www.emu.com for the latest sounds.

Orchestral Sessions VOLUME 1

The Orchestral Sessions Vol. 1 expansion 32 MB ROM offers you the most realistic and comprehensive collection of section strings available, complete with legato, spiccato, pizzicato and tremolande samples, and includes special presets for 4 speaker applications.



Orchestral Sessions VOLUME 2

The Orchestral Sessions Vol. 2 expansion 32 MB ROM offers you the most realistic and comprehensive collection of woodwinds, brass, percussion, and solo strings available, complete with velocity switching between p/mf/ff samples, special presets for 4 speaker applications and a percussion battery with over 20 instruments.



Siedlaczek Orchestra Special Edition

The Peter Siedlaczek Advanced Orchestra Special Edition puts 32 MB of his finest ensembles onto a single expansion ROM for your XK-6. String, brass, woodwind and percussion ensembles are included in a variety of styles (i.e. vibrato, tremolo, pizzicato, sordino, etc.), to give you a diverse collection of samples.



Protozoa

E-MU presents the 16 MB Protozoa expansion ROM—the ultimate sound compilation containing presets from the ground breaking Proteus sound modules, all optimized for your XK-6's advanced synthesis and filter architecture.



Sounds of the ZR

The Sounds of the ZR Expansion ROM faithfully reproduces the diverse sounds of ENSONIQ's popular ZR-76 keyboard, including William Coakley's Perfect Piano. You'll find everything from synths and orchestral instruments to one of the finest pianos ever sampled in one soundset.



Definitive B-3

John Novello and E-MU present the 32 MB Definitive B-3 expansion ROM, a diverse collection of tone wheel organ drawbar settings sampled direct and with rotary speakers (chorale and tremolo) to give you the most versatile and playable B-3 available!

X-Lead

The X-Lead soundset consists primarily of analog, noise and modern synthesizer waveforms. These sounds are rich in harmonic texture and are a perfect match with the Z-plane filters in your Proteus® family sound module. With the included software upgrade, you now have access to dynamic and rhythmic features not found on any other instrument.



PURE PHATT

The 32 MB Pure Phatt is E-MU's latest Hip-Hop soundset that produces the freshest and newest sounds and grooves from top notch producers from the East, Southeast and West coasts. Pumping leads and basses, silky pads and those unique hits, scratches and drones that your mix needs to bring it to the next level are ready to provide the love.



World Expedition

An amazing collection of traditional instruments from the four corners of the globe including exotic stringed instruments, winds, percussion, and chromatic percussion. World Expedition provides you with the most realistic ethnic soundset in the world. Discover a world of sounds to bring to your music.



Techno Synth

Rob Papen and E-MU introduce the 32 MB Techno Synth Construction Yard Expansion ROM, a compilation of synth, techno, and ambient sounds from one of Europe's finest programmers. From atmospheric pads to punchy sub-basses and crunch drum loops, these sounds will help you tear up the dance floor!



Beat Garden

Dutch sound designer Rob Papen and E-MU introduce the 32 MB Beat Garden expansion ROM, a diverse palette of all-new Electronica/Dance beats, synths, basses, drumkits, acoustic and electronic percussion. Experience the Beat Garden for yourself and add a unique dimension to your tracks.

Installing Sound SIMMs

XK-6 can be easily expanded to contain up to 128 MB of sound data (4 SIMMs).

► Remove the ROM Hatch Cover:

1. The sound SIMM sockets in XK-6 are located beneath a small hatch on the bottom panel. Unplug power from the unit and carefully turn it keyboard-side down on a soft, padded surface.
2. The ROM hatch is a 125cm x 140cm rectangle secured by four screws. (*You can't miss it.*) Remove the four phillips head screws securing this hatch and place them and the hatch cover where they won't get lost.

► To Remove ROM SIMMs (if necessary):

1. Orient the unit so that the rear panel is facing you. Ground yourself by touching a grounded object. (*Such as the chassis of another piece of equipment connected to the wall socket with a three-prong power plug.*)
2. On each end of the SIMM socket there is a silver or plastic tab. Use a screwdriver or a ball point pen to squeeze the tabs toward the outside of the socket while gently nudging the SIMM toward the right side of the unit. The old SIMM should "hinge" to the right and can now be removed.

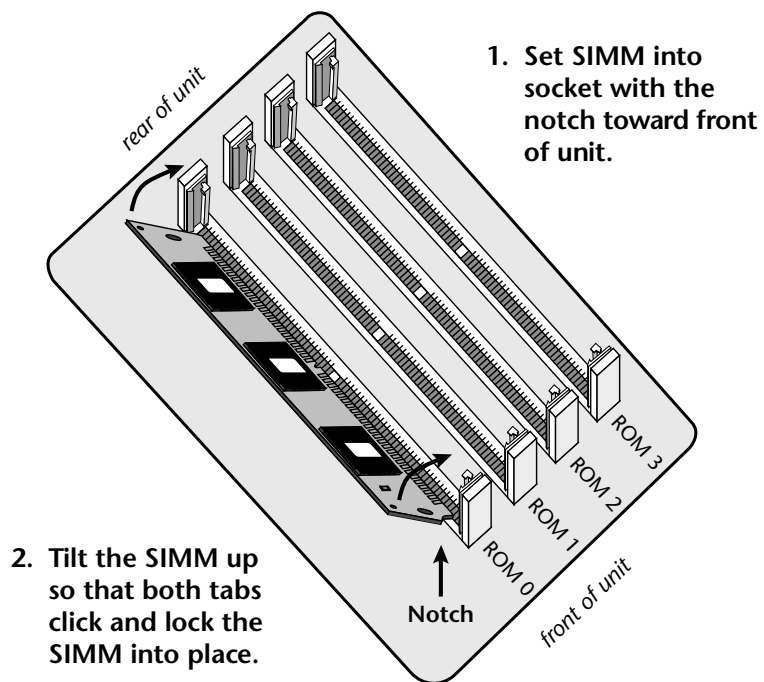

► **Install a New ROM SIMM**

1. Ground yourself by touching a grounded object, then remove the memory SIMM modules from the static protected packaging.
2. Notice that one end of the SIMM connector is notched. This notch should be oriented towards the keyboard side of the unit. Install the SIMM closest to the LEFT side first. (*When the rear of the unit is closest to you.*)
3. Gently set the SIMM deep into the SIMM socket at a 45° angle with the notch toward the keyboard. Without forcing the insertion, let the board rest in the socket as deep as it will go. It should rest naturally in place at this 45° angle. See the following diagrams.
4. While applying a slight downward pressure on the top of the SIMM to keep it from popping out of the socket, tilt the SIMM board into a vertical position. You should hear an audible click. Make sure both sides of the silver tabs have latched.

► **Reassemble the Unit**

5. Replace the hatch cover and the four screws. The screws are all identical.

► **Test It**

The installation is almost finished.

1. Turn the unit right-side up and plug in the power cord.
2. Turn on power.
3. Place the cursor under the ROM field of the Main screen and turn the data entry control to verify that the new sound ROM has been recognized.
4. Play the presets on the new ROM banks and verify that they sound OK.

Problems?

1. Disconnect power immediately.
2. Open the unit, and try re-seating the ROM SIMMs. Take care that the RAM SIMMs are properly installed in the sockets. If you're still having problems, return the unit to its original configuration and call EMU Systems Customer Service at (831) 438-1921. Telephone support hours are 8:00-5:00 PST, Monday through Friday.

MIDI

MIDI Implementation Chart (part 1)

MIDI Information	Transmitted	Recognized	Remarks
MIDI Channels	1-16	1-16	
Note Numbers	0-127	0-127	
Program Change	0-127	0-127	
Bank Select Response?	No	Yes	MSB + LSB
Modes: Omni (<i>Mode 1</i>)	No	Yes	
Mono (<i>Mode 2</i>)	No	Yes	
Poly (<i>Mode 3</i>)	No	Yes	
Mode 4	No	No	
Multi (<i>Mode 5</i>)	No	Yes	
Note On Velocity	Yes	Yes	
Note Off Velocity	No	Yes	
Channel Aftertouch	Yes	Yes	
Poly (Key) Aftertouch	No	No	
Pitch Bend	Yes	Yes	
Active Sensing	No	No	
System Reset	No	No	
Tune Request	No	No	
System Exclusive	Yes	Yes	
Sample Dump Standard	No	No	
File Dump	Yes	Yes	
MIDI Tuning	Yes	Yes	
Master Volume	No	Yes	
Master Balance	No	No	
Notation Information	No	No	
Turn GM1 System On	No	No	
Turn GM2 System On	No	No	
Turn GM1 System Off	No	No	
Other (<i>See Remarks</i>)	No	No	
NRPNs	No	No	
RPN 00 (<i>Pitch Bend Sensi.</i>)	No	No	
RPN 01 (<i>Chan. Fine Tune</i>)	No	No	
RPN 02 (<i>Chan Coar. Tune</i>)	No	No	
RPN 03 (<i>Tuning Prog Sel.</i>)	No	No	
RPN 04 (<i>Tuning Bank Sel.</i>)	No	No	
RPN 05 (<i>Mod Depth Rang</i>)	No	No	
MIDI Timing & Sync			
MIDI Clock	Yes	Yes	
Song Position Pointer	No	No	
Song Select	No	No	
Start	No	Yes	
Continue	No	No	
Stop	No	No	

MIDI Information	Transmitted	Recognized	Remarks
MIDI Time Code	No	No	
MIDI Machine Control	No	No	
MIDI Show Control	No	No	
Extension Capability			
General MIDI Compat?	No	No	
Is GM default mode?	No	No	
DLS compatible?	No	No	
Import DLS Files?	No	No	
Export DLS Files?	No	No	
Import Std MIDI files	No	No	
Export Std MIDI files	No	No	

MIDI Implementation Chart (part 2 - Controllers)

Control #	Function	Transmitted	Recognized	Remarks
0	Bank Select MSB	Yes	Yes	
1	Mod Wheel MSB	Yes	Yes	* see note
2	Breath Cntrl MSB	No	No	* see note
3		No	No	*
4	Foot Cntrl MSB	Yes	No	*
5	Portamento MSB	No	No	*
6	Data Entry MSB	No	No	*
7	Chan Volume MSB	Yes	Yes	*
8	Balance MSB	No	No	*
9				*
10	Pan MSB	Yes	Yes	*
11	Expression MSB	No	Yes	*
12	Effect Cntrl 1 MSB	No	No	*
13	Effect Cntrl 2 MSB	No	No	*
14				*
15				*
16	GenPur Ctrl 1 MSB			*
17	GenPur Ctrl 2 MSB			*
18	GenPur Ctrl 3 MSB			*
19	GenPur Ctrl 4 MSB			*
20				*
21				*
22				*
23				* see note
24				*
25	↔	Yes	Yes	* Filt Attck
26	↔	Yes	Yes	* Filt Decy
27				*
28				*
29				*
30				*
31				*
32	Bank Select LSB	Yes	Yes	*
33	Mod Wheel LSB			*
34	Breath Cntrl LSB			*
35				*
36	Foot Cntrlr LSB	No	No	*

Control #	Function	Transmitted	Recognized	Remarks
37	Portamento LSB			*
38	Data Entry LSB			*
39	Chan Volume LSB			*
40	Balance LSB			*
41				*
42	Pan LSB			*
43	Expression LSB			*
44	Effect Cntrl 1 LSB			*
45	Effect Cntrl 2 LSB			*
46				*
47				*
48	Gen Pur Ctrl 1 LSB			*
49	Gen Pur Ctrl 2 LSB			*
50	Gen Pur Ctrl 3 LSB			*
51	Gen Pur Ctrl 4 LSB			*
52				*
53				*
54				*
55				*
56				*
57				*
58				*
59				*
60				*
61				*
62				*
63				*
64	Sustain Pedal	Yes	Yes	*
65	Portamento on/off	No	No	*
66	Sostenuto	No	No	*
67	Soft Pedal			*
68	Legato Footswitch			*
69	Hold 2			*
70	Variation			*
71	Timbre/Har Inten	Yes	Yes	*
72	Release Time	Yes		*
73	Attack Time	Yes		*
74	Brightness	Yes		*

Control #	Function	Transmitted	Recognized	Remarks
75	Sound Cntrlr 6 ➡	Yes	Yes	* <i>Decay</i>
76	Sound Cntrlr 7			*
77	Sound Cntrlr 8 ➡	Yes	Yes	* <i>Vel->Filt</i>
78	Sound Cntrlr 9 ➡	Yes	Yes	* <i>Vel->amp</i>
79	Sound Cntrlr 10	Yes	Yes	↵ <i>See note</i>
80	Gen Purp Cntrlr 5	Yes	Yes	↵ <i>See note</i>
81	Gen Purp Cntrlr 6			*
82	Gen Pur Cntrlr 7 ➡	Yes	Yes	* <i>Arp Vel</i>
83	Gen Pur Cntrlr 8 ➡	Yes	Yes	* <i>Arp Gate</i>
84	Portamento Cntrl			*
85	➡	Yes	Yes	* <i>Sustain</i>
86				*
87				*
88				*
89				*
90				*
91	Effects 1 Depth	Yes		*
92	Effects 2 Depth			*
93	Effects 3 Depth	Yes		*
94	Effects 4 Depth			*
95	Effects 5 Depth			*
96	Data Increment			
97	Data Decrement			
98	NRPN (LSB)			
99	NRPN (MSB)			
100	RPN (LSB)			
101	RPN (MSB)			
102				
103				
104				
105				
106				
107				
108				
109				
110				
111				
112				

Control #	Function	Transmitted	Recognized	Remarks
113				
114				
115				
116				
117				
118				
119				
120	All Sound Off	No	Yes	☞ See note
121	Reset All Contlr	No	Yes	
122	Local Cntrl on/off	No	No	
123	All Notes Off	No	Yes	
124	Omni Mode Off	No	Yes ★	★ if enabled
125	Omni Mode On	No	Yes ★	★ if enabled
126	Poly Mode Off	No	Yes ★	★ if enabled
127	Poly Mode On	No	Yes ★	★ if enabled
<p>NOTES: * XK-6 can transmit and receive ANY continuous controller number from 1 to 95. Because of XK-6's powerful synth engine, many of the standard MIDI controllers can be user programmed to provide the desired function. A "Yes" response in this chart means that a controller is programmed by default in XK-6.</p> <p>↓ Controller 79 is hard-coded to the Mix Output parameter. 0=Use Preset, 1=Send 1, 2=Send 2, 3=Send 3, 4=Send 4</p> <p>↻ Controller 80 is hard-coded to the Arp Status parameter. 0=Off, 1=On, 2=P (preset), 3=M (master)</p> <p>☞ Value of 0 = reset all except vol & pan; value of 127 = reset all</p> <p>Other: Pan: -64 = hard left, +63 = hard right</p>				

Product ID for XK-6 = 0F (15)

MIDI Device Inquiry Responses

Family

MSB 0x04 (Musical Instruments)

LSB 0x04 (ROM Players)

Members

MSB 0x00 (Proteus 2000 series)

LSB 0x02 Audity 2000
0x03 Proteus 2000
0x04 B-3
0x05 XL-1
0x06 Virtuoso 2000
0x07 Mo'Phatt
0x08 B-3 Turbo
0x09 XL-1 Turbo
0x0A Mo'Phatt Turbo
0x0B Planet Earth
0x0C Planet Earth Turbo
0x0D XL-7
0x0E MP-7
0x0F Proteus 2500
0x10 Orbit 3
0x11 PK-6
0x12 XK-6
0x13 MK-6
0x14 Halo
0x15 Proteus 1000

There is only one edit buffer which is used by the current preset (the preset shown in the display). You can edit only one preset at a time via SysEx commands, although these presets can be edited independently of the current preset edited using the Front Panel. Remote Preset selection is independent of the edit buffer. Changing the current preset erases the edit buffer.

Received Channel Commands

Channels number (n) = 0-15. Message bytes are represented in hex. All other numbers are decimal. Running Status is supported.

Command	Message	Comments
Note Off	8n kk vv	
Note On	9n kk vv	velocity 0 = note off
Program Change	Cn vv	0-127
Channel Aftertouch	Dn vv	0-127
Pitch Bend	En ll mm	l = lsb, m = msb
Real-time Controller	Bn cc vv	cc = 00-31, 64-95
Footswitch	Bn cc vv	cc = 64-79, vv ≥ 64 = on
Volume	Bn 07 vv	0-127
Pan	Bn 0A vv	0=left, 127=right, 64=center
All Sound Off	Bn 78 00	turns all sound off
Reset All Controllers	Bn 79 00	ignored in omni mode
All Notes Off	Bn 7B 00	ignored in omni mode
Omni Mode Off*	Bn 7C 00	forces all notes & controls off
Omni Mode On*	Bn 7D 00	forces all notes & controls off
Mono Mode On (Poly Off)*	Bn 7E 00	forces all notes & controls off
Poly Mode On (Mono Off)*	Bn 7F 00	forces all notes & controls off
Bank Select MSB	Bn 00 bb	bb = bank MSB (see page 126)
Bank Select LSB	Bn 20 bb	bb = bank LSB (see page 126)

* Special Notes:

- **From Omni Mode** Omni Off turns Poly On.
- **From Poly Mode**..... Omni On turns Omni On; Mono On turns Mono On.
- **From Mono Mode** Mono Off turns Poly On; Omni On turns Omni On.
- **From Multi Mode**..... Omni On turns Omni On; Omni Off or Mono Off turns Poly On; Mono On turns Mono On.
- All other changes have no effect.

SysEx Specification

XK-6 contains an extensive set of MIDI SysEx commands. (*Virtually every parameter is controllable via SysEx.*) Because of the size and technical nature of the System Exclusive specification, it is beyond the scope of this manual. The complete SysEx specification for XK-6 will be available soon on the official E-MU Systems, Inc. web site: www.emu.com

Technical Specifications

Audio Channels:	64
MIDI:	MIDI In, MIDI Out, MIDI Thru
MIDI Channels:	16
Presets:	512 user presets. <i>(The number of ROM presets is determined by the sound SIMMs installed.)</i>
Filters:	2nd order to 12th order filters (50 different types)
Audio Outputs:	4 polyphonic analog outputs
Submix Inputs:	2 analog inputs (sum to main outs)
Max. Output Level:	+4 dB
Output Impedance:	1000 Ohms
Sound Memory:	32 MB (expandable to 128 MB)
Data Encoding:	16-bit linear data
Effects Engine:	24-bit internal processing
Sample Playback Rate:	44.1 kHz
Signal to Noise:	>92 dB
Dynamic Range:	>90 dB
Frequency Response:	20 Hz - 20 kHz (+2/-1 dB)
THD + Noise:	< 0.02% (1kHz sine wave, A-weighting)
IMD	< 0.05%
Stereo Phase	Phase Coherent +/- 1° at 1 kHz
Power Consumption:	20 Watts
Voltage Input:	90VAC-260VAC at 50Hz-60Hz

Warranty

Please read this warranty, as it gives you specific legal rights.

Limited Warranty

This product is warranted, to the original consumer purchaser, to be free of all defects in workmanship and materials for a period of one (1) year (warranty period is two (2) years in the European Union, effective Jan-1-2002), from the date of such purchase from an authorized E-MU Systems dealer, provided that: (a) the Warranty Registration Card is filled out and returned to E-MU Systems within 14 days of the purchase date; (b) the E-MU Systems service center is provided a copy of the consumer purchaser's sales receipt; and (c) E-MU Systems has confirmed the validity of the subject unit's serial number.

Warranty Restrictions

Specifically, but without limitation, E-MU Systems does not provide warranty service for:

- Damages due to improper or inadequate maintenance, accident, abuse, misuse, alteration, unauthorized repairs, tampering, or failure to follow normal operating procedures as outlined in the owner's manual;
- Deterioration or damage of the cabinet;
- Damages occurring during any shipment of the unit;
- Any unit which has been modified by anyone other than E-MU Systems.
- Any unit with an invalid or wholly or partially obliterated serial number.

NO OTHER EXPRESS OR IMPLIED WARRANTY IS MADE, AND E-MU SYSTEMS SPECIFICALLY DISCLAIMS ANY IMPLIED WARRANTY OF MERCHANTABILITY, SATISFACTORY QUALITY, AND FITNESS FOR A PARTICULAR PURPOSE. E-MU SYSTEMS'S LIABILITY UNDER WARRANTY IS LIMITED TO REPAIR OR REPLACEMENT OF THE UNIT, OR REFUND, AT EMU'S OPTION. IN NO EVENT WILL E-MU SYSTEMS BE LIABLE FOR LOSS OF REVENUE OR SAVINGS, LOSS OF TIME, INTERRUPTION OF USE, OR ANY OTHER CONSEQUENTIAL, INDIRECT, INCIDENTAL, SPECIAL OR EXEMPLARY DAMAGES.

The foregoing will apply notwithstanding the failure of essential purpose of any remedy provided herein. Some jurisdictions do not allow the exclusion of implied warranties or conditions, or limitations on how long an implied warranty or condition may last, so the above limitations may not apply. This warranty gives you specific legal rights. You may have other rights which vary from jurisdiction to jurisdiction.

How To Obtain Warranty Service

All E-MU Systems products are manufactured with the highest standards of quality. If you find that your unit does require service, it may be done by any authorized E-MU Systems service center. If you are unable to locate a service center in your area, please contact EMU's Service Department at (831) 438-1921. They will either refer you to an authorized service center in your area or ask that you return your unit to the E-MU Systems factory.

When returning your unit to the E-MU Systems factory, you will be issued a Return Merchandise Authorization (RMA) number. Please label all cartons, shipping documents and correspondence with this number.

E-MU Systems suggests you carefully and securely pack your unit for return to the factory. (Do not send the power cord or operation manual.) Send the unit to E-MU Systems, Inc., 1600 Green Hills Road, Scotts Valley, CA 95066. You must pre-pay shipping charges to E-MU Systems.

E-MU Systems will pay return shipping charges. You will be responsible for any damage or loss sustained during shipment in any direction.

3/99



Index

Symbols

- “+” modulation polarity 158
- “±” modulation polarity 158

Numerics

- 19-tone tuning 168
- 1-bar trigger 51
- 2-pole filters 120
- 4-pole filters 120
- 6-pole filters 120

A

- A effect types 175, 176
- Absolute Value Processor 109
- AC Receptacle 14
- ADSR Envelopes 201
- Aftertouch
 - calibration 80
 - mono 101
 - on/off 74
- Algorithm
 - FXA 177, 178
 - FXB 177, 179
 - master FXA 89
 - master FXB 90
- All Layers 129, 131
- All Notes Off, MIDI 31
- All Sound Off, MIDI command 31
- Alternate Tunings 92, 168
- Amount
 - patchcord 124, 157
- Amplifier 141
- Amplitude 148, 201
 - envelope 142
 - modulation 100
- Arpeggiator 39
 - button 31
 - channel 39
 - controllers 58

- copy pattern 191
 - copy settings 190, 191
 - delay 63, 64
 - extension 58
 - extension count 62
 - extension interval 62
 - factory patterns 60
 - gate 58
 - time 61
 - guided tour 24
 - interval 58
 - key offset 68
 - key range 66
 - keyboard thru 65
 - latch mode 65
 - master parameters 58
 - MIDI out 56
 - MIDI song start 56
 - modes 57, 59
 - note value 60, 64
 - pattern 57, 60
 - naming 70
 - speed 60
 - resolution 58
 - status 59
 - user patterns 67
 - velocity 58, 61
 - Assign Group 146
 - Attack
 - envelope 143, 152, 159, 205
 - Audition
 - beats 46
 - button 32
 - preset 20
 - riff 171
 - Auxiliary Envelope 103, 152
- ## B
- B Effect Types 175, 176
 - Balance 123
 - Band-Pass Filter 119, 148
 - Bandwidth 121
 - Bank Number 21, 37
 - Bank Select Display 31
 - Banks 21
 - selecting 37
 - selecting via MIDI 38
 - Base Tempo 82
 - Basic Channel 46
 - setting keyboard & wheels to 72
 - Basic Setup 14
 - Basics, programming 99
 - Beats 43, 46
 - busy 49

- control knob 23
 - channel 46
 - initial setup 47
 - keys layout 51
 - keys offset 52
 - part chart 22
 - part group 54
 - part transpose 53
 - part velocity 52
 - played using trigger buttons 44, 76
 - playing 22
 - playing on a different MIDI
 - channel 23
 - presets, selecting 22
 - riffs 44
 - variation 50
 - control knob 23
 - velocity group 1-4 49
 - xpose group 1-4 49
 - Bend Range 84
 - Breath Controller 80
 - Bts Busy 49
 - Button
 - +/- channel 29
 - arpeggiator/beats 31
 - audition 31
 - compare 31
 - controllers 30
 - cursor 30
 - demo mode 35
 - global 30
 - home/enter 32, 43, 71, 83, 93
 - main 34
 - MIDI 31
 - MIDI panic 31
 - mix screen 34
 - mode select 36
 - multi 34
 - preset edit 32
 - save/copy 31, 187
- C**
- Calibrate Controllers 80
 - Category
 - instrument 40
 - preset 40
 - Center Frequency 121
 - Change
 - filter type 205
 - MIDI preset 95
 - preset 21, 37
 - Channel
 - +/- buttons 29
 - aftertouch on/off 74
 - arpeggiator 39
 - MIDI enable 94
 - pan 39
 - selection, MIDI 37
 - volume 38
 - Chorus 175, 185
 - width 199
 - Chorus, effect 185
 - Chorusing 144, 199
 - Clear Beats Part 44, 45
 - Clock
 - divisor 101
 - MIDI output enable 94
 - modulation 107
 - using external MIDI 82
 - Coarse Tuning 141, 198
 - Comb Filter 149
 - Comb Filter, effect 176, 185
 - Command Buttons
 - external preset selection 78
 - preset menu jump keys 36
 - selecting presets 77
 - trigger mode 36
 - Command Functions 36
 - Compare Button 31
 - Connection Instructions 14
 - Continuous Controller 124
 - Contour, envelope 101, 143
 - Control
 - data entry 29
 - effects multi mode 88
 - keys 45
 - volume 29
 - Controller
 - assigning real-time 94
 - calibration 80
 - footswitch 14, 15, 80
 - knobs 32, 33, 79, 125
 - modes 32
 - menu 71
 - menu button 30
 - MIDI 79, 124
 - MIDI #10 39
 - MIDI #7 38, 124
 - MIDI real-time 124
 - quick edit 33
 - realtime assignment 79
 - realtime knobs 32
 - standardized MIDI numbers 80
 - tempo 81
 - trigger buttons 72
 - Copy
 - layers 188
 - patchcord 189
 - preset 188
 - preset banks 191

- preset patchcords 190
- Crossfade
 - random 102
 - ranges 137
- Current Tempo 82
- Cursor
 - buttons 30
 - definition 30
- Curve
 - glide 147
 - keyboard velocity 73
 - master velocity 85
 - volume 199
- Cutoff Frequency 119, 202

D

- Damping, high frequency 176, 184
- Data Entry Control 29
- DC Offset, example 116
- DCA 123, 207
- Decay
 - effect A 90, 176
 - effects 176
 - envelope 199
- Default Assignment, beats 45
- Delay
 - arpeggiator 63, 64
 - effect B 91
 - effects 175, 176, 186
 - layer 144
 - LFO 156
 - master FXB 91
 - preset link 170
- Demo Sequences 19, 35
- Descending Arpeggiator 57
- Destinations, modulation 108, 159
- Device ID 96
- Diode Processor 110
- Display, viewing angle 92
- Distortion Effect 175, 186
- Double & Detune 144, 199
- Doubling, effect 185
- Dual Channel Beats 46
- Dual Tap, delay effect 186
- Duration, arp pattern 69
- Dynamic Filter 117
- Dynamic Range 247

E

- Echo Thru, Local Control on/off 72
- Edit All Layers Enable 92
- Edit Section 30

- Editing
 - arp user patterns 67
 - presets 197
- Effects
 - A type 175
 - B into effect A 182
 - B submix routing 91
 - B type 175
 - busses 173
 - by channel number 182
 - channel number setup 182
 - chorus 185
 - decay 176
 - delay 176, 186
 - description 184
 - diagram 161, 162, 164
 - distortion 186
 - doubling 185
 - dual tap delay 186
 - feedback 176, 186
 - flanger 185
 - FXA decay 90
 - FXA HF damping 90
 - FXB feedback 91
 - FxB->FxA 90, 177
 - global 181
 - HF damping 176
 - LFO rate 91, 176
 - master 173, 178, 181
 - A algorithm 89
 - B algorithm 90
 - FxB->FxA 178
 - LFO rate 91
 - mode, bypass 180
 - multi mode control 88, 180
 - panning delay 186
 - patchcords 165
 - preset 161, 177
 - processor 173
 - programming in the preset 177
 - returns 17
 - reverb 184
 - routing diagram 87
 - send amounts 173
 - sends 86
 - slapback 185
 - stereo delay 186
 - submix routing, A 90, 164, 165
 - type A 89, 163, 175, 176
 - type B 91, 164, 176
 - vibrato 186
 - wrong effect playing with beats 23
- Enable
 - controllers menu 71
 - MIDI channels 94
 - quick-edit mode 79
- Enter Button 32

Index

F

- Envelope
 - ADSR, programming 201
 - attack 143, 152, 159
 - auxiliary 152
 - decay 199
 - filter 151, 203, 204, 206
 - generator 101, 103
 - example 120
 - mode, factory 200
 - mode, filter 204
 - release 199
 - repeat 206
 - repeating 104
 - reverberation 184
 - volume 142, 143, 199, 201
 - Equal Temperment Tuning 168
 - Errors, data transmission 97
 - Extension
 - count, arpeggiator 62
 - interval, arpeggiator 62
 - External Clock, MIDI 82
- F**
- Factory
 - envelope mode 200
 - patterns, arpeggiator 60
 - Fc 150, 202
 - Feedback 176, 186
 - FXB 91
 - Fills, beats 44
 - Filter
 - 2-pole 120
 - 4-pole 120
 - 6-pole 120
 - bandpass 119, 148
 - changing type 205
 - comb 149, 176
 - definition 118
 - dynamic 117
 - envelope 103, 151, 203, 204
 - attack 205
 - envelope generator 151, 206
 - envelope mode 204
 - frequency 150, 151, 159, 202
 - highpass 118, 202
 - lowpass 118
 - mode 204
 - morph 122
 - notch 119
 - parametric 121
 - pole 120
 - programming 202
 - Q 150, 202
 - swept EQ 121
 - troubleshooting 207
 - tutorial 117
 - type 202, 205
 - changing 205
 - Z-plane 122, 123, 148
 - Fine Tuning 141, 198
 - Fingered Glide. solo mode 146
 - First Key, modulation 112
 - Flanger Effect 175, 185
 - Flashing Arp/Beats LED 82
 - Flip-Flop Processor 110
 - Foot Pedal
 - calibration 80
 - Footswitch 80, 101
 - connecting 14, 15
 - programming 74
 - Free Running LFO 154
 - Frequency
 - filter 151, 159
 - center 121
 - cutoff 119
 - instrument 140, 141
 - Frequency Modulation 100
 - Front Panel Knobs 32, 209
 - FX Cords 165
 - FXA Algorithm 177, 178
 - FXA Parameters 164
 - FXB -> FXA 177, 178, 182
 - FXB Algorithm 164, 177, 179
 - master 90
 - FXB Parameters 165
 - FXB Submix Routing 91
- G**
- Gain Processor 110
 - Gamelan Tuning 168
 - Gate 101
 - time 61
 - Generator
 - envelope 101
 - filter envelope 151, 206
 - noise & random 101
 - volume envelope 142
 - Glide 147
 - curve 147
 - key 101
 - rate 101, 147
 - Global
 - button 30
 - controller assignments 79
 - effects 178, 181
 - menu 83
 - Grooves, beat 44

- Group
 - assigning channels to a 146
 - beats 44
- H**
- High Frequency Damping 90, 176, 184
- Highpass Filter 118, 202
- Home Position 21
- Home/Enter Button 32, 43, 71, 83, 93
- I**
- Implementation Chart, MIDI 239, 241
- Initial
 - pan position 141
 - volume 141
- Instrument 123, 197
 - category 40
 - selecting 132
- Inverting LFO Waves 106
- J**
- Jam Presets 210
- Jump Buttons
 - preset edit menu 36
 - using 197
- Just C Tuning 168
 - description 169
- Just Intonation 168
- K**
- Key
 - glide 101
 - layout, beats 51
 - offset, arpeggiator 68
 - range
 - arpeggiator 66
 - keyboard 134
 - preset link 170
 - sync, arpeggiator 63
 - transpose 140
 - trigger 51
 - tuning 92
 - velocity 101
- Keyboard
 - beats trigger layouts 44
 - key 101
 - layering & splitting 208
 - pressure 101
 - range 133, 134
 - semitone transpose 72
 - splitting 208
 - thru, arpeggiator 65
 - transpose 140
 - on/off 145
 - tuning 168
 - 19-tone 168
 - equal temperament 168
 - gamelan 168
 - just C 168
 - Kirnberger 168
 - repeating octave 168
 - Scarlatti 168
 - Vallotti 168
 - Werkmeister III 168
 - velocity curve 73
 - velocity curve diagrams 229
- Keyboard/Knob Channel 72
- Kirnberger Tuning 168
- Knob
 - controller 125
 - keyboard channel 72
 - typical functions 209
- Knob Preset Quick-Edit 79
- Knobs Output MIDI 94
- L**
- Lag Amount, preset lag 111
- Lag Processor 109
- Latch
 - beats part 51
 - keys in beats 44
 - mode, arpeggiator 65
 - triggers 36
- Layer
 - copy 188
 - definition 130
 - instrument 99
 - presets 208
 - selecting 131
- Legato 145
- LFO 153
 - effect B 91
 - flanger 186
 - key sync 154
 - master FXB rate 91
 - rate 176
 - rate, effect 91
 - tricks & tips 154
 - trigger 106
 - variation 156
 - waveforms 105
 - waveshape 153
- Linking Presets 170, 208
- Local Control On/Off 72, 74, 75
- Looping Envelopes 104
- Low Frequency Oscillator 101, 105, 153
 - delay 156

Index
M

free running 154
sync 153, 154
variation 156
Lowpass Filter 118
example 120

M

Main Button 34

Master

arpeggiator 24
parameters 58
bend range 84
clock
current tempo 82
modulation 106
effects 88, 173, 178, 181
FXA algorithm 89
FXB algorithm 90
riff 46, 54
tempo, offset 171
velocity curve 85
volume control 29

Melody Solo Mode

high 145
last 145
low 145

MIDI

A-P assignments 79
bank select display 20, 31
channel
routing outputs by 86
tempo controller 81
channel inc/dec
using a footswitch 74
channel selection 37
clock
output enable 94
continuous controller
assignment 79
continuous controllers 101, 124
controller #7 38
device ID 96
enable 94
external clock 82
footswitch assign 74, 80
implementation chart 239, 241
in channels 94
input channels 94
knob transmit 94
menu button 31
mode 94, 173
multi mode 98
note triggers 36, 75, 76
omni mode 98
out, arp/beats 56
out, knob enable 94

pan control #10 39
panic button 31
poly mode 98
real-time controllers 124
receive program change 95
received channel commands 246
receiving sysex data 98
recording sysex data 98
send sysex data 98
sequencer, recording into an
external 72
song start 56
standardized controller numbers 80
sysex packet delay 97
sysex, send/receive 97, 98
velocity
curve input 85
curve output 73
Minimoog, solo mode 146
Mix Output 160
description 86
function 174
programmed in the preset 160
Mix Screen 34
Mod Wheel 101
Mode
arpeggiator 59
latch 65
controller 32
effects 180
factory envelope 200
filter envelope 204
MIDI 94, 173
mono 246
multi 98, 173, 246
non-transpose 145
omni 98, 180, 246
poly 98, 180, 246
solo 145
time-based envelope 204
Modulation 158
amplitude 100
clock 107
definition 100
destinations 108
note-on 108
polarity 158
processors 109, 113
random 102
routing 157
sources 101
sources & destinations 159
wheel 80
calibration 80
Momentary Footswitch 14
Mono Aftertouch 101

- Mono A-I, assign group 146
- Mono Mode 246
- Morph Filter 122
- Multi Button 34
- Multi Channel
 - arpeggiators 26
- Multi Mode 98, 173, 246
 - effects control 88
- Multichannel Volume/Pan Control 34
- Multiple Trigger, solo mode 145
- Multisetup
 - definition 34, 41
 - name 42
 - restoring 41
 - saving 42
 - send/receive 97
- Mute Beats 44, 45

- N**
- Name
 - multisetup 42
 - preset 130
 - user arp pattern 70
- Noise & Random Generators 101
- Non-Transpose Mode 145
- Notch Filter 119
- Note Value
 - arpeggiator 60, 64
- Note-On Modulation 108

- O**
- Offset, arpeggiator key 68
- Omni Mode 98, 180, 246
- Output
 - jack 14, 15, 16
 - jacks 17
 - mix 86, 160, 174
 - mono 14
 - routing 160
- Overall Tuning, adjusting 84

- P**
- Packet Delay, MIDI sysex 97
- Pan 123
 - channel 39
 - initial 141
 - preset link 170
- Panic Button, MIDI 31
- Panning Delay, effect 186
- Parametric Filters 121
- Part, beat 44
- Patchcord 102, 157
 - amount 124, 157
 - copy 189
 - example 113
 - routing 108
- Pattern
 - arpeggiator 57, 60
 - naming 70
 - repeat 69
 - speed 60
 - user 67
 - velocity 69
 - inc/dec
 - using a footswitch 74
- Pedal 101
 - connection 14, 15
 - programming 75
 - wiring diagram 15
- Performance Controllers 32, 36, 101
- Pink Noise, example 115
- Pitch Wheel 101
 - calibration 80
 - master bend range 84
 - range 160
- Pitch, shifting 198
- Pitchbend Range 160
- Play
 - solo layers 171
 - trigger buttons 76, 77, 78
- Polarity
 - modulation & LFO 158
 - ramp rate 112
- Pole, filter 120
- Poly All, assign group 146
- Poly Mode 98, 180, 246
- Poly, assign group 146
- Portamento 147
- Power Consumption 247
- Power Switch 14, 29
- Preset
 - architecture 130
 - audition 20
 - category 21, 40
 - change enable 95
 - changing 21
 - copy 188
 - edit button 32
 - editing 197
 - effects 161, 177
 - links 170, 171, 208
 - menu jump buttons 36
 - MIDI changes 95
 - naming 130
 - random 195
 - selecting 20, 37

- selecting via command buttons 36, 77
 - tempo offset 171
 - user 97
 - view screen 37
 - Preset Lag Processor 111
 - Preset Ramp Processor 111
 - Processor
 - 4x gain 110
 - absolute value 109
 - diode 110
 - effect 173
 - flip-flop 110
 - modulation 113
 - preset lag 111
 - preset ramp 111
 - quantizer 110
 - Program Change
 - receive enable 95
 - Program->Preset Map 95
 - send/receive 97
 - Programmable Knobs 79
 - Programming Basics 99
- Q**
- Q 119, 149, 150, 202, 205
 - Quantized, arp sync 63
 - Quantizer 110, 116
 - example 115
 - Quick Edit
 - enabling 79
 - mode 33
- R**
- Ramp Rate 112
 - Random
 - creating presets 195
 - crossfade 102
 - crossswitch 138
 - generator, noise and 101
 - modulation sources 102
 - Range
 - arp extension count 62
 - key 133, 134
 - keyboard 133
 - pitchbend 160
 - velocity 135
 - Rate
 - effect, LFO 91, 176
 - glide 147
 - LFO 154
 - master FXB LFO 91
 - Rate/Level Envelopes 103
 - Realtime Control of Arps 58
 - Realtime Controller 72
 - assignment 79, 94
 - crossfading 137
 - tutorial 124
 - Realtime Crossfade 137
 - Receive Program Change 95
 - Receiving MIDI SysEx Data 98
 - Record
 - MIDI sysex data 98
 - Rectifier 109
 - Release
 - envelope 199
 - velocity 101
 - Rename, arpeggiator pattern 70
 - Repeat
 - arpeggiator pattern 69
 - Resonance, filter 119, 149, 150, 205
 - Restoring Multisetups 41
 - via MIDI command 41
 - Return Signal 16
 - Reverb 175, 184
 - envelope 184
 - Riff
 - assignment 171
 - controllers 55
 - playing 20, 31
 - tempo 55
 - ROM Card Identifier 21
 - Routing
 - FXA submix 90, 164, 165
 - FXB submix 91
 - modulation 157
 - output 86, 160, 173
- S**
- Save
 - arp menu parameters 41
 - arp parameters 43
 - controllers menu parameters 41
 - global menu parameters 41
 - MIDI menu parameters 41
 - multiple arp setup 28
 - multisetup 42
 - preset 187
 - preset/volume/pan/arp assignments 41
 - Save/Copy
 - button 31, 187
 - menu 187
 - Scaling
 - MIDI Velocity In 85
 - MIDI Velocity Out 73
 - Scarlati Tuning 168

- Screen View Buttons 34
 - Screen Viewing Angle 92
 - Selecting
 - menus with jump buttons 197
 - presets 20, 37
 - using command buttons 36, 77
 - Semitone
 - transpose keyboard by 72
 - Send
 - amount 173
 - FXA 90, 164, 165
 - FXB 91
 - effect 86
 - preset effect 160
 - Setup
 - basic 14
 - performance 15
 - studio 16
 - Signal Path 123, 173
 - Slapback 185
 - Solo Layer 171
 - Solo Mode 145
 - Sound Navigator 40
 - selecting instruments 132
 - Sound Start 144
 - Sources, modulation 159
 - Specifications, technical 247
 - Split Keyboard 170, 208
 - using links 208
 - Stack
 - layers 135
 - presets 170
 - Standardized MIDI Controller
 - Numbers 80, 241
 - Start/Stop Beats 44, 45
 - Step-By-Step Preset Programming 197
 - Stereo Delay, effect 186
 - Stolen Voices 146
 - Studio Setup 16
 - Sub Output Jacks 17
 - Submix Routing
 - FXB 91
 - Summing Amp 109, 110
 - Summing Nodes 100
 - Swept EQ Filter 121
 - Switch Processor 109, 113
 - Sync
 - arp key 63
 - LFO 153, 154
 - MIDI song start 56
 - Synth Solo Mode
 - high 146
 - last 145
 - low 146
 - System Exclusive
 - device ID 96
 - packet delay 97
 - send arp data 66
 - send data 98
- T**
- Tap Tempo 82
 - using a footswitch 74
 - Technical Specifications 247
 - Tempo
 - base 82
 - change via MIDI controller 81
 - controller 81
 - offset 171
 - Tempo-based Envelope 104, 142, 151, 200
 - Time
 - arpeggiator gate 61
 - master FXB delay 91
 - Time-based Envelope 103, 142, 151, 200, 204
 - Transmission Errors 97
 - Transmit MIDI Clock 94
 - Transmit MIDI, knob 94
 - Transpose 84, 140, 141
 - arpeggiator 62
 - beat part 53
 - keyboard 72
 - preset link 170
 - Trig Hold, beats 45
 - Trigger Buttons 75, 76
 - controlling multiple arps 22, 26
 - Trigger Channel 46
 - Trigger Key 44
 - Trigger Mode 36, 76, 77, 78
 - Troubleshooting 207
 - Tune 84
 - Tuning 141, 198
 - 19-tone 168
 - coarse 198
 - equal temperament 168
 - fine 198
 - gamelan 168
 - just C 168
 - key 92
 - keyboard 168
 - Kirnberger 168
 - repeating octave 168
 - Scarlatti 168
 - Vallotti 168
 - Werkmeister 168

Tutorial
 arpeggiator 24
 beats 22
 filter 117
 synth programming 197

U

Unlatch Beats Part 51

User

 banks 21
 key tuning 92
 presets 97
 tuning tables 92

User Pattern

 arpeggiator 67
 naming 70
 repeat 69
 velocity 69

V

Vallotti Tuning 168

Variation

 beats 50
 LFO 156

Velocity

 arpeggiator 61
 crossfade 135, 136
 curve, keyboard 73
 curve, master 85
 key 101
 keyboard curve charts 229
 master curve charts 232
 preset link 170
 release 101
 user pattern 69

Vibrato, effect processor 186

Viewing Angle, screen 92

Voices, stolen 146

Volume

 channel 38
 control 29
 control #7 38
 curve 199
 envelope 103, 123, 142, 143, 199, 201
 preset link 170

W

Waveform

 instrument list 216
 inverting 106
 LFO 105

Werkmeister Tuning 168

Wheel

 modulation 101
 pitch 101
Width, chorus 199

Z

Z-Plane Filter 122, 123, 148