SERVICE MANUAL

Matrix-6



Oberheim.

A Division of ECC Development Corporation



Oberheim

Matrix-6

**6-Voice Polyphonic MIDI Synthesizer
SERVICE MANUAL**

Preliminary Edition - February 1986

©1986 OBERHEIM - A Division of E.C.C. Development Corporation
11650 Olympic Boulevard, Los Angeles, California 90064

All Rights Reserved. Reproduction in Whole or in Part is Prohibited
Without Permission. Oberheim, The Oberheim Logo, MATRIX-6,
MATRIX-12, XPANDER, Xk, OB-8, DSX, DMX, and DX are trademarks of
E.C.C. Development Corporation.

MATRIX-6 SERVICE MANUAL

PRELIMINARY EDITION - February, 1986

00 MATRIX-6



CALIBRATIONS

1. **TUNE** - While in MASTER EDIT, pressing the **B** button puts the MATRIX-6 into AutoTune. The cycle takes approximately two to three seconds to complete, during which time the display reads "*TUNING...*". While in TUNE mode, the processor is tuning the MATRIX-6's three High Frequency Oscillators (HFOs).
2. **CALIBRATE** - While in MASTER EDIT, pressing the **A** button puts the MATRIX-6 into Parameter Select mode. While in this mode, call up parameter 52 and the display should read "*52 CALIBRATE*". Now press the **D** button. This will put the MATRIX-6 into VALUE mode and the display will read "*READY?*". Press the YES button on the Keypad - the display will blank out during the Calibration routine. When the process is finished, the display will return to read "*52 CALIBRATE*".

The CALIBRATE function calibrates the three HFOs as well as the VCF Frequency, Pulse Widths, Resonance amount and VCA2 level on each voice. If the MATRIX-6 encounters any problems while tuning the voices, it will display which voice and the section of that voice that is having the problem. To display tuning failures enter CALIBRATE mode and, with the display blank, press and hold the **C** button until the display returns to "*52 CALIBRATE*".

If the MATRIX-6 tunes all six voices without encountering any problems, the display will remain blank during the tuning process. When problems are encountered, the display will indicate which of the four sections of the tuning process and the voice or voices that are bad. Failures in any of the four sections of the tuning process are displayed with the following messages:

"BAD OSC **"	for problems with the HFOs.
"BAD WAVE **"	for oscillator waveform problems.
"BAD RES **"	for resonance problems.
"BAD VCF **"	for filter problems.

The two stars in each message represent a two digit number that indicates which voice or voices have failed that section of the Calibration. The number is a

decimal equivalent of a binary number, with each digit in the binary number corresponding to a particular voice. For example, if the display reads "**BAD OSC 63**", it would be broken down like this:

Decimal number -	63					
Value of binary digits -	32	16	8	4	2	1
Binary equivalent -	1	1	1	1	1	1
Corresponding bad voices -	V6	V5	V4	V3	V2	V1

So if the display reads "**BAD OSC 63**" this means that all six of the voices have failed the Oscillator section of the tuning. Now if the display reads "**BAD WAVE 24**", it would be broken down like this:

Decimal number -	24					
Value of binary digits -	32	16	8	4	2	1
Binary equivalent -	0	1	1	0	0	0
Corresponding bad voices -	--	V5	V4	--	--	--

With "**BAD WAVE 24**", Voices four and five have failed the waveform Calibration.

Note: When trying to display the tuning failures, be sure to watch the display, because the failure displays are only shown for a short time.

When tuning failures are encountered, run the CALIBRATE function two more times. If there are no more failures after the third attempt, Tuning is OK. This will happen most often when the unit is cold.

3. DAC CALIBRATION - To enter this mode, the MATRIX-6 must be in MASTER EDIT parameter select mode. With parameter "52 CALIBRATE" displayed, first press and hold the **D** button. Next, press and hold the **C** button then press and hold the **B** button. The MATRIX-6 is now in DAC CALIBRATION mode and all three held buttons can be released. The display should read "**TUNING...**".

Caution: Be careful not to short any pins when zeroing the DAC.

With a DVM in the millivolt range, set the DAC output to 0.000 volts. The DAC output is measured at pin 6 of U712 on the Voice board. Connect the DVM ground to the ground leg of C13 (the leg toward rear of unit). C13 is directly behind U704. Adjust the DAC output to zero by turning the trimmer located directly behind U712. To exit DAC CALIBRATION mode press the MASTER button.

Note: After zeroing the DAC, the MASTER EDIT parameter number "52 CALIBRATE" must be preformed.

4. HFO CALIBRATION - To enter the High Frequency Oscillator Calibration mode, the MATRIX-6 must be in the MASTER EDIT parameter select mode.

Select parameter number "52 CALIBRATE". Now press and hold the C button, then press and hold the B button. The MATRIX-6 is now in HFO CALIBRATION mode and the held buttons can be released.

Caution: when adjusting the coils of the HFO's, take care not to damage the very fragile core.

When adjusting HFOs, be sure to remove adjusting tool from the core of the coil before taking the frequency measurement.

There are three High Frequency Oscillators which need to be adjusted when Calibrating HFO's. The adjustments are made first at L2, then L3 and last L1. Use a Frequency Counter to set the frequency of all three Oscillators between 3.500 and 3.505 MegaHZ. After L1 is set, the frequency of L2 and L3 should be double checked to make sure they have not changed.

To adjust L2 connect Frequency Counter to pin 14 of U732.

To adjust L3 connect Frequency Counter to pin 14 of U733.

To adjust L1 connect Frequency Counter to pin 14 of U736.

After adjusting all three HFOs, exit HFO CALIBRATION mode by pressing MASTER button.

Note: After Calibrating the HFOs, the MASTER EDIT parameter "52 CALIBRATE" must be preformed.

5. PROCESSOR RESET & INITIALIZE - First, make sure the AC power is turned off. Press and hold the red STORE button. Turn the AC power on and the display should have one or two characters flickering in the display. Now release the STORE button and the display will go blank for a few seconds. When the display resets, it will recall patch number "00". Although the unit will display patch "00", it will be playing the initialized patch.

POWER SUPPLY

<u>VOLTAGE</u>	<u>TOLERANCES</u>	<u>J03 PIN # *</u>
-5	+/- 200mv	1
+5A	+/- 200mv	3,4
+5B	+/- 200mv	5,6
+12	+/- 500mv	7,8
-12	+/- 500mv	9,10
-42	-41v to -45v	n/a **

* J03 is the connector located on the Power Supply board.

** The -42 volt supply is measured on the noncomponent side of the Display Board, at the point labeled "-42", located directly behind the fluorescent display.

MEMORY VOLTAGE

The memory voltage is measured at pin 28 of U7 or U8.

Power off: The voltage should range from +3 to +2.4 volts. If the voltage goes below +2.4, the MATRIX-6 may lose all or part of its memory.

Power on : The voltage should be 4.4 volts +/- 60mv.

TAD

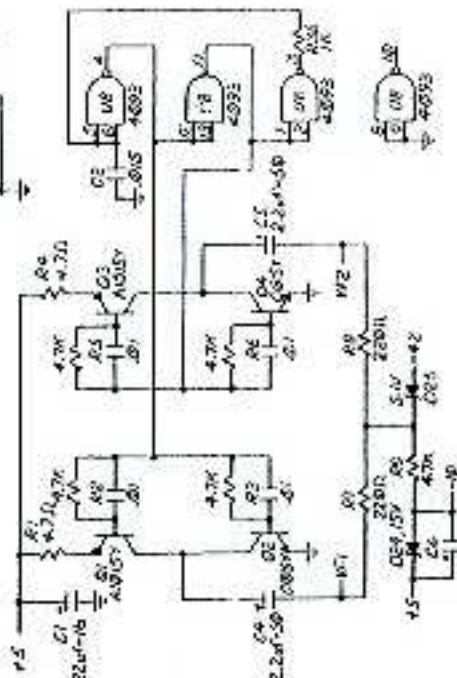
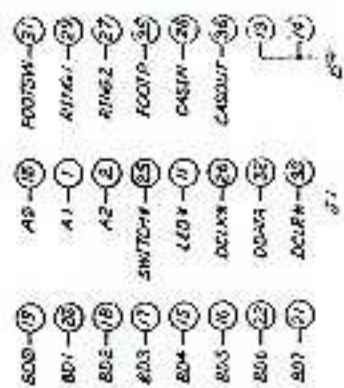
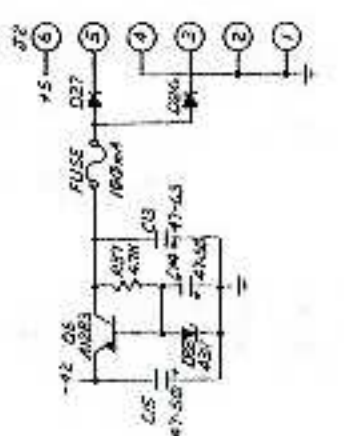
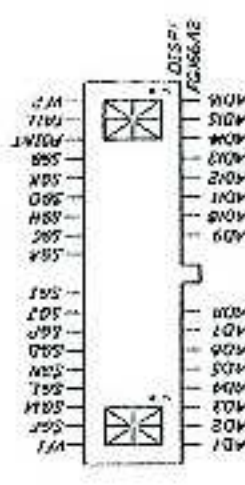
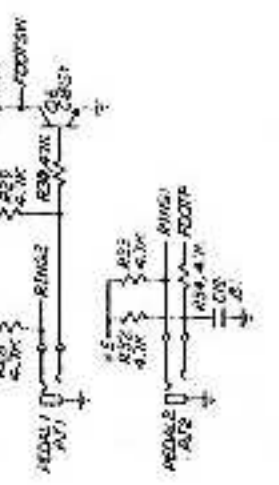
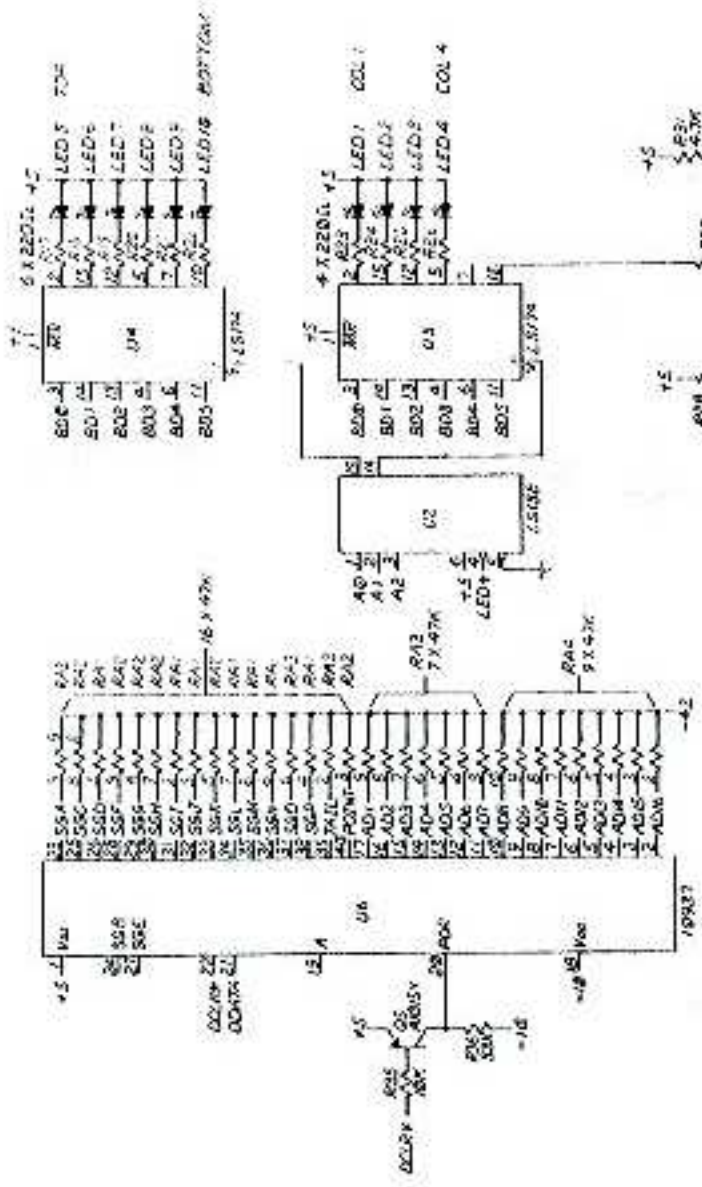

OVERHEAT-DIV. OF SEC. DEV. CORP.
-SCHEMATIC-
MG SW/ DISPLAY BOARD

INITIAL RELEASE	18-15-58
REVISION	
A	

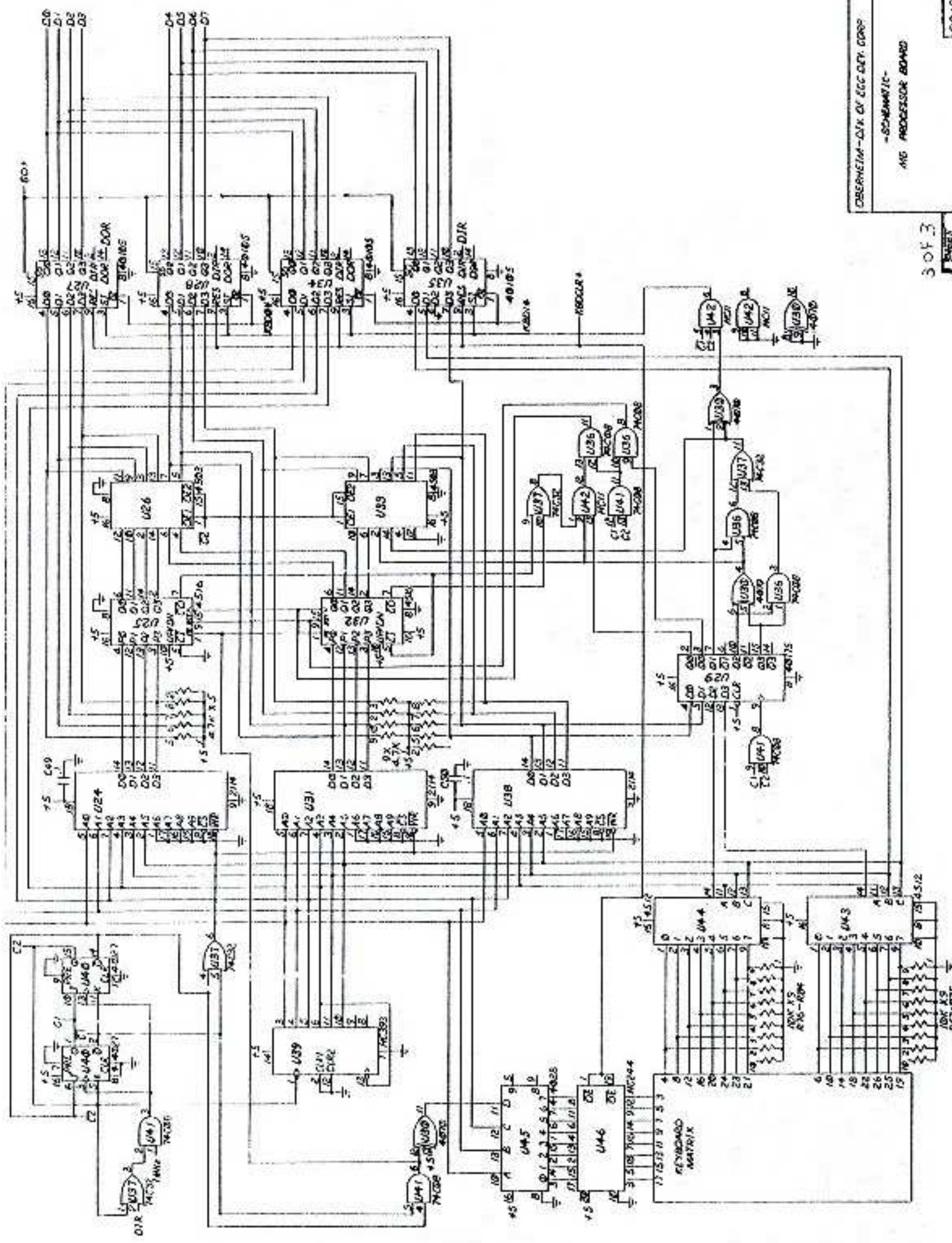

OSBERHEIM-DIA. DV. ECC. DEF. CORR.
-SCHWAMMIG-
MIS. PROCESSOR BOARD

3043

2019

